

Burrows Avenue Pumping Station Upgrades

Appendix A



RTU #: TBC
 Phone #: TBC
 Location: 2080 Burrows Avenue (West of Intersection of Avery Drive and Burrows Avenue)

Burrows lift RTU panel. It contains 3 pumps with two DP level transmitters and two precision digital displays on the door for pump control.

The RTU is 24 VDC Digital Inputs.

This station has been designed to allow for RTU pump control with setpoint controllable through Central control.

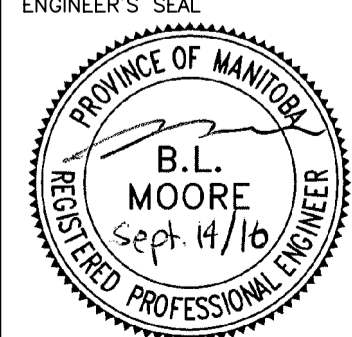

B.M. ELEV.		DESIGNED BY BLM				THE CITY OF WINNIPEG WATER AND WASTE DEPARTMENT	BURROWS AVE. LIFT STATION - RTU PANEL	CITY DRAWING NUMBER 1-01211-A0201-001-00-B				
		DRAWN BY MS						RELEASED FOR CONSTRUCTION DATE	CONSULTANT PROJECT NO. 163523	TITLE PAGE STATION INFORMATION	SHEET 1 OF 23	
		CHECKED BY BLM									HOR. SCALE NONE VERTICAL	1
		APPROVED BY										
1	ISSUED FOR BID OP. 803-2016	SEP 14/16	BLM									
NO.	REVISIONS	DATE	BY	DATE								

BURROWS LIFT STATION RTU DRAWINGS

FILENAME	SH	SX	DESCRIPTION	DRAWING NUMBER	FILEDATE
Title	01	24	Station information	1-0121L-A0201-001-00-B	9/14/2016
Table of Contents	02	24	Drawing list	1-0121L-A0202-001-00-B	9/14/2016
Power & Fuse distribution	03	24	Fuse list	1-0121L-A0203-001-00-B	9/14/2016
Digital INPUTS 01-06	04	24	Lockout / Hi & Hi Hi wet well / Stn fld / Low temp / Seal H2O	1-0121L-A0204-001-00-B	9/14/2016
Digital INPUTS 07-08	05	24	120 VAC & 600 VAC power fail alarms	1-0121L-A0205-001-00-B	9/14/2016
Digital INPUTS 09-10, 24 VDC PWR & UPS	06	24	UPS alarms & power distribution	1-0121L-A0206-001-00-B	9/14/2016
Digital INPUTS 11-13	07	24	Fault, Spare	1-0121L-A0207-001-00-B	9/14/2016
Digital INPUTS 14-16	08	24	Lvl sensor fail, Magmeter fail, spare	1-0121L-A0208-001-00-B	9/14/2016
Digital INPUTS 17-24	09	24	Pump L01 feedback loops	1-0121L-A0209-001-00-B	9/14/2016
Digital INPUTS 25-32	10	24	Pump L02 feedback loops	1-0121L-A0210-001-00-B	9/14/2016
Digital INPUTS 33-40	11	24	Pump L03 feedback loops	1-0121L-A0211-001-00-B	9/14/2016
Digital INPUTS 41-48	12	24	Backup Power Status	1-0121L-A0212-001-00-B	9/14/2016
Digital INPUTS 49-56	13	24	Security, Spares	1-0121L-A0213-001-00-B	9/14/2016
Counter INPUTS	12	24	Flow Meter FIT-L201	1-0121L-A0214-001-00-B	9/14/2016
Digital OUTPUTS 01-08	13	24	Pump RTU mode call to runs, Alarm Status	1-0121L-A0215-001-00-B	9/14/2016
Digital OUTPUTS 09-16	14	24	RTU mode, local mode, fail to local	1-0121L-A0216-001-00-B	9/14/2016
LT1-Level controller pump runs	15	24	Precision digital (PD6000)	1-0121L-A0217-001-00-B	9/14/2016
LT2-Level controller pump runs	18	24	Precision digital (PD6000)	1-0121L-A0218-001-00-B	9/14/2016
Pump run contacts	16	24	Pump L01 & L02 Runs	1-0121L-A0219-001-00-B	9/14/2016
Pump run contacts	20	24	Pump L03 Run	1-0121L-A0220-001-00-B	9/14/2016
Analog INPUTS 01-04	17	24	Level feedback	1-0121L-A0221-001-00-B	9/14/2016
Analog INPUTS 05-08	18	24	Flow Meter, Temperature	1-0121L-A0222-001-00-B	6/12/2012
Panel Door Layout	22	24	Door layout	1-0121L-A0223-001-00-B	6/12/2012



B.M. ELEV.	DESIGNED BY	BLM
	DRAWN BY	MS
	CHECKED BY	BLM
	APPROVED BY	
	HOR. SCALE	NONE
	VERTICAL	
1 ISSUED FOR BID OP. 803-2016	SEP 14/16	BLM
NO. REVISIONS	DATE	BY

RELEASED FOR CONSTRUCTION

DATE

ENGINEER'S SEAL

CONSULTANT PROJECT NO. 163523

THE CITY OF WINNIPEG
WATER AND WASTE DEPARTMENT

BURROWS AVE. LIFT STATION - RTU PANEL

TABLE OF CONTENTS
DRAWING LIST

CITY DRAWING NUMBER	1-0121L-A0202-001-00-B
SHEET OF	2 OF 23
2	

120 VAC, 15 A
Panel 1, CCT.?

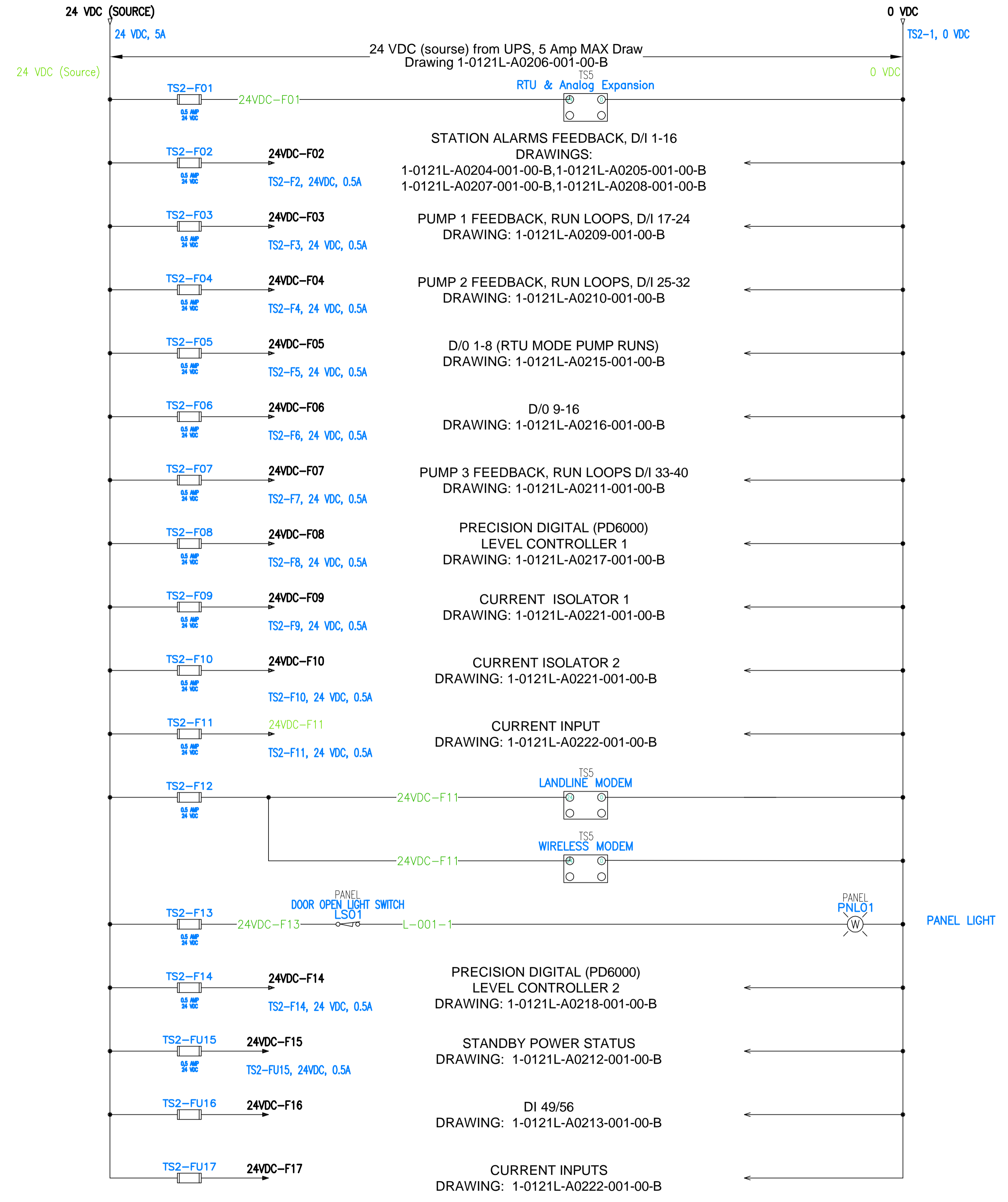
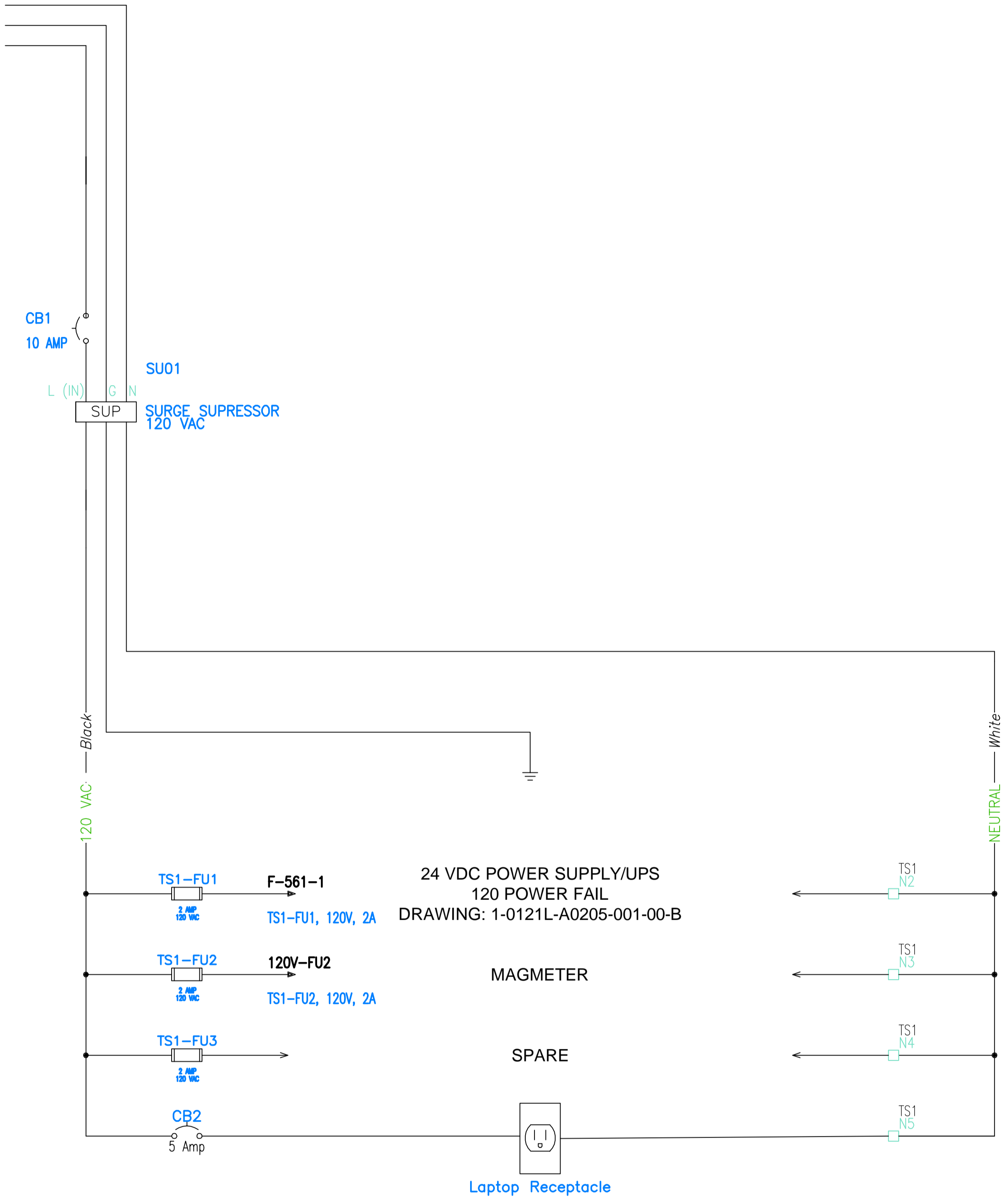

B.M. ELEV.	DESIGNED BY BLM				BURROWS AVE. LIFT STATION - RTU PANEL POWER DISTRIBUTION FUSE LIST	CITY DRAWING NUMBER 1-0121L-A0203-001-00-B SHEET 3 OF 23
	DRAWN BY MS					
	CHECKED BY BLM	RELEASED FOR CONSTRUCTION	CONSULTANT PROJECT NO. 163523			
	APPROVED BY	DATE				
1 ISSUED FOR BID OP. 803-2016	SEP 14/16	BLM				
NO. REVISIONS	DATE	BY	DATE			

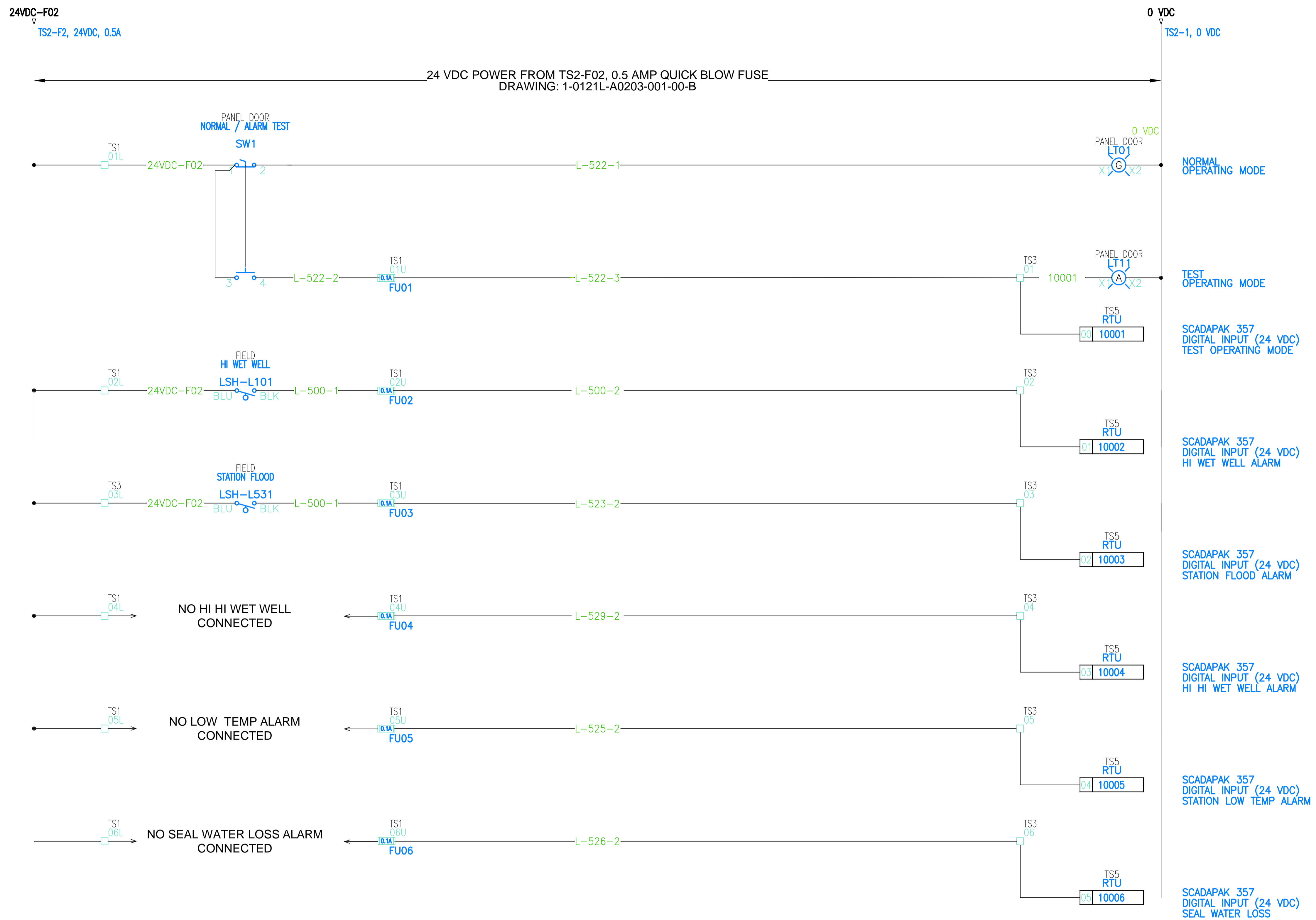

B.M. ELEV.	DESIGNED BY	BLM
	DRAWN BY	MS
	CHECKED BY	BLM
	APPROVED BY	
	HOR. SCALE	NONE
	VERTICAL	
1 ISSUED FOR BID OP. 803-2016	SEP 14/16	BLM
NO. REVISIONS	DATE	BY

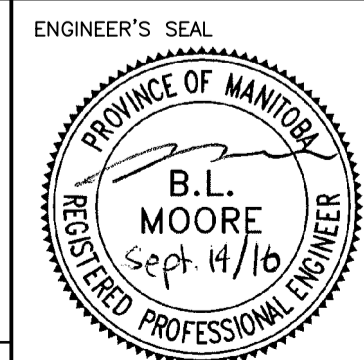

BURROWS AVE. LIFT STATION - RTU PANEL

DI 01-06

LOCKOUT / HI & HI HI WET WELL / STN FLD / LOW TEMP / SEAL H2O

CITY DRAWING NUMBER: 1-0121L-A0204-001-00-B

SHEET 4 OF 23

CONSULTANT PROJECT NO. 163523

4

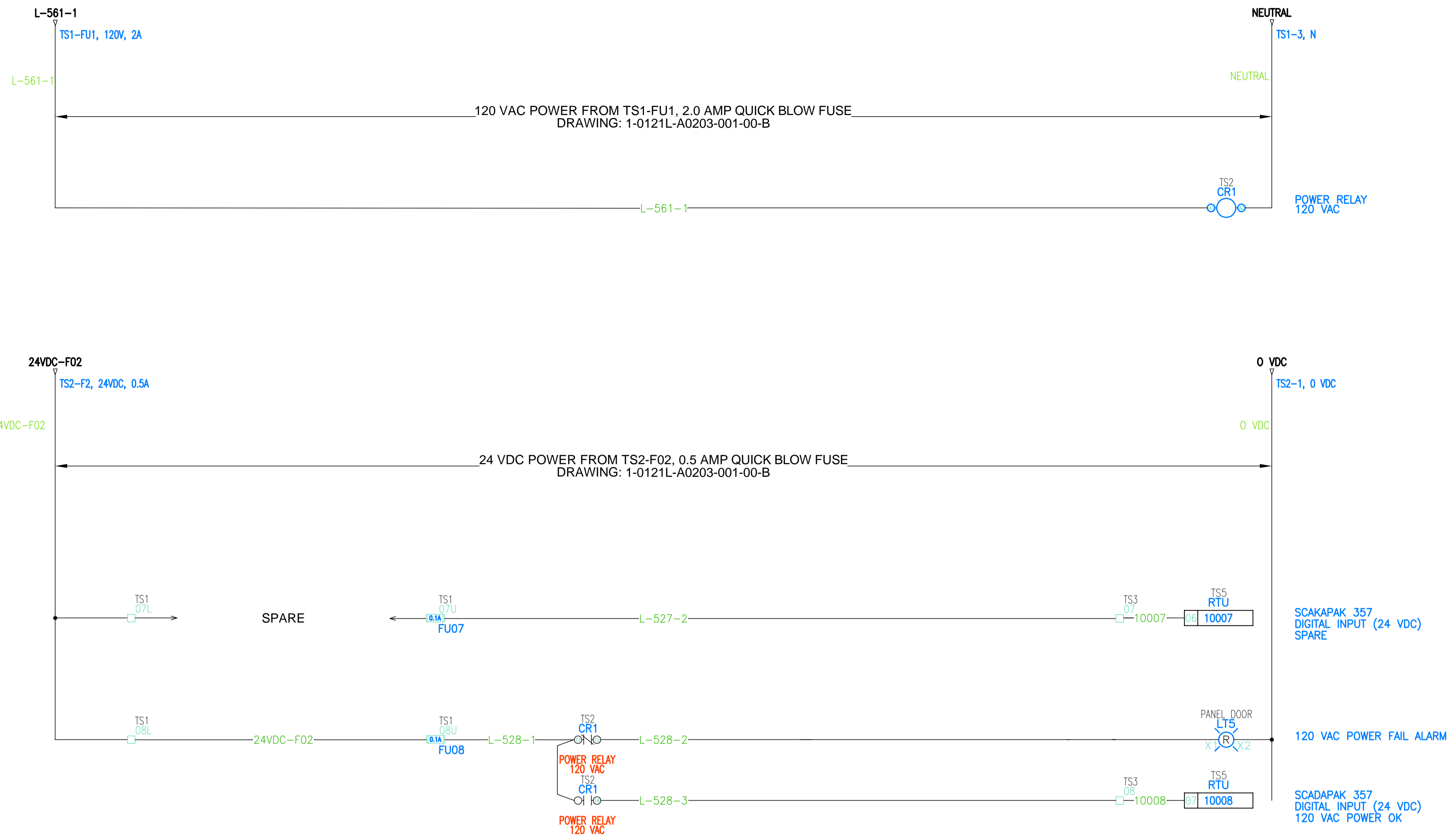

DESIGNED BY BLM					
DRAWN BY MS				BURROWS AVE. LIFT STATION - RTU PANEL	
CHECKED BY BLM				DI 07-08	
APPROVED BY				120 VAC & 600VAC POWER FAIL ALARMS	
HOR. SCALE NONE		RELEASED FOR CONSTRUCTION	CONSULTANT PROJECT NO. 163523	CITY DRAWING NUMBER 1-0121L-A0205-001-00-B	
VERTICAL		DATE		SHEET 5 OF 23	
NO. REVISIONS		DATE	BY	DATE	5

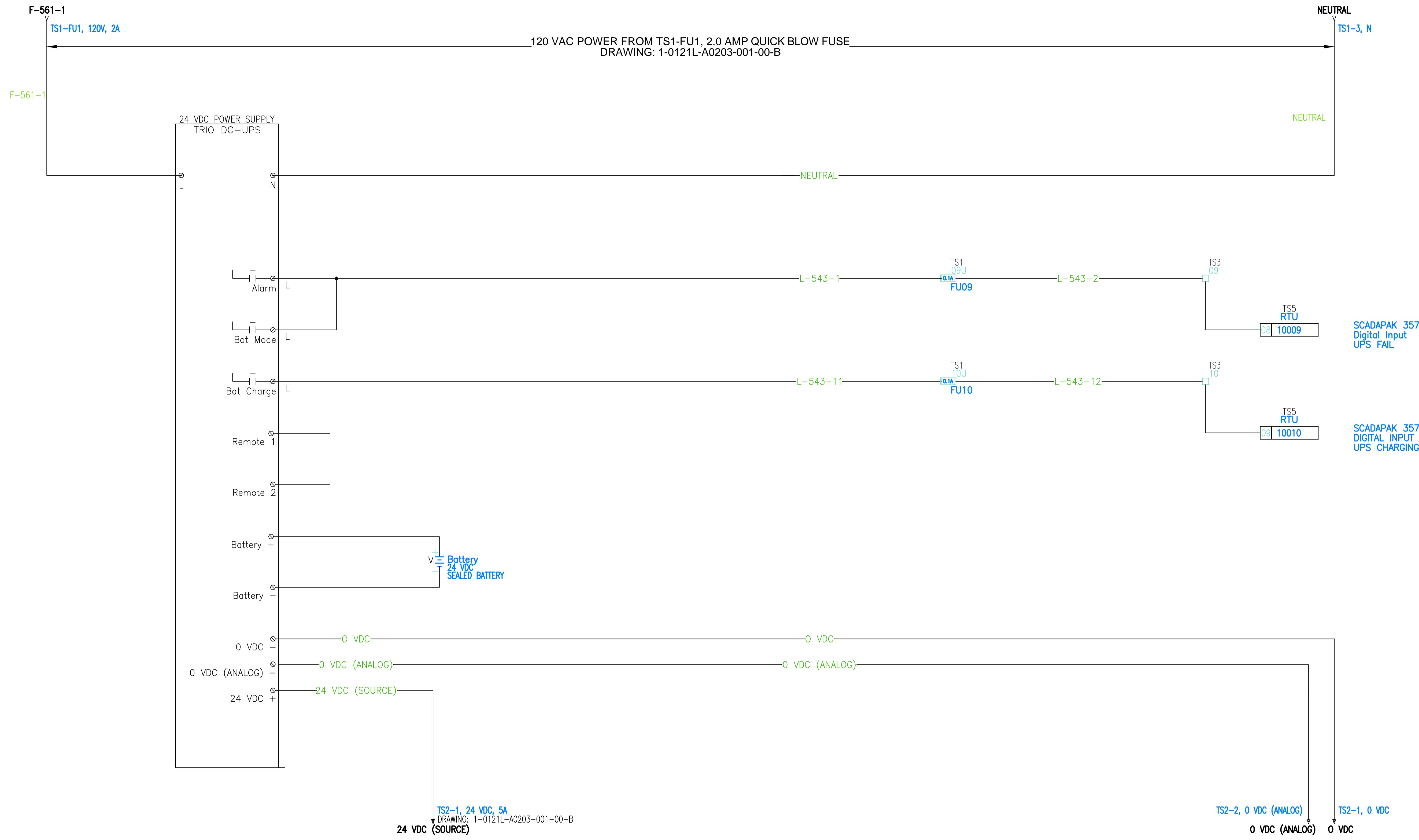

B.M. ELEV.	DESIGNED BY	BLM
	DRAWN BY	MS
	CHECKED BY	BLM
	APPROVED BY	
	HOR. SCALE	NONE
	VERTICAL	
1 ISSUED FOR BID OP. 803-2016	SEP 14/16	BLM
NO. REVISIONS	DATE	BY DATE

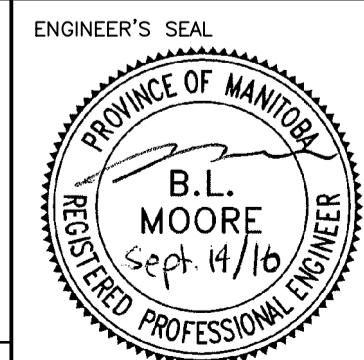

THE CITY OF WINNIPEG
WATER AND WASTE DEPARTMENT

BURROWS AVE. LIFT STATION - RTU PANEL

DI 09-10
UPS ALARMS & POWER DISTRIBUTION

CITY DRAWING NUMBER
1-0121L-A0206-001-00-B

SHEET 6 OF 23

6

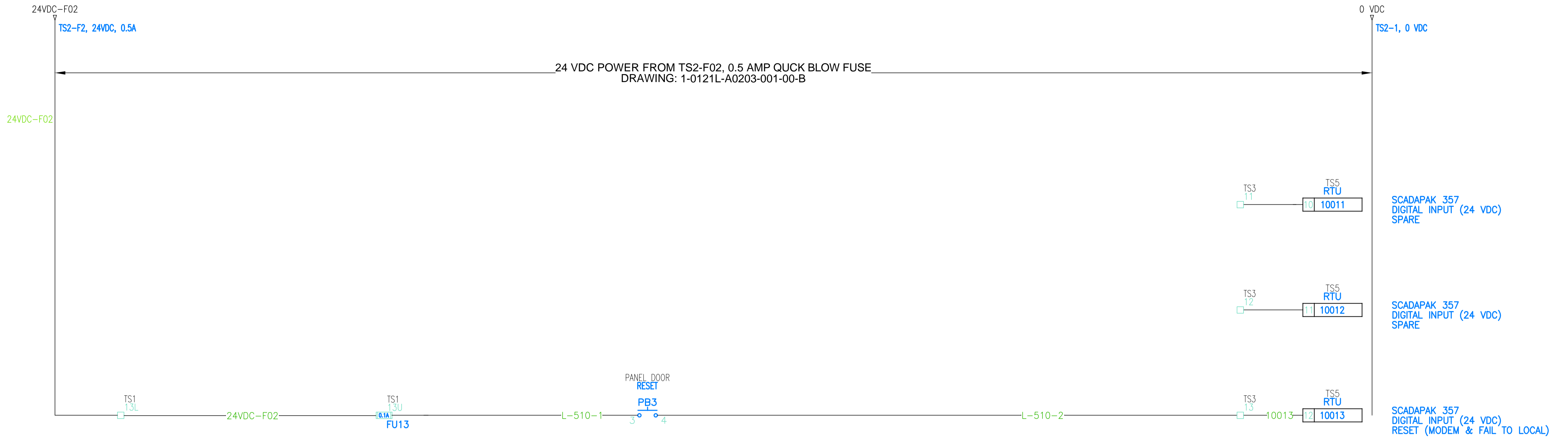

B.M. ELEV.		DESIGNED BY BLM				BURROWS AVE. LIFT STATION - RTU PANEL DI 11-13 LOCAL RTU AND FAIL TO LOCAL LOOPS	CITY DRAWING NUMBER 1-0121L-A0207-001-00-B
		DRAWN BY MS					SHEET 7 OF 23
		CHECKED BY BLM					
		APPROVED BY					
		HOR. SCALE NONE	RELEASED FOR CONSTRUCTION	CONSULTANT PROJECT NO. 163523			
		VERTICAL	DATE				
NO.	REVISIONS	DATE	BY	DATE			
1	ISSUED FOR BID OP. 803-2016	SEP 14/16	BLM				

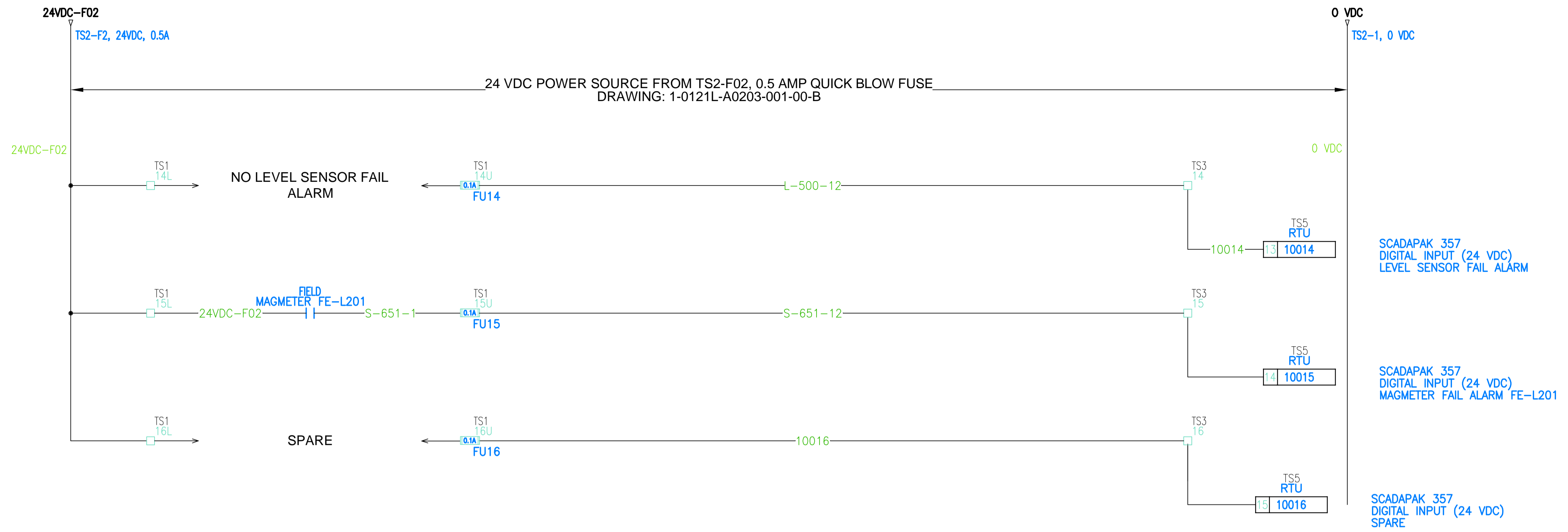

B.M. ELEV.	DESIGNED BY	BLM
	DRAWN BY	MS
	CHECKED BY	BLM
	APPROVED BY	
	HOR. SCALE	NONE
	VERTICAL	
1	ISSUED FOR BID OP. 803-2016	SEP 14/16 BLM
NO.	REVISIONS	DATE BY DATE

DILLON CONSULTING

RELEASED FOR CONSTRUCTION

DATE

ENGINEER'S SEAL

PROVINCE OF MANITOBA

B.L. MOORE

Sept. 14/16

REGISTERED PROFESSIONAL ENGINEER

CONSULTANT PROJECT NO. 163523

THE CITY OF WINNIPEG
WATER AND WASTE DEPARTMENT

BURROWS AVE. LIFT STATION - RTU PANEL

DI 14-16
LEVEL SENSOR FAIL, MAGMETER FAIL,
SPARE

CITY DRAWING NUMBER
1-0121L-A0208-001-00-B

SHEET 8 OF 23

8



B.M. ELEV.	DESIGNED BY	BLM
	DRAWN BY	MS
	CHECKED BY	BLM
	APPROVED BY	
	HOR. SCALE	NONE
	VERTICAL	
1 ISSUED FOR BID OP. 803-2016	SEP 14/16	BLM
NO. REVISIONS	DATE	BY

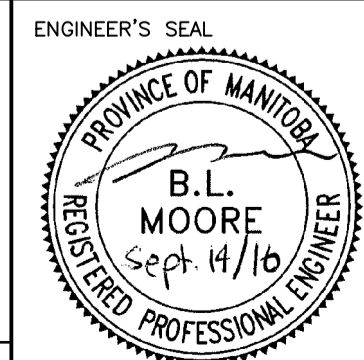

THE CITY OF WINNIPEG
WATER AND WASTE DEPARTMENT

BURROWS AVE. LIFT STATION - RTU PANEL

DI 17-16
PUMP L01 FEEDBACK LOOPS

CITY DRAWING NUMBER
1-0121L-A0209-001-00-B

SHEET 9 OF 23

9

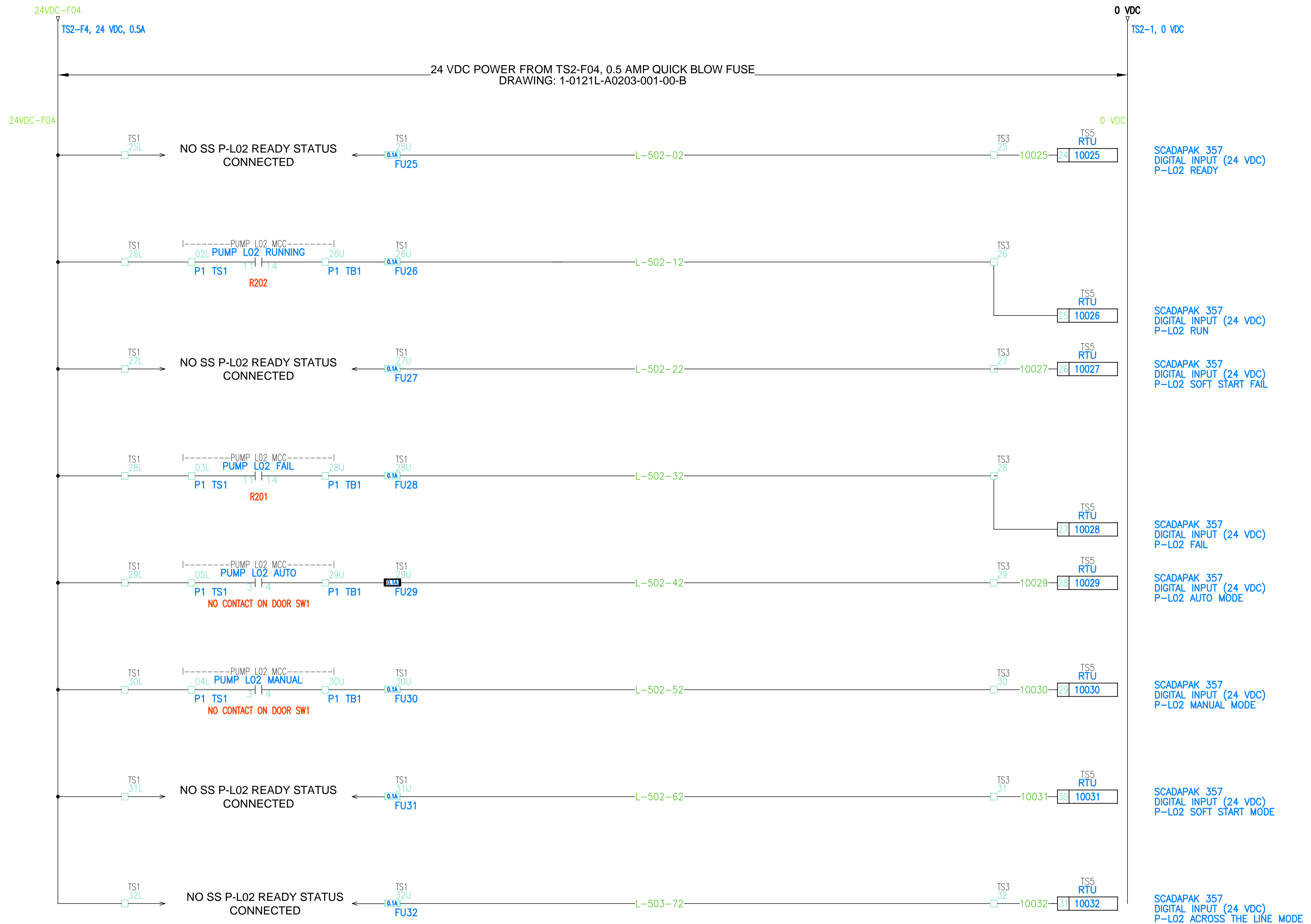

B.M. ELEV.	DESIGNED BY	BLM
	DRAWN BY	MS
	CHECKED BY	BLM
	APPROVED BY	
	HOR. SCALE	NONE
	VERTICAL	
1 ISSUED FOR BID OP. 803-2016	SEP 14/16	BLM
NO. REVISIONS	DATE	BY

RELEASED FOR CONSTRUCTION
 DATE

ENGINEER'S SEAL

 CONSULTANT PROJECT NO.
 163523

BURROWS AVE. LIFT STATION - RTU PANEL
 DI 25-32
 PUMP L02 FEEDBACK LOOPS
 CITY DRAWING NUMBER
 1-0121L-A0210-001-00-B
 SHEET 10 OF 23
 10

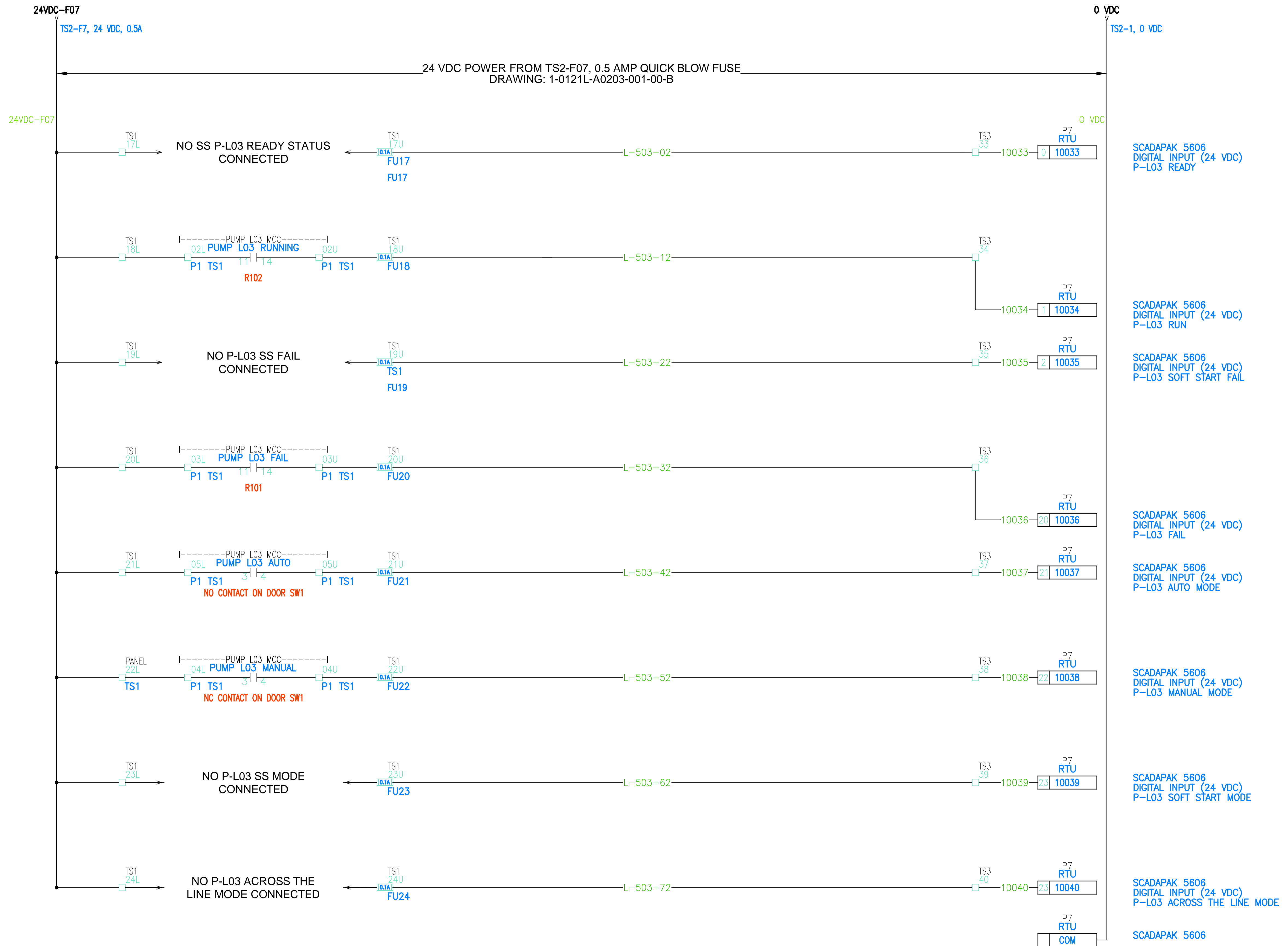

B.M. ELEV.	DESIGNED BY	BLM
	DRAWN BY	MS
	CHECKED BY	BLM
	APPROVED BY	
	HOR. SCALE	NONE
	VERTICAL	
1 ISSUED FOR BID OP. 803-2016	SEP 14/16	BLM
NO. REVISIONS	DATE	BY

DILLON CONSULTING

RELEASED FOR CONSTRUCTION

DATE

ENGINEER'S SEAL

PROVINCE OF MANITOBA

B.L. MOORE

Sept. 14/16

REGISTERED PROFESSIONAL ENGINEER

CONSULTANT PROJECT NO. 163523

THE CITY OF WINNIPEG
WATER AND WASTE DEPARTMENT

BURROWS AVE. LIFT STATION - RTU PANEL

DI 33-40
PUMP L03 FEEDBACK LOOPS

CITY DRAWING NUMBER: 1-01211-A0211-001-00-B
SHEET 11 OF 23

11



B.M. ELEV.	DESIGNED BY	BLM
	DRAWN BY	MS
	CHECKED BY	BLM
	APPROVED BY	
	HOR. SCALE	NONE
	VERTICAL	
1 ISSUED FOR BID OP. 803-2016	SEP 14/16	BLM
NO. REVISIONS	DATE	BY

RELEASED FOR CONSTRUCTION

 DATE

ENGINEER'S SEAL

 CONSULTANT PROJECT NO. 163523

BURROWS AVE. LIFT STATION - RTU PANEL

 DI 41-48

 BACKUP POWER STATUS

 CITY DRAWING NUMBER: 1-01211-A0212-001-00-B

 SHEET 12 OF 23

 12



B.M. ELEV.	DESIGNED BY	BLM
	DRAWN BY	MS
	CHECKED BY	BLM
	APPROVED BY	
	HOR. SCALE	NONE
	VERTICAL	
1 ISSUED FOR BID OP. 803-2016	SEP 14/16	BLM
NO. REVISIONS	DATE	BY DATE

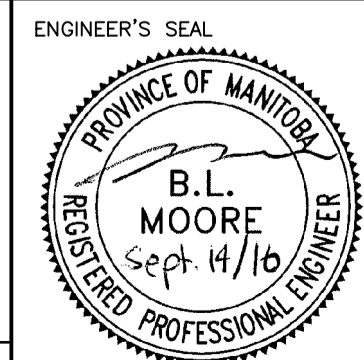

THE CITY OF WINNIPEG
WATER AND WASTE DEPARTMENT

BURROWS AVE. LIFT STATION - RTU PANEL

DI 33-40
DRY CONTACTS (DI 33-40 INTERNAL)
SPARE DRY CONTACTS

CITY DRAWING NUMBER
1-0121L-A0213-001-00-B

SHEET 13 OF 23

CONSULTANT PROJECT NO.
163523

13



B.M. ELEV.	DESIGNED BY	BLM
	DRAWN BY	MS
	CHECKED BY	BLM
	APPROVED BY	
	HOR. SCALE	NONE
	VERTICAL	
1 ISSUED FOR BID OP. 803-2016	SEP 14/16	BLM
NO. REVISIONS	DATE	BY DATE

DILLON CONSULTING

RELEASED FOR CONSTRUCTION

DATE

ENGINEER'S SEAL

PROVINCE OF MANITOBA

B.L. MOORE

Sept. 14/16

REGISTERED PROFESSIONAL ENGINEER

CONSULTANT PROJECT NO. 163523

THE CITY OF WINNIPEG
WATER AND WASTE DEPARTMENT

BURROWS AVE. LIFT STATION - RTU PANEL

HIGH SPEED COUNTER INPUTS

CITY DRAWING NUMBER: 1-01211-A0214-001-00-B

SHEET 14 OF 23

14

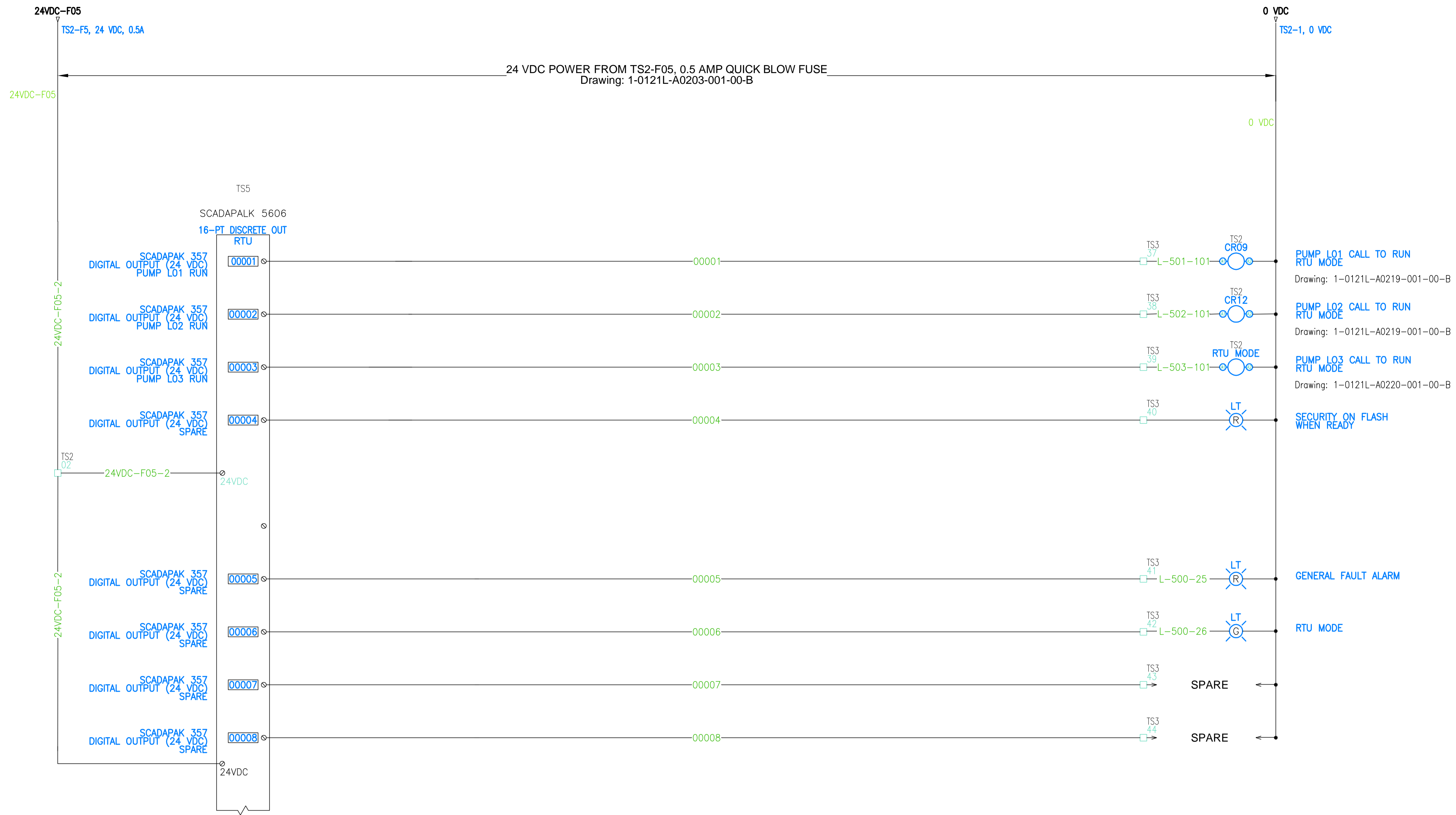

B.M. ELEV.	DESIGNED BY	BLM
	DRAWN BY	MS
	CHECKED BY	BLM
	APPROVED BY	
	HOR. SCALE	NONE
	VERTICAL	
1 ISSUED FOR BID OP. 803-2016	SEP 14/16	BLM
NO. REVISIONS	DATE	BY DATE

DILLON CONSULTING

RELEASED FOR CONSTRUCTION

DATE

ENGINEER'S SEAL

PROVINCE OF MANITOBA

B.L. MOORE
Sept. 14/16
REGISTERED PROFESSIONAL ENGINEER

CONSULTANT PROJECT NO.
163523

THE CITY OF WINNIPEG
WATER AND WASTE DEPARTMENT

BURROWS AVE. LIFT STATION - RTU PANEL

DO 01-08
PUMP RTU MODE CALL TO RUNS

CITY DRAWING NUMBER
1-0121L-A0215-001-00-B

SHEET 15 OF 23

15



B.M. ELEV.	DESIGNED BY	BLM
	DRAWN BY	MS
	CHECKED BY	BLM
	APPROVED BY	
	HOR. SCALE	NONE
	VERTICAL	
1 ISSUED FOR BID OP. 803-2016	SEP 14/16	BLM
NO. REVISIONS	DATE	BY DATE

DILLON CONSULTING

RELEASED FOR CONSTRUCTION

DATE

ENGINEER'S SEAL

PROVINCE OF MANITOBA

B.L. MOORE

Sept. 14/16

REGISTERED PROFESSIONAL ENGINEER

CONSULTANT PROJECT NO. 163523

THE CITY OF WINNIPEG
WATER AND WASTE DEPARTMENT

BURROWS AVE. LIFT STATION - RTU PANEL

DO 09-16
RTU MODE, LOCAL MODE,
FAIL TO LOCAL

CITY DRAWING NUMBER 1-0121L-A0216-001-00-B
SHEET 16 OF 23

16

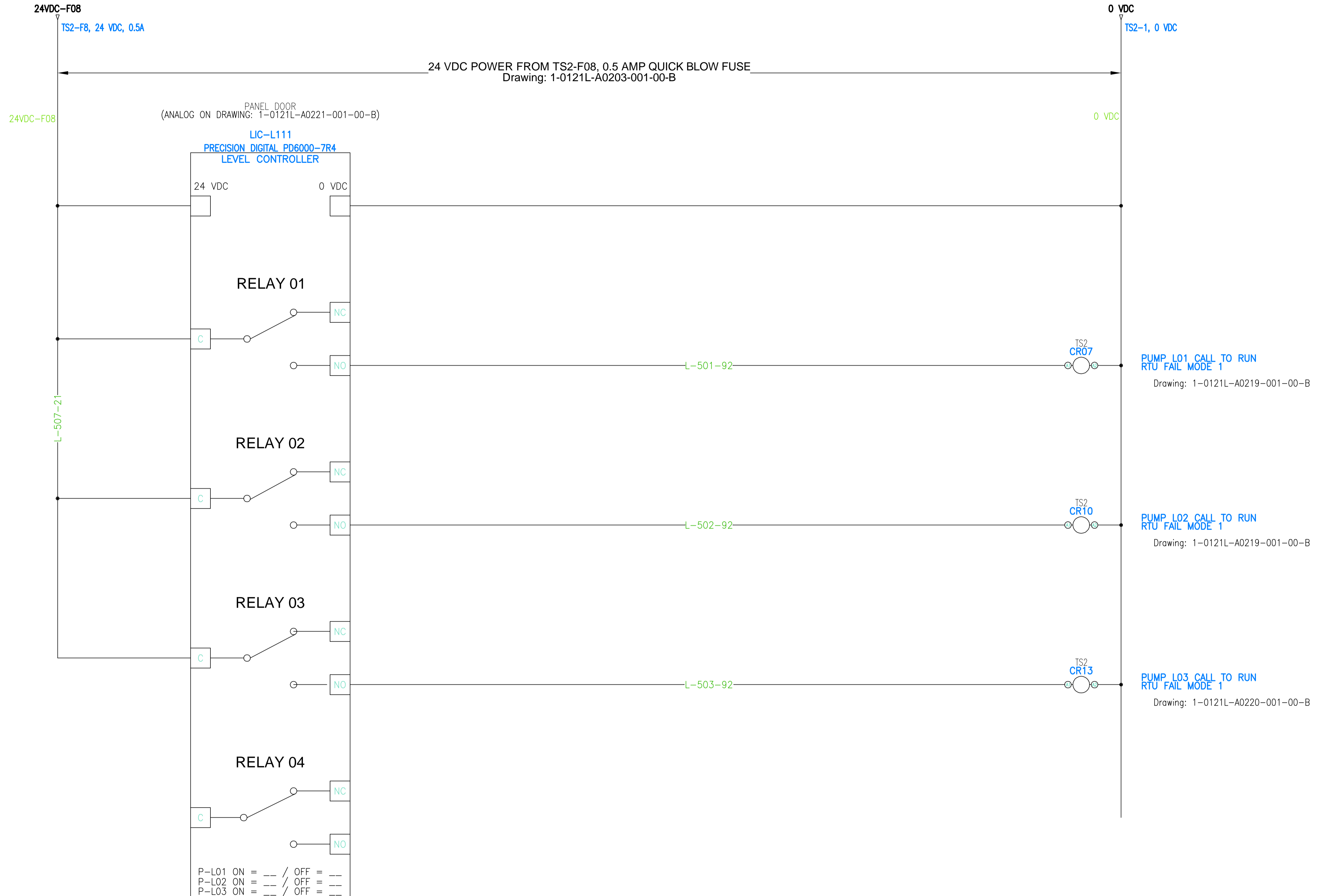

B.M. ELEV.	DESIGNED BY	BLM
	DRAWN BY	MS
	CHECKED BY	BLM
	APPROVED BY	
	HOR. SCALE	NONE
	VERTICAL	
1 ISSUED FOR BID OP. 803-2016	SEP 14/16	BLM
NO. REVISIONS	DATE	BY

DILLON CONSULTING

RELEASED FOR CONSTRUCTION

DATE

ENGINEER'S SEAL

PROVINCE OF MANITOBA

B.L. MOORE

Sept. 14/16

REGISTERED PROFESSIONAL ENGINEER

CONSULTANT PROJECT NO. 163523

THE CITY OF WINNIPEG
WATER AND WASTE DEPARTMENT

BURROWS AVE. LIFT STATION - RTU PANEL

LIC-L111 LOCAL LEVEL PUMP RUNS
PRECISION DIGITAL (PD6000)

CITY DRAWING NUMBER: 1-0121L-A0217-001-00-B

SHEET 17 OF 23

17

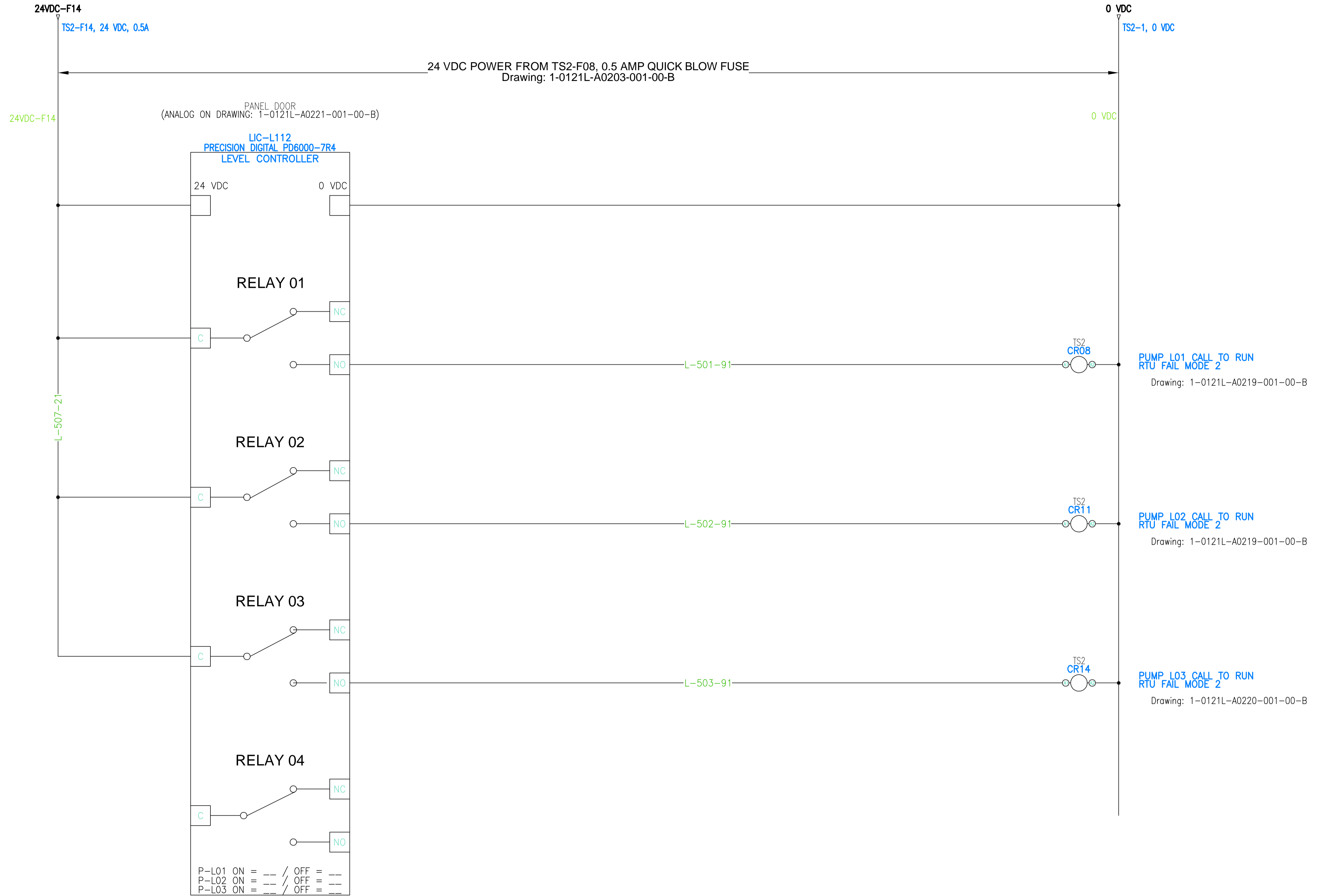

B.M. ELEV.	DESIGNED BY	BLM
	DRAWN BY	MS
	CHECKED BY	BLM
	APPROVED BY	
	HOR. SCALE	NONE
	VERTICAL	
1 ISSUED FOR BID OP. 803-2016	SEP 14/16	BLM
NO. REVISIONS	DATE	BY

DILLON CONSULTING

RELEASED FOR CONSTRUCTION

DATE

ENGINEER'S SEAL

PROVINCE OF MANITOBA

B.L. MOORE

Sept. 14/16

REGISTERED PROFESSIONAL ENGINEER

CONSULTANT PROJECT NO. 163523

THE CITY OF WINNIPEG
WATER AND WASTE DEPARTMENT

BURROWS AVE. LIFT STATION - RTU PANEL

LIC-L112 LOCAL LEVEL PUMP RUNS
PRECISION DIGITAL (PD6000)

CITY DRAWING NUMBER: 1-0121L-A0218-001-00-B

SHEET 18 OF 23

18



B.M. ELEV.		DESIGNED BY BLM				BURROWS AVE. LIFT STATION - RTU PANEL PUMP RUNS CONTACTS PUMP L01 & L02 RUNS	CITY DRAWING NUMBER 1-0121L-A0219-001-00-B
		DRAWN BY MS					SHEET OF 19 OF 23
		CHECKED BY BLM					
		APPROVED BY					
		HOR. SCALE NONE	RELEASED FOR CONSTRUCTION	CONSULTANT PROJECT NO. 163523			
NO. REVISIONS		DATE	BY	DATE			

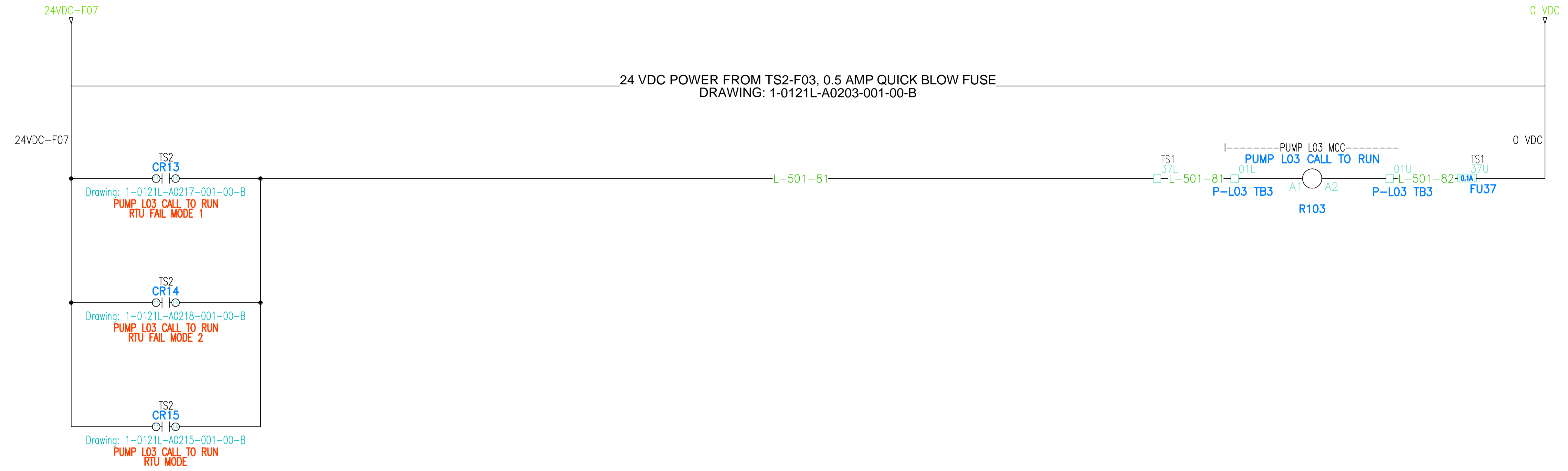

B.M. ELEV.	DESIGNED BY	BLM
	DRAWN BY	MS
	CHECKED BY	BLM
	APPROVED BY	
	HOR. SCALE	NONE
	VERTICAL	
1	ISSUED FOR BID OP. 803-2016	SEP 14/16 BLM
NO.	REVISIONS	DATE BY DATE

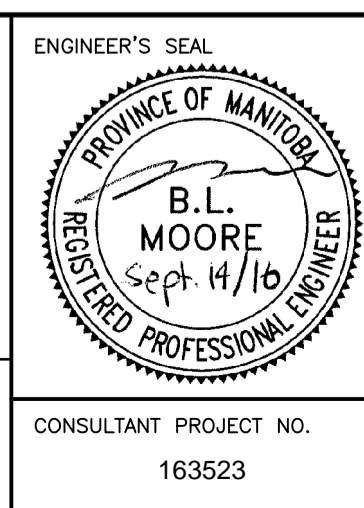
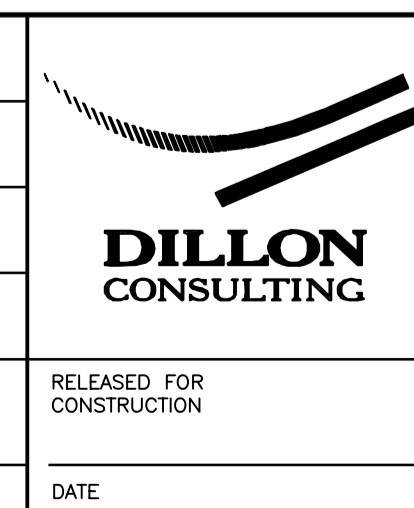

THE CITY OF WINNIPEG
WATER AND WASTE DEPARTMENT

BURROWS AVE. LIFT STATION - RTU PANEL

PUMP RUNS CONTACTS
PUMP L03 RUNS

CITY DRAWING NUMBER
1-0121L-A0220-001-00-B

SHEET 20 OF 23

CONSULTANT PROJECT NO.
163523

20

PANEL DOOR
DIGITAL ON DRAWING (1-0121L-A0217-001-00-B)

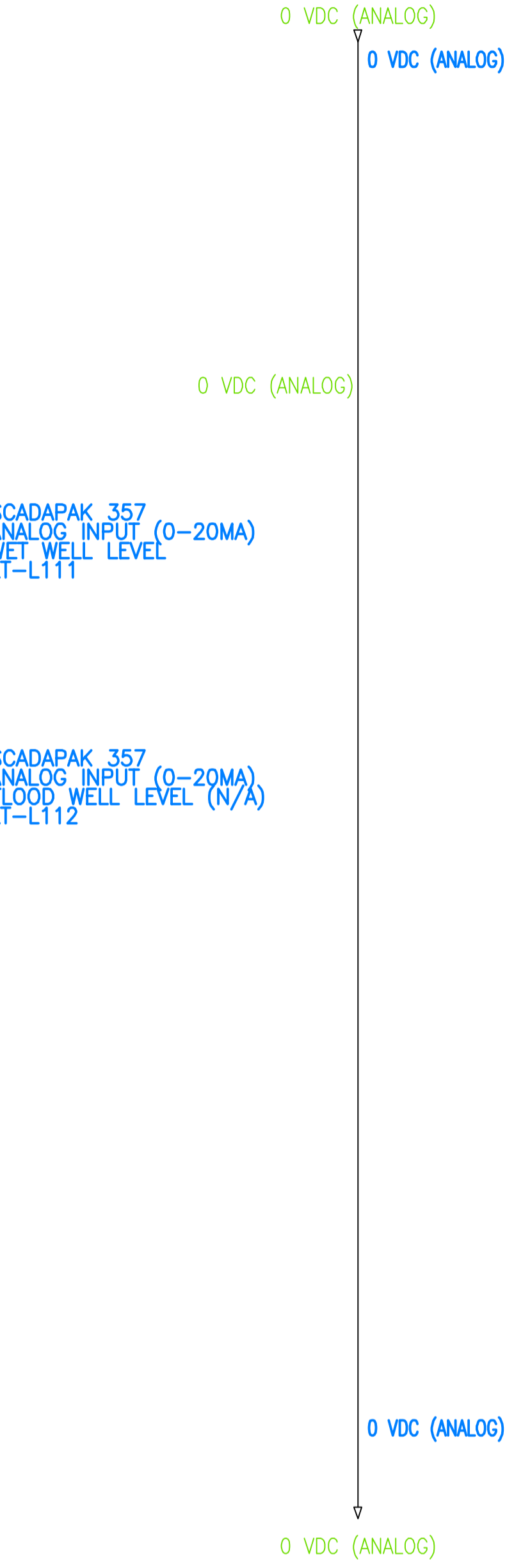
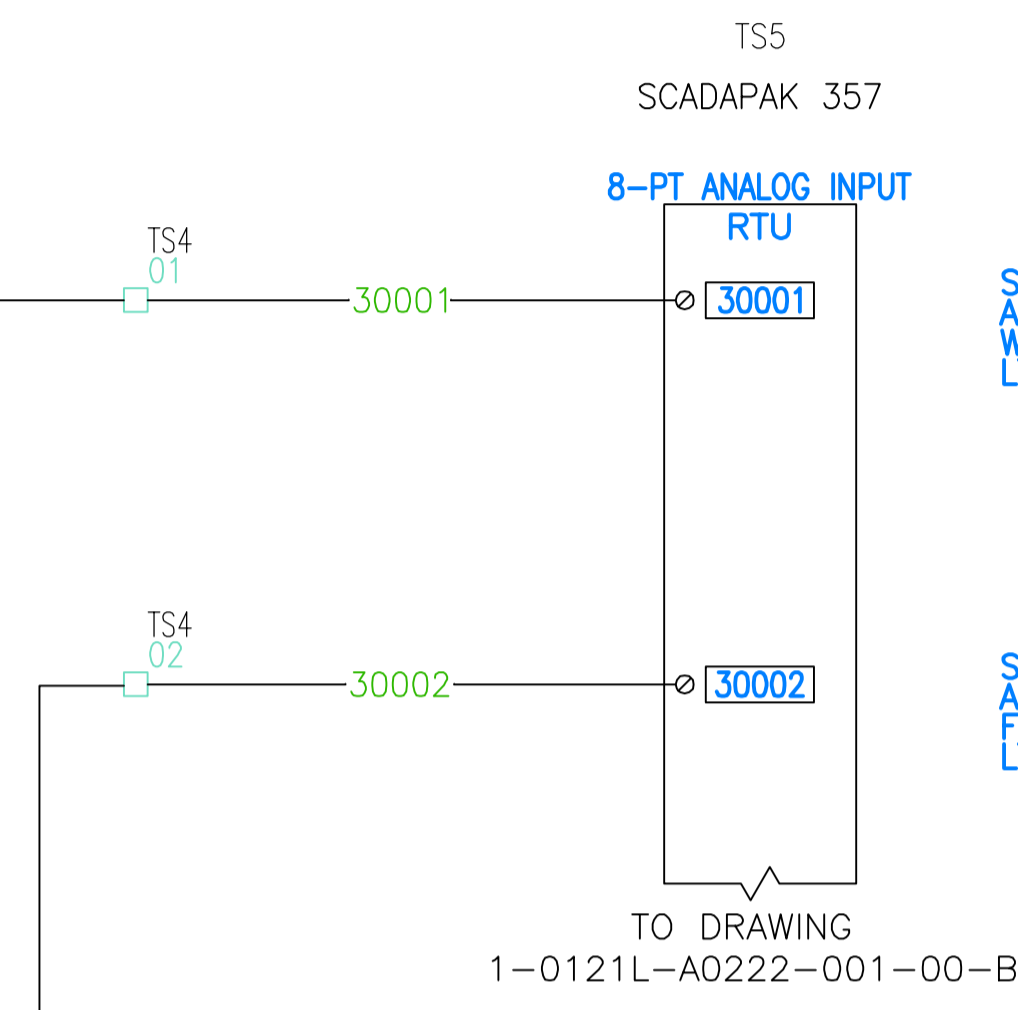
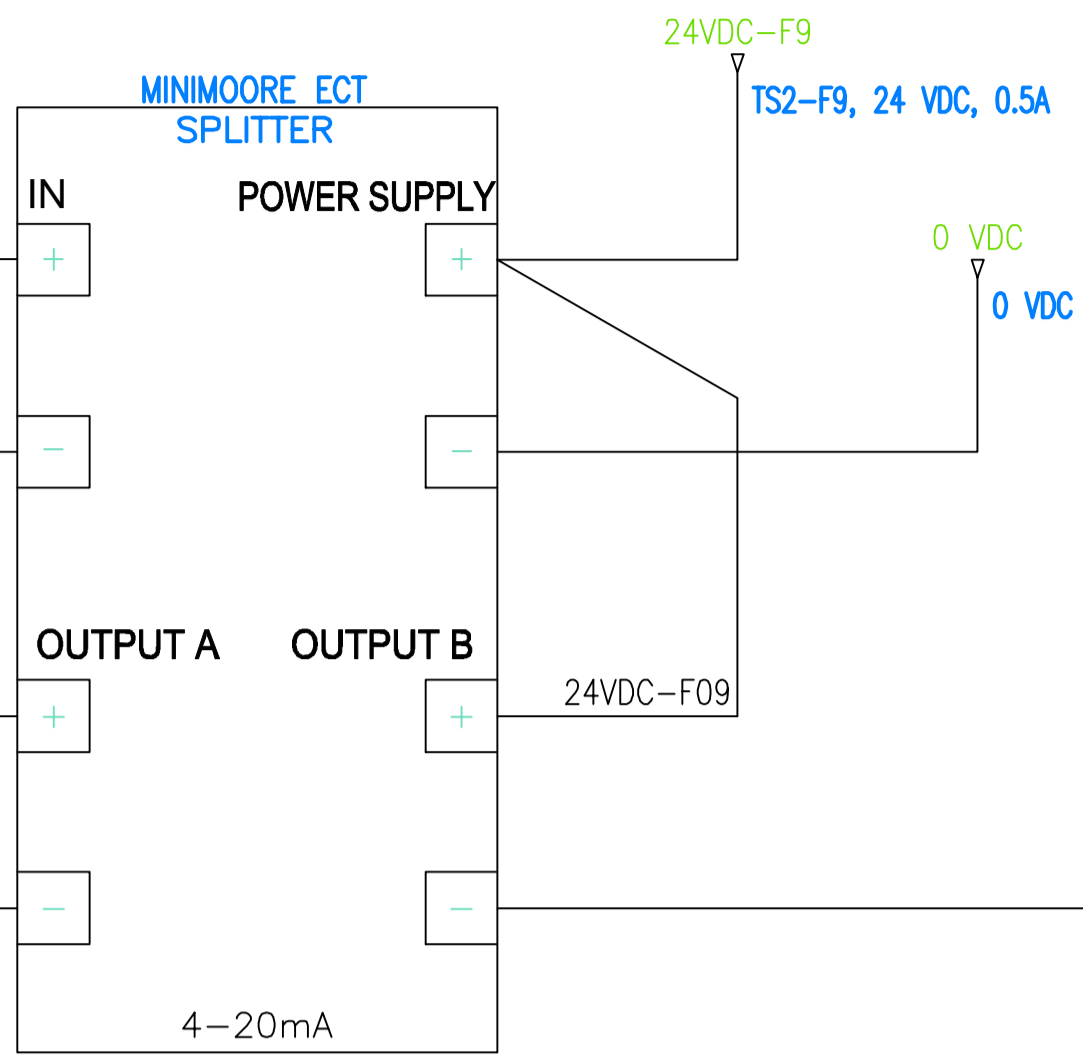
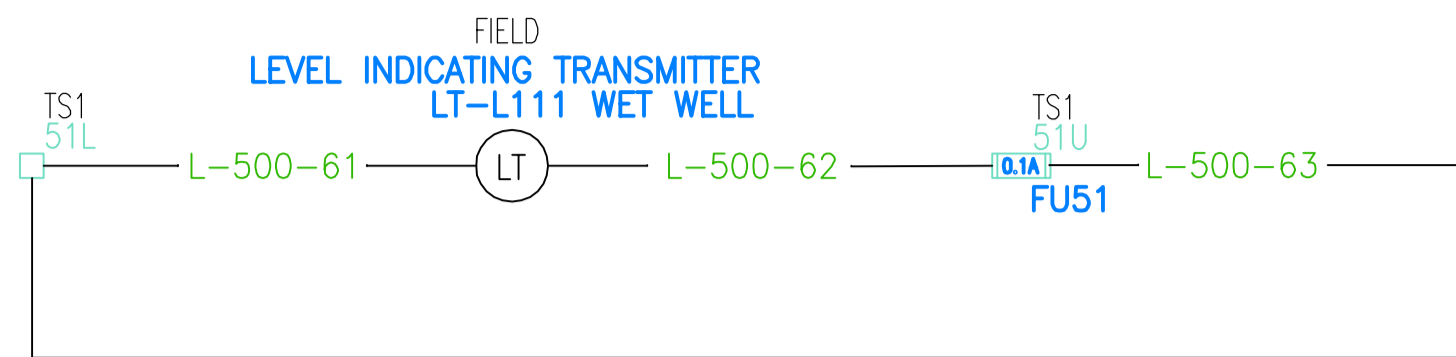
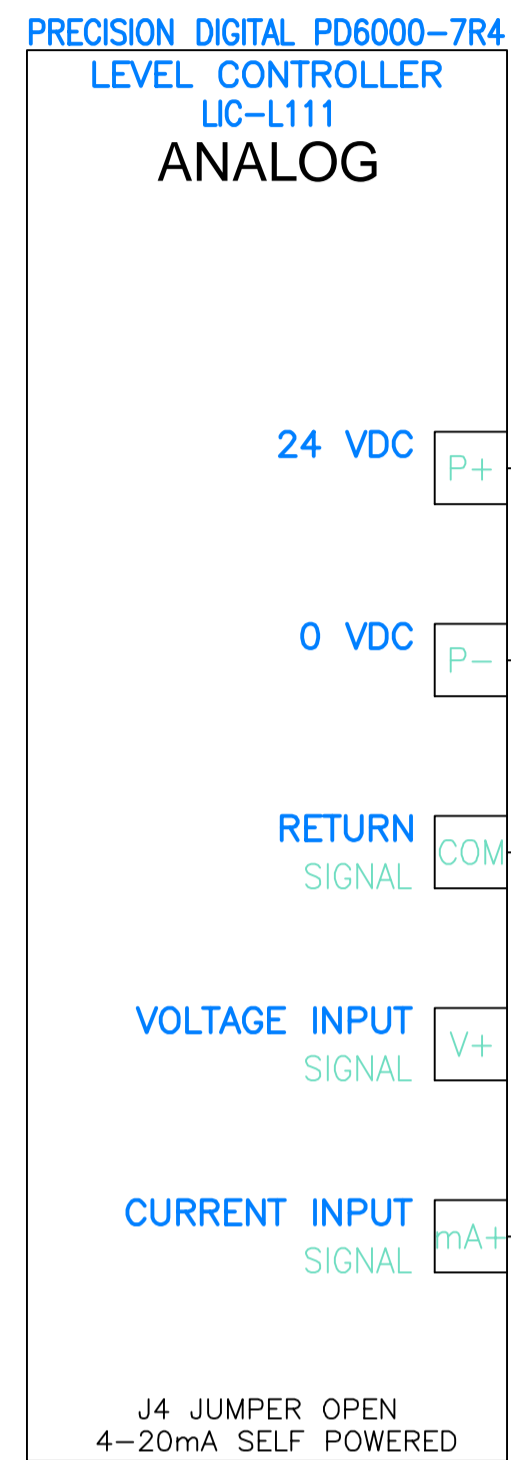

PANEL DOOR
DIGITAL ON DRAWING (1-0121L-A0218-001-00-B)

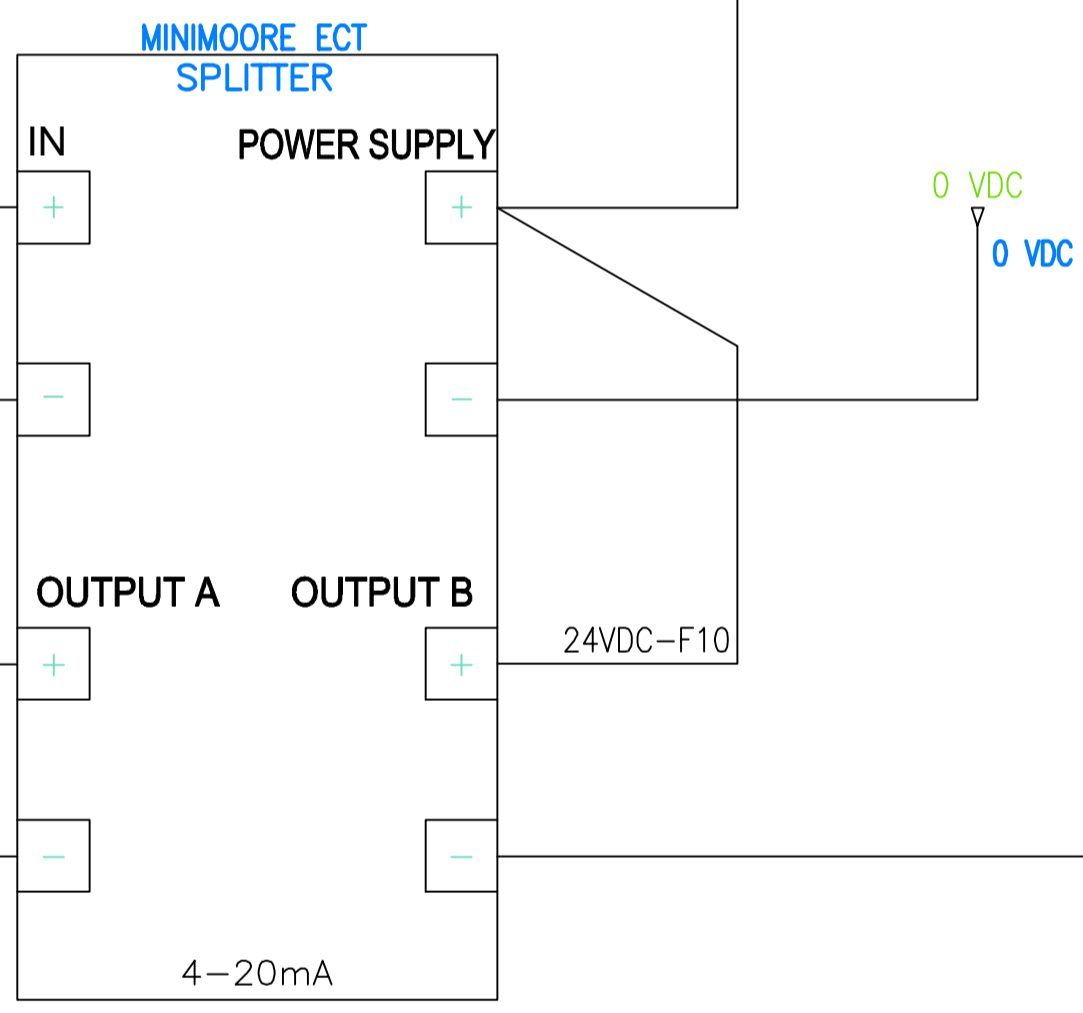
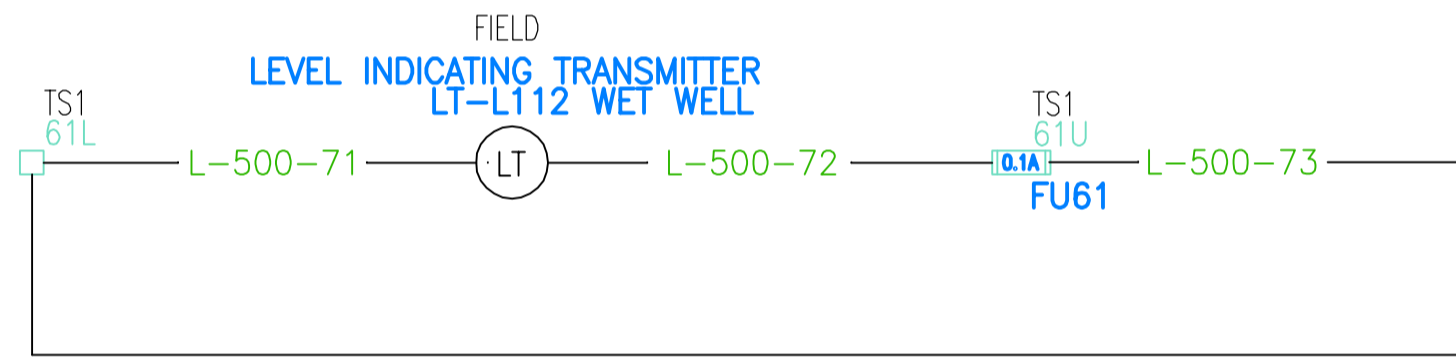
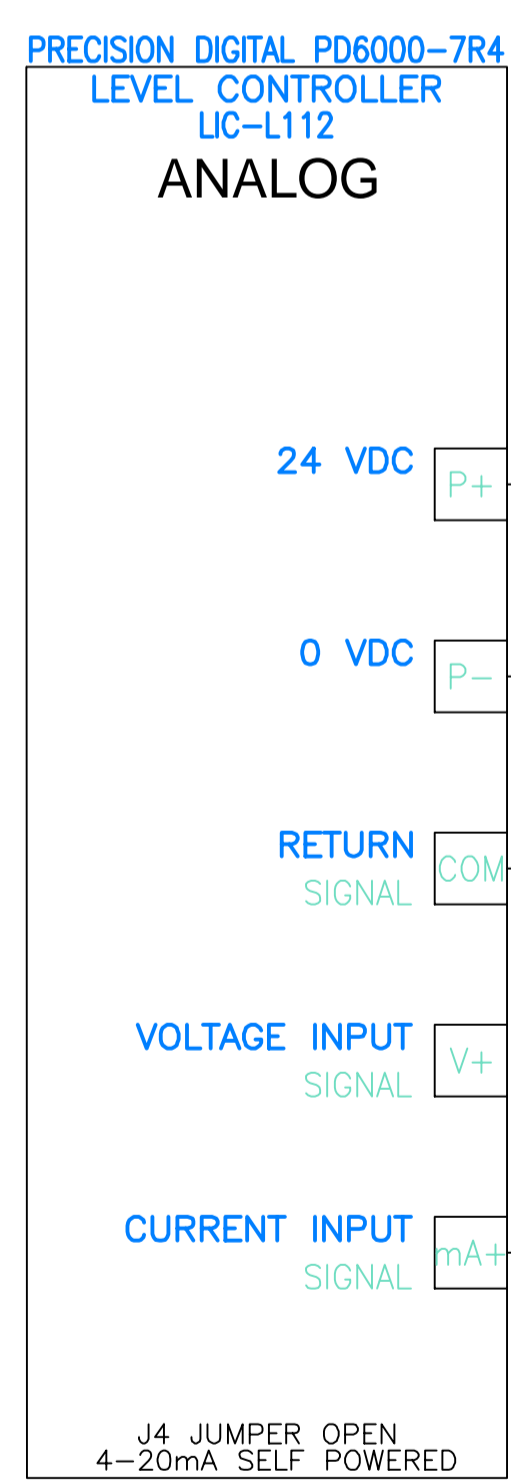

B.M. ELEV.	DESIGNED BY	BLM
	DRAWN BY	MS
	CHECKED BY	BLM
	APPROVED BY	
	HOR. SCALE	NONE
	VERTICAL	
1 ISSUED FOR BID OP. 803-2016	SEP 14/16	BLM
NO. REVISIONS	DATE	BY DATE

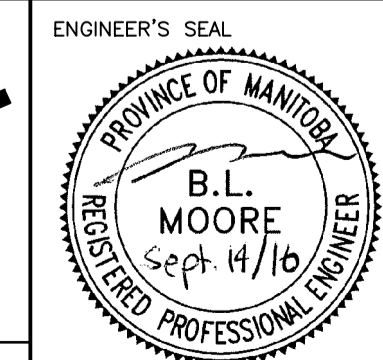

THE CITY OF WINNIPEG
WATER AND WASTE DEPARTMENT

BURROWS AVE. LIFT STATION - RTU PANEL

AI 01-02
LEVEL FEEDBACK

CITY DRAWING NUMBER
1-0121L-A0221-001-00-B

SHEET 21 OF 23

CONSULTANT PROJECT NO.
163523

21

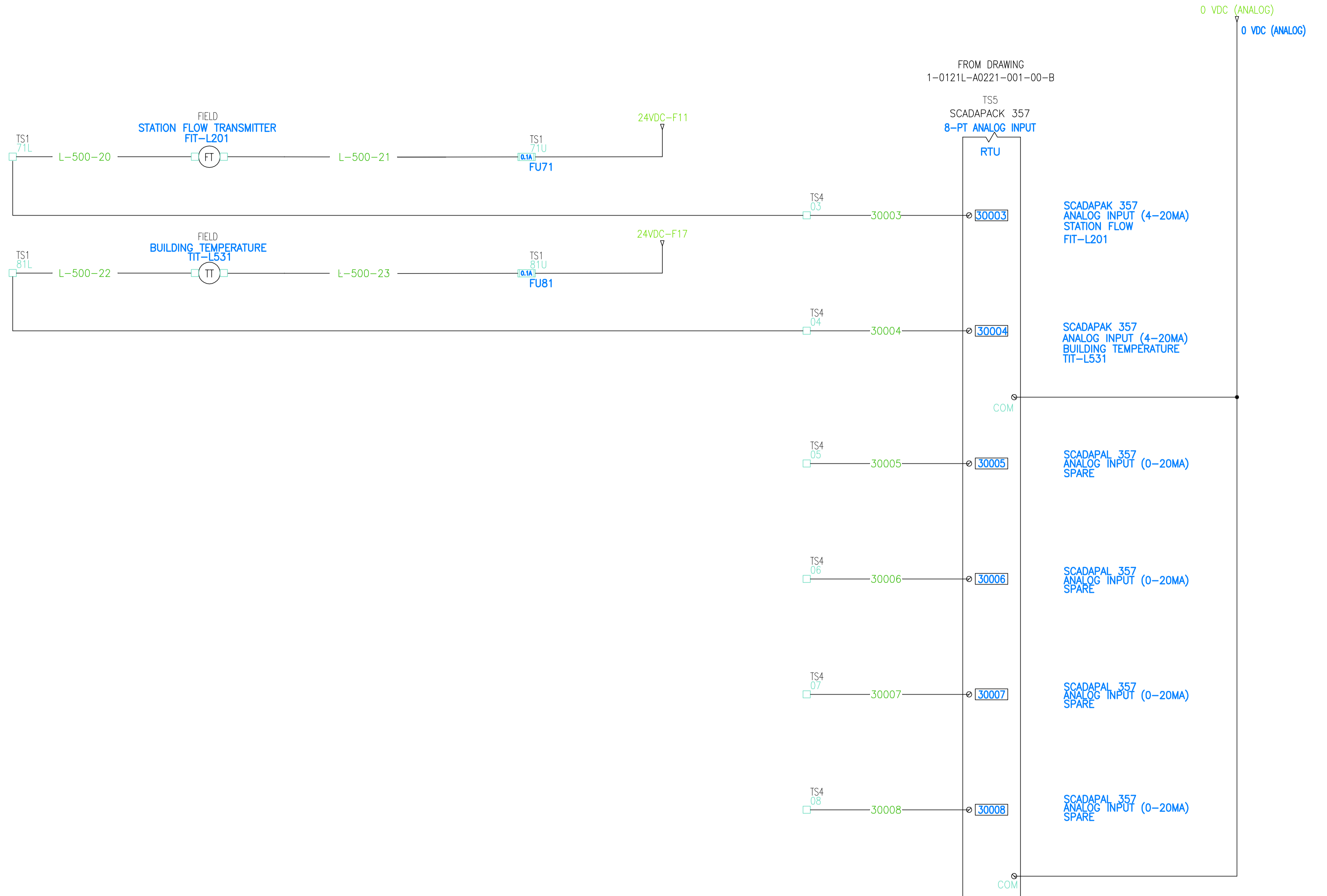



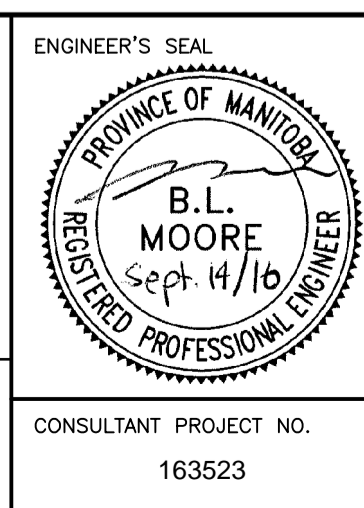
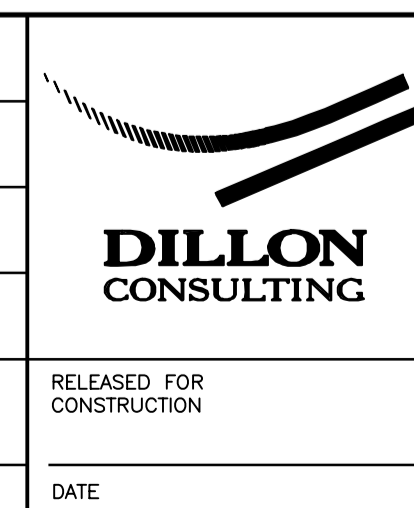

B.M. ELEV.	DESIGNED BY	BLM
	DRAWN BY	MS
	CHECKED BY	BLM
	APPROVED BY	
	HOR. SCALE	NONE
	VERTICAL	
1 ISSUED FOR BID OP. 803-2016	SEP 14/16	BLM
NO. REVISIONS	DATE	BY DATE

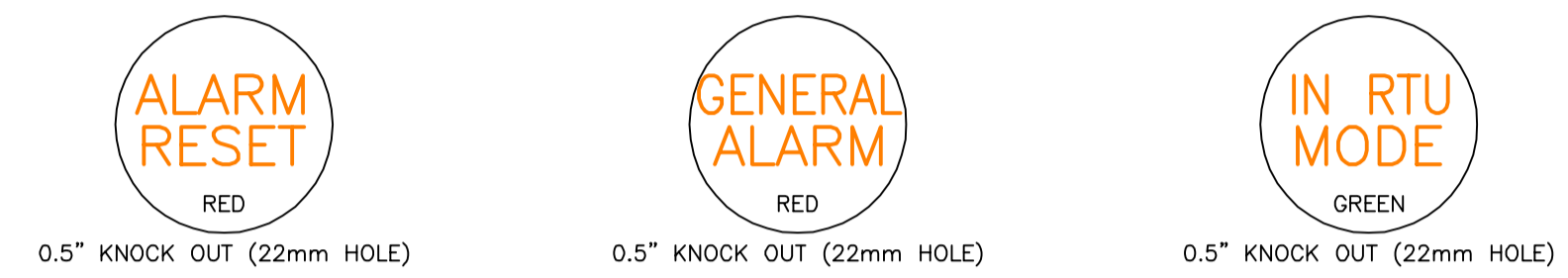
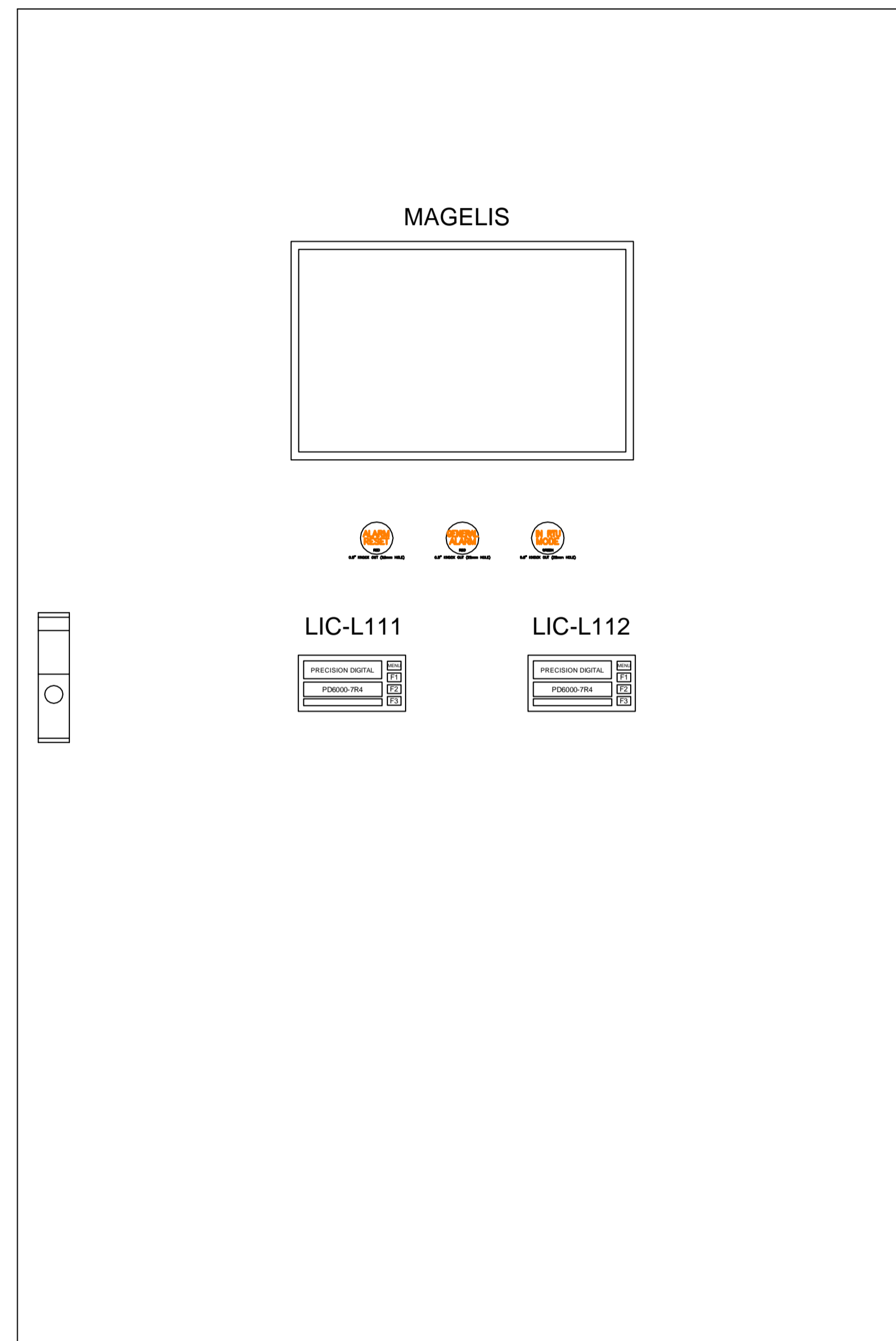

THE CITY OF WINNIPEG WATER AND WASTE DEPARTMENT	
BURROWS AVE. LIFT STATION - RTU PANEL	
AI 03-08 LEVEL FEEDBACK, SPARE	
CITY DRAWING NUMBER 1-0121L-A0222-001-00-B	SHEET OF 22 OF 23
CONSULTANT PROJECT NO. 163523	
22	

ALARM DISPLAY AND SWITCH BUTTON QUICK REFERENCE



B.M. ELEV.		DESIGNED BY BLM	 DILLON CONSULTING		 THE CITY OF WINNIPEG WATER AND WASTE DEPARTMENT	BURROWS AVE. LIFT STATION - RTU PANEL DOOR LAYOUT	CITY DRAWING NUMBER 1-01211-A0223-001-00-B
		DRAWN BY MS					SHEET 23 OF 23
		CHECKED BY BLM					
		APPROVED BY					
		HOR. SCALE NONE	RELEASED FOR CONSTRUCTION	CONSULTANT PROJECT NO. 163523			
		VERTICAL	DATE				
NO.	REVISIONS	DATE	BY	DATE			