

Eastbound Roblin, N/S Dieppe
Stop 60545 Dieppe

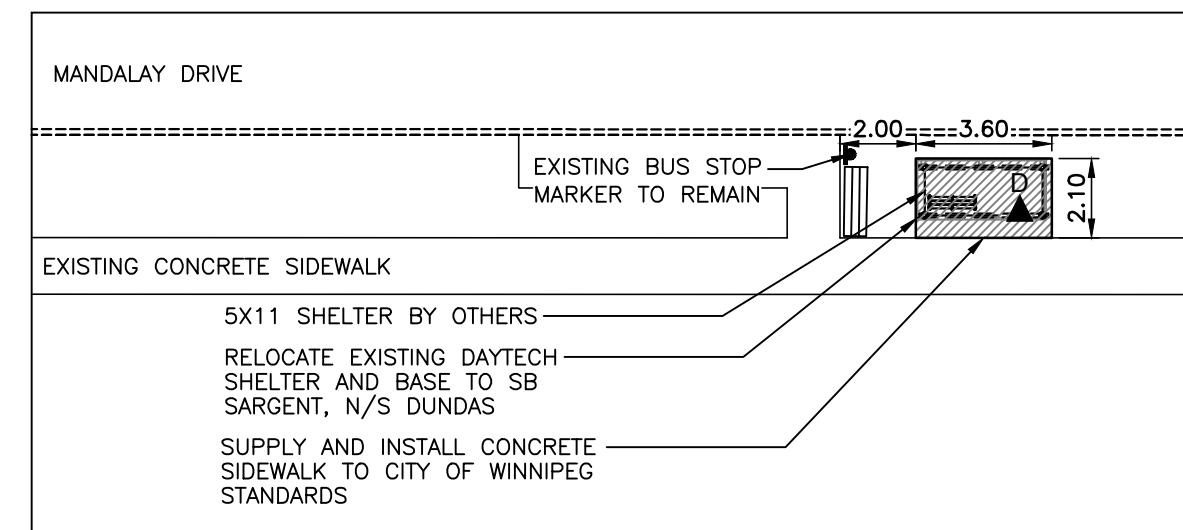

Northbound Mandalay, F/S Mapleton
Stop 30633 Mapleton

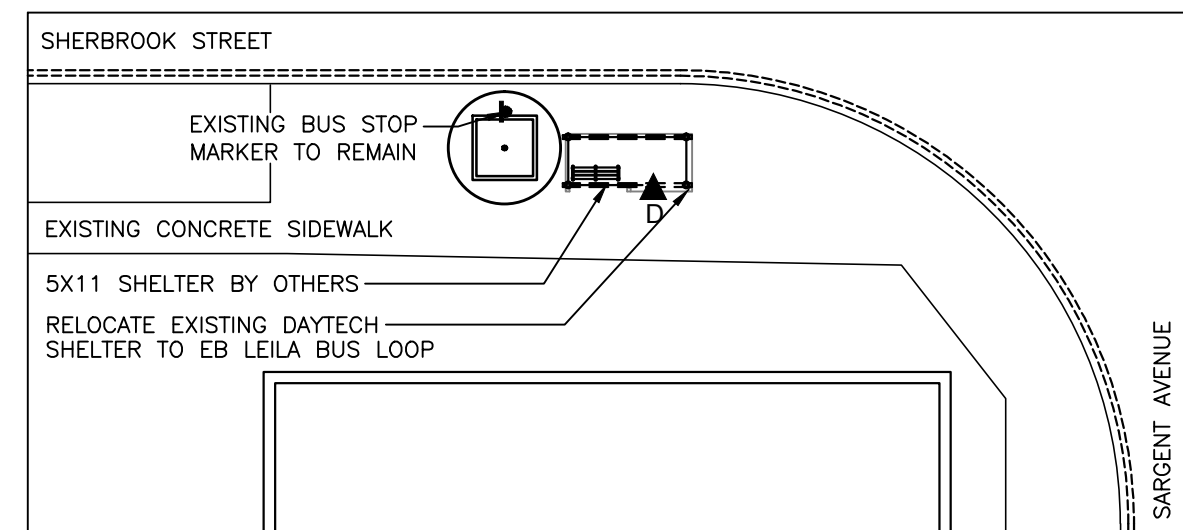

Northbound Sherbrook, N/S Sargent
Stop 10436 Sargent

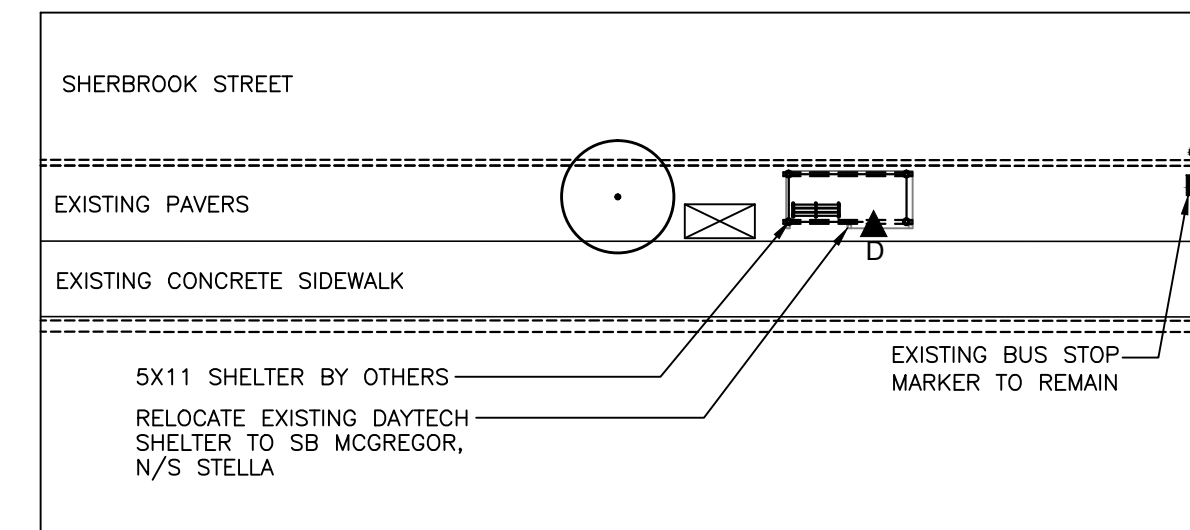

Northbound Sherbrook, N/S Wolseley
Stop 10206 Misericordia Health Centre

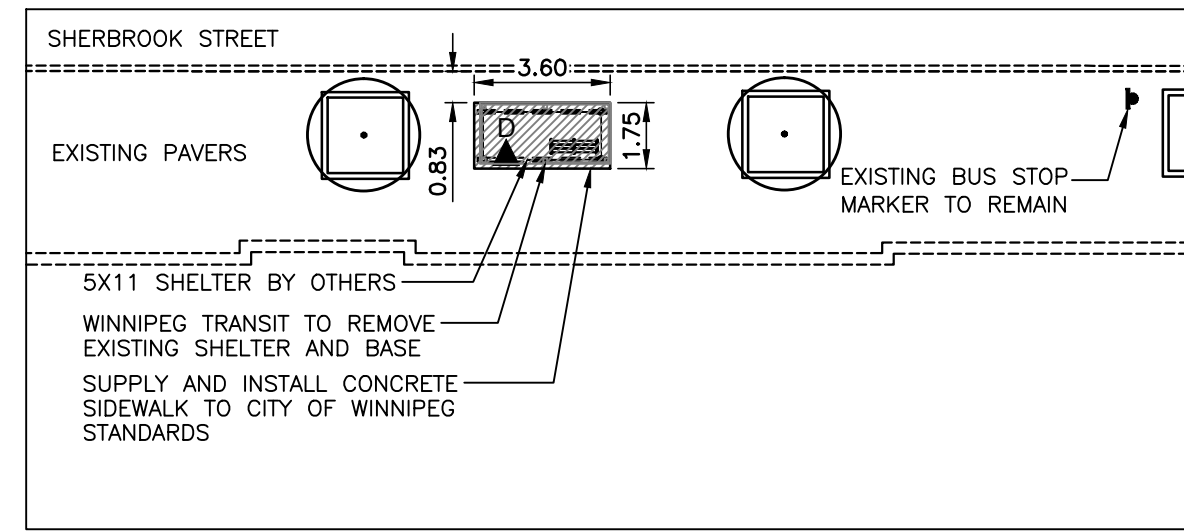

Northbound Sherbrook, N/S Ellice
Stop 10434 Ellice

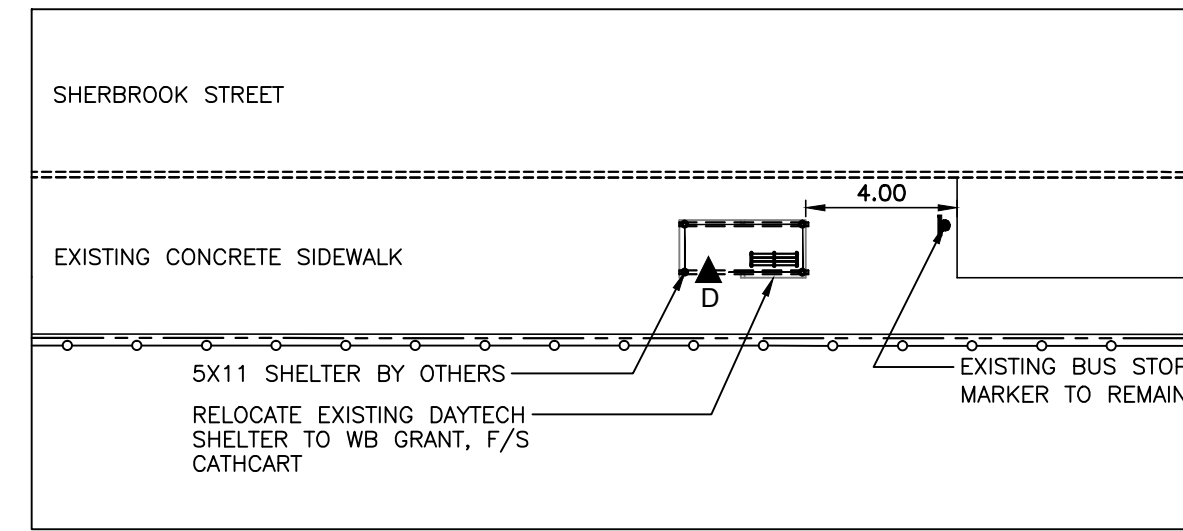

Northbound Sherbrook, F/S Broadway
Stop 10200 Broadway North

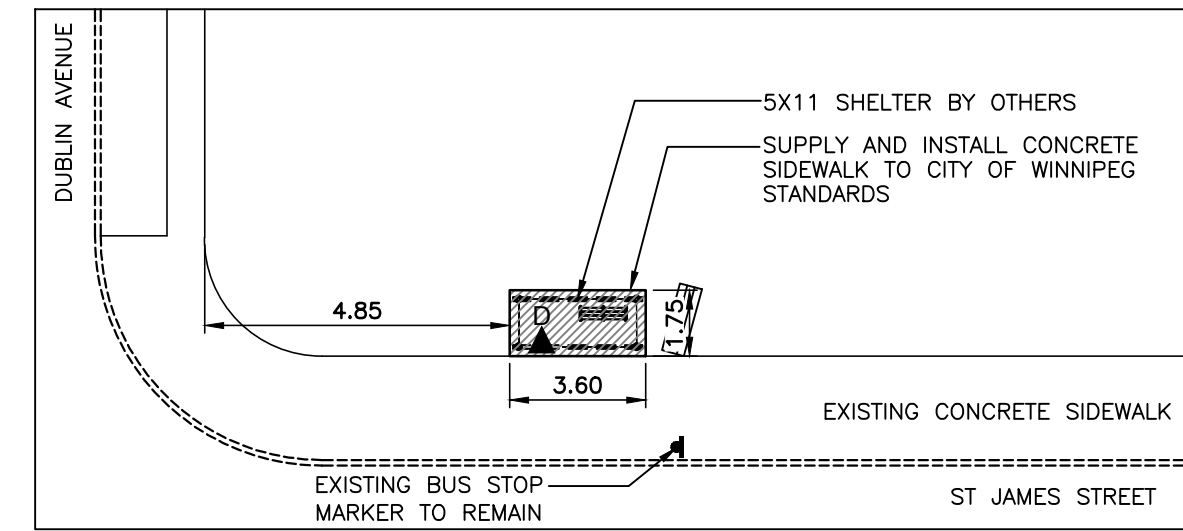

Southbound St James, N/S Dublin
Stop 20009 Dublin

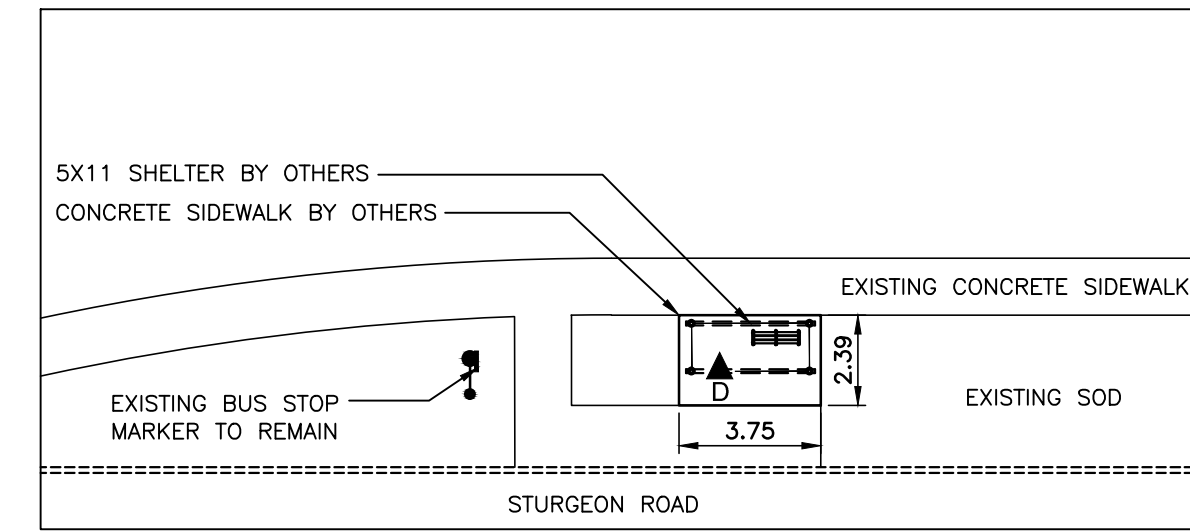

Southbound Sturgeon, N/S Portage
Stop 20296 Portage North

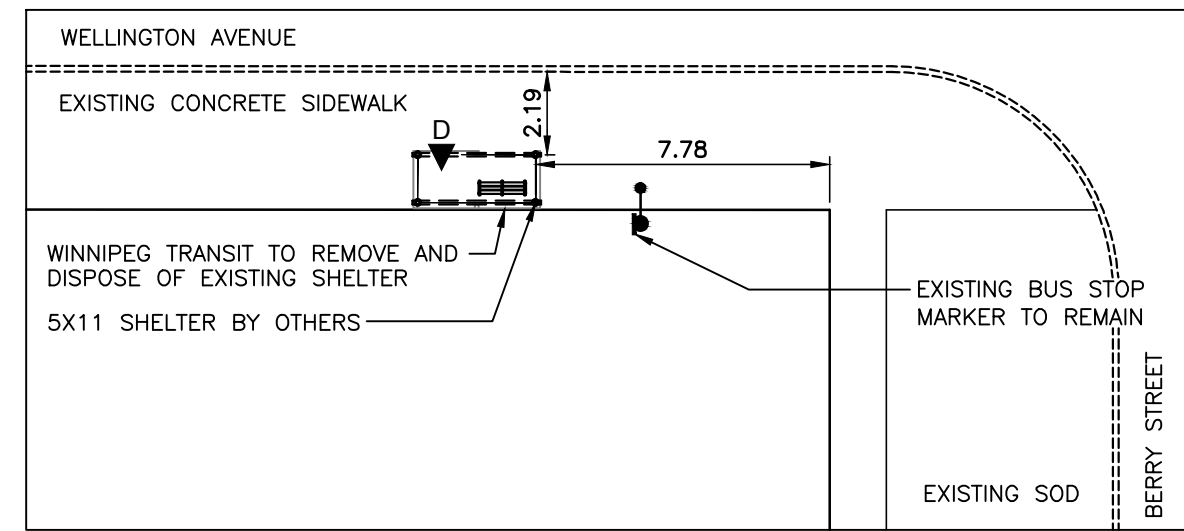

Eastbound Wellington, N/S Berry
Stop 20075 Berry

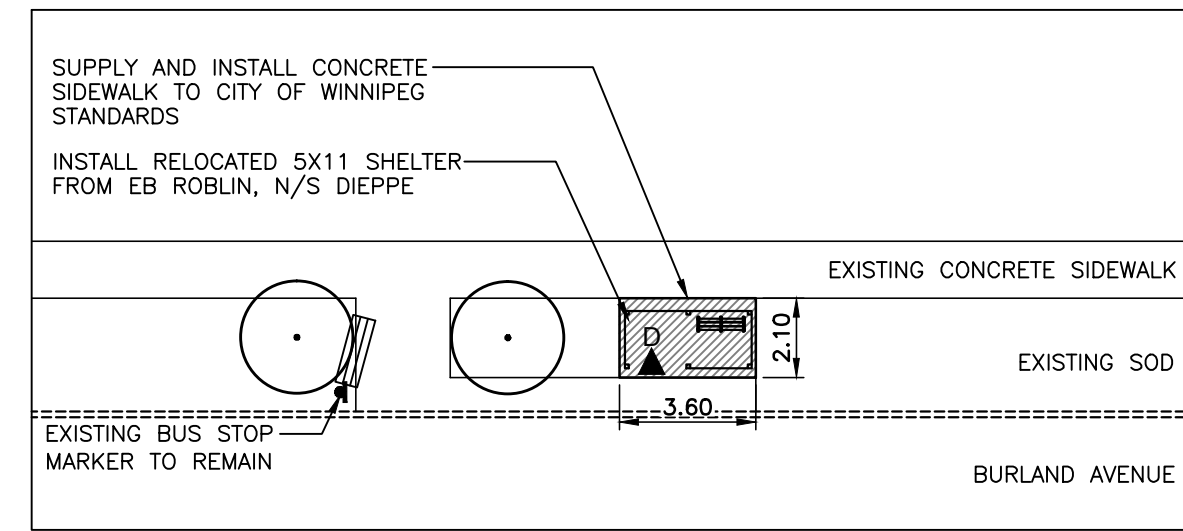

Westbound Burland, N/S St. Mary's
Stop 50684 St. Mary's

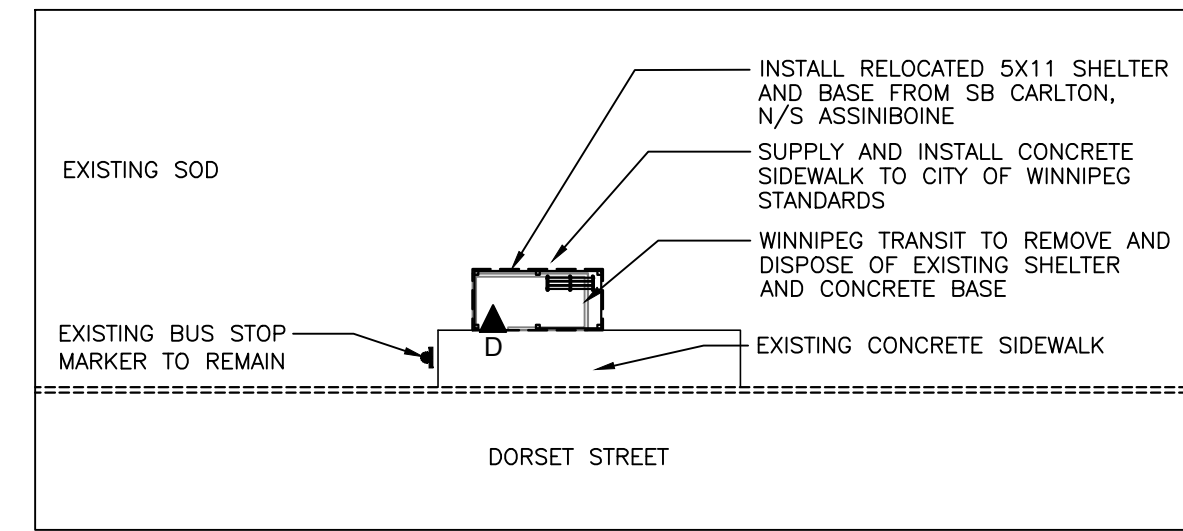

Southbound Dorset, F/S Burrows
Stop 30678 Burrows

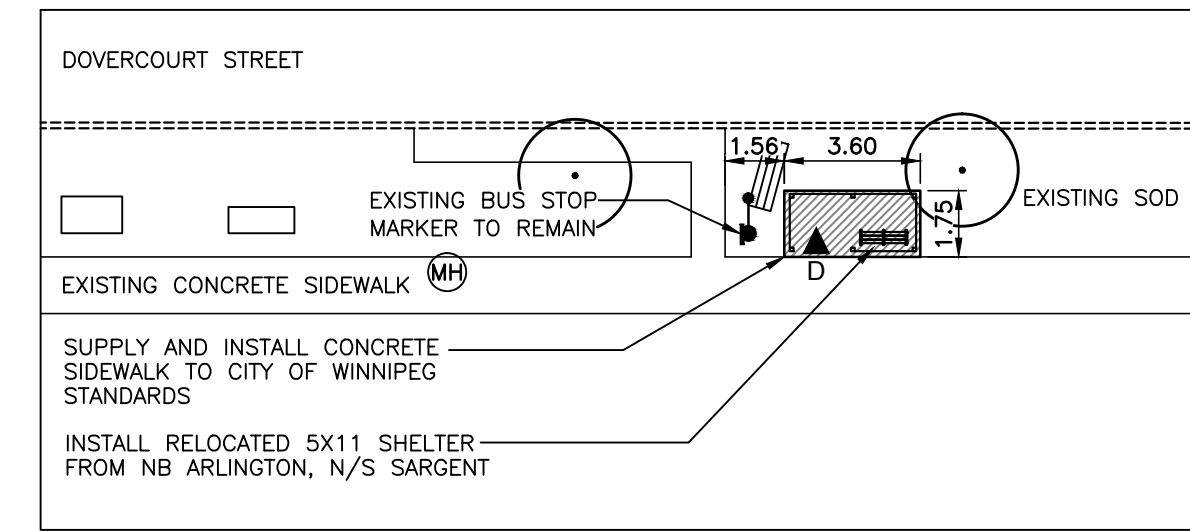

Northbound Dovercourt, F/S Falcon Ridge
Stop 61124 Falcon Ridge

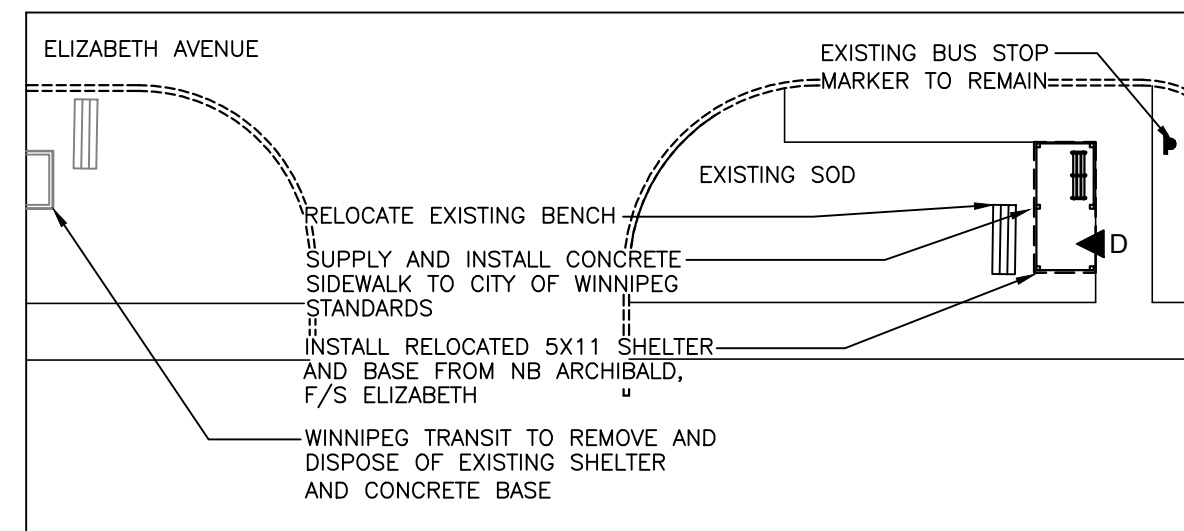

Eastbound Elizabeth, F/S Drake
Stop 50040 Drake

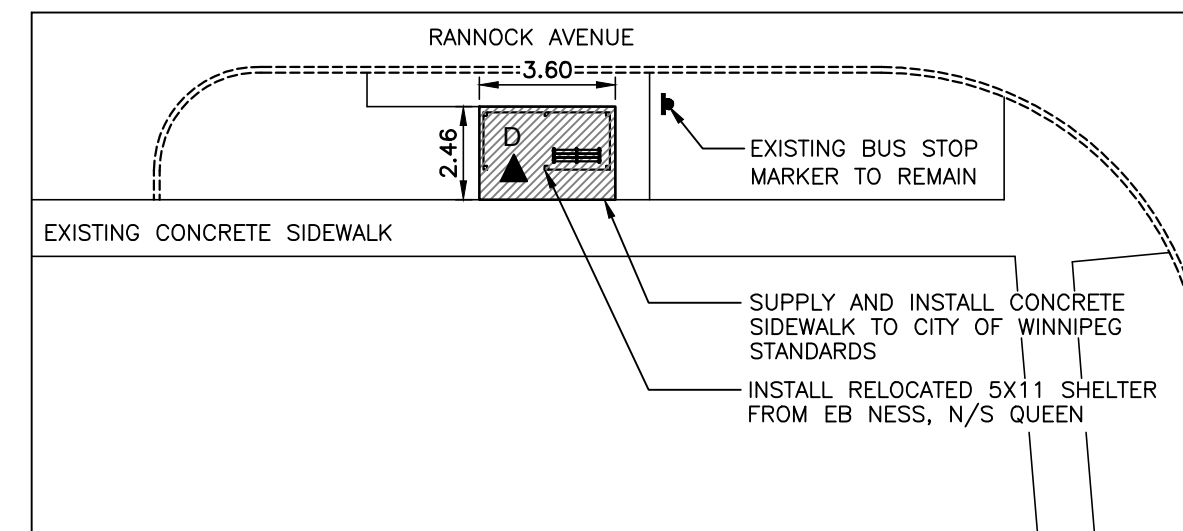

Eastbound Rannock, N/S Cullen
Stop 60596 Cullen

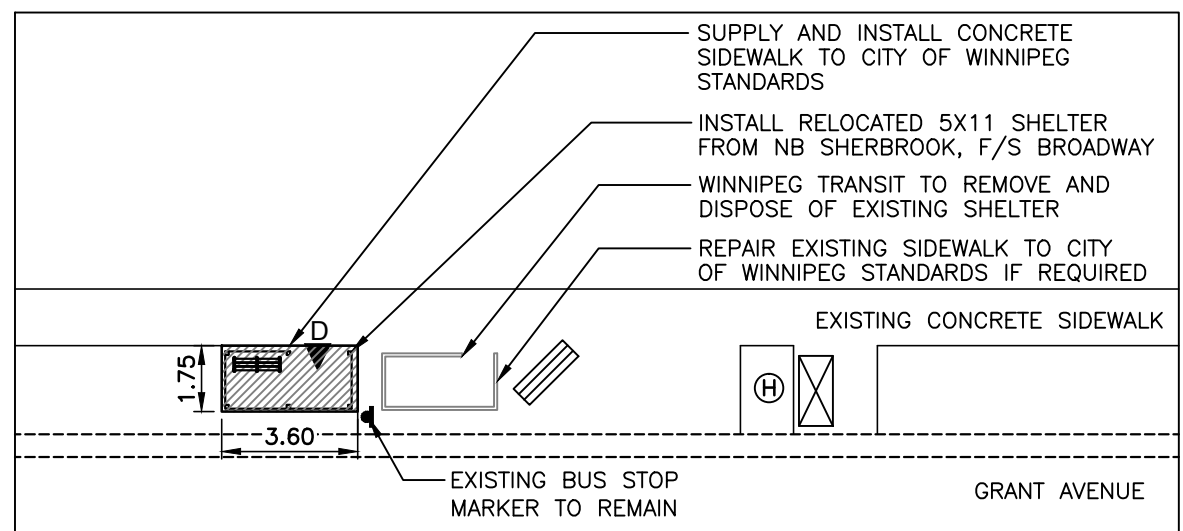

Westbound Grant, F/S Cathcart
Stop 60527 Cathcart

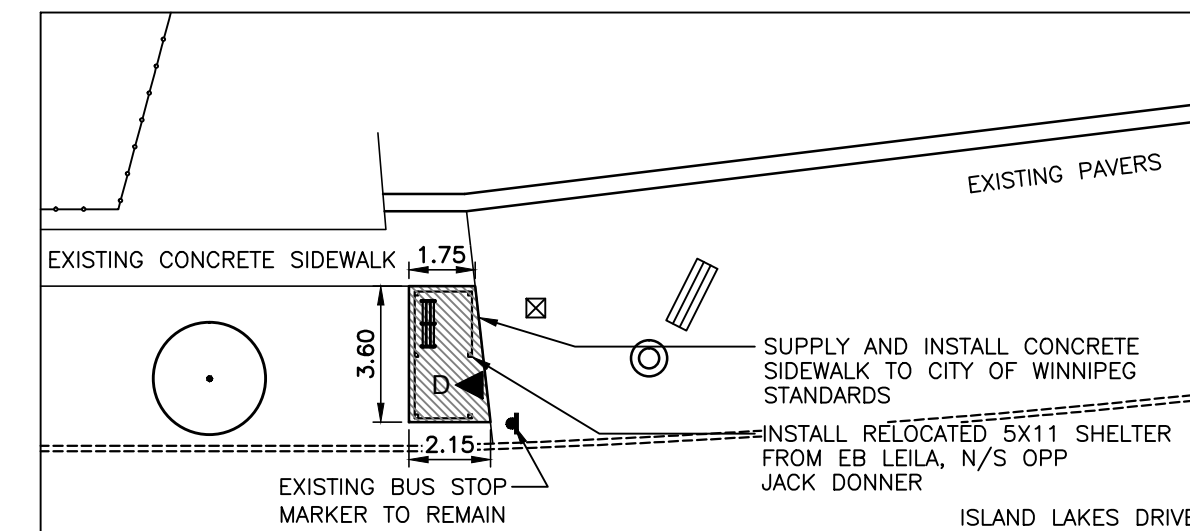

Westbound Island Lakes, F/S Opp Camirant
Stop 50596 Camirant West

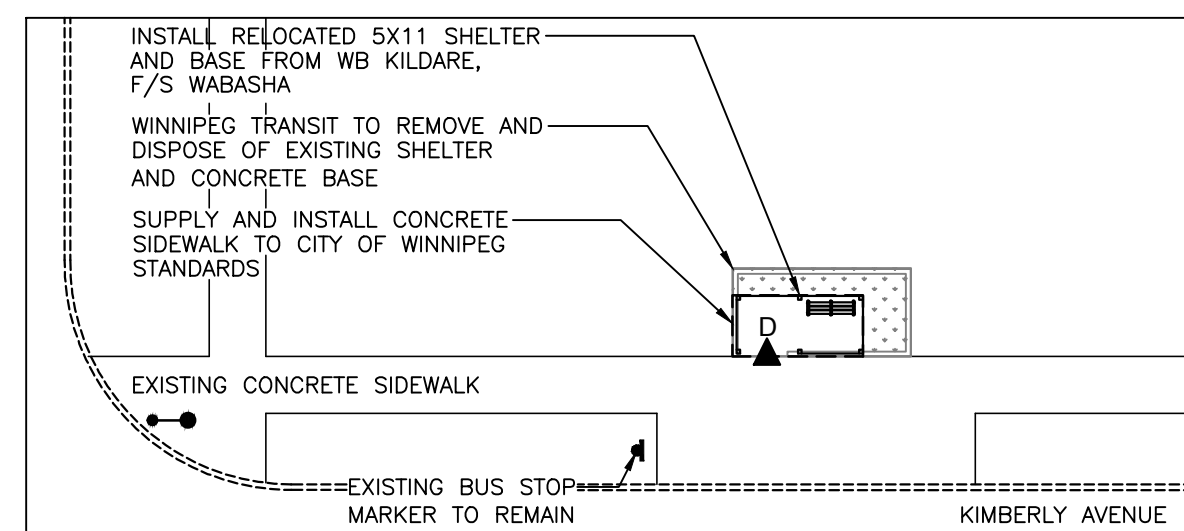

Westbound Kimberly, N/S Golspie
Stop 40510 Golspie

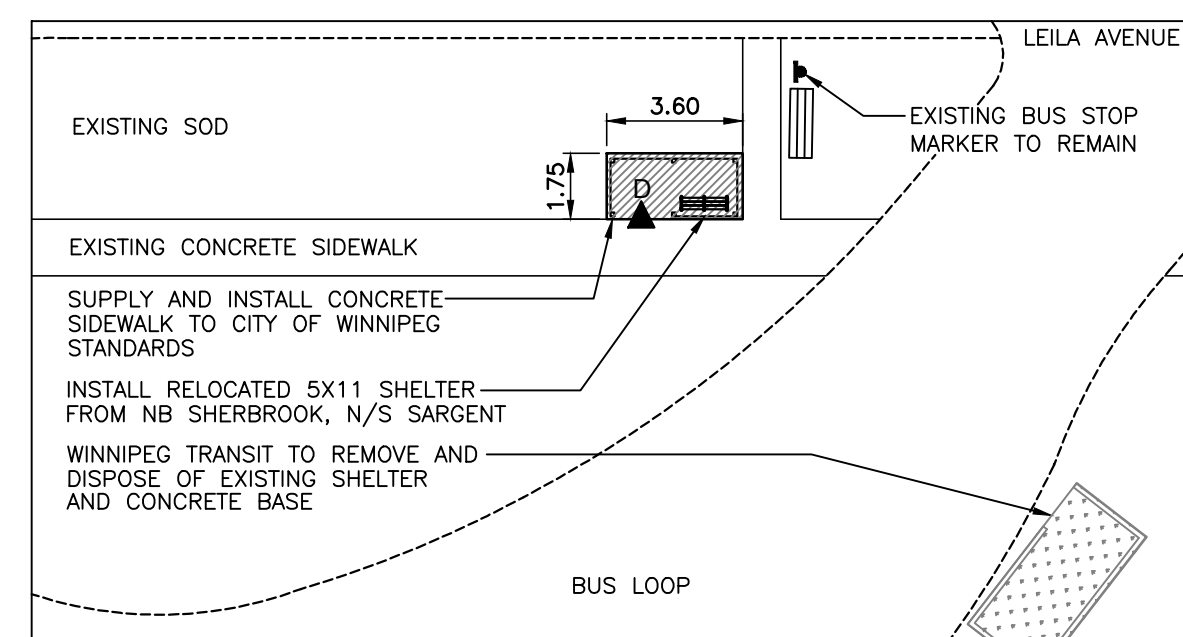

Eastbound Leila Bus Loop
Stop 30371 Leila Loop

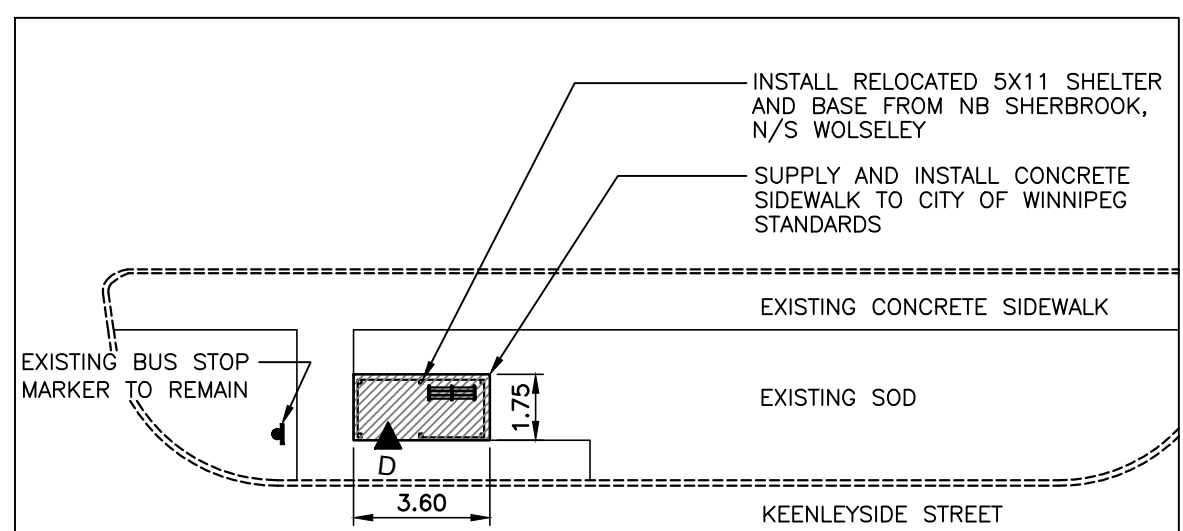

Westbound Keenleyside, N/S Kisil
Stop 40223 Kisil



LEGEND

- EXISTING**
- PROPERTY LINE
 - EXISTING CURB
 - EXISTING COBRA LIGHT POLE
 - EXISTING HYDRANT
 - BENCH TO BE REMOVED
 - MTS PHONE BOOTH
 - WASTE RECEPTACLE
 - EXISTING TREE TO REMAIN
 - EXISTING SIDEWALK TO BE REMOVED
 - EXISTING SIGN TO BE REMOVED
 - EXISTING TRAFFIC SIGNAL
 - EXISTING MAN HOLE
 - 5X11 DAYTECH SHELTER TO BE RELOCATED
 - ALUMINUM SHELTER TO BE REMOVED
- PROPOSED**
- HOLLAND PAVERS
 - ▬ PINNED CONCRETE CURB / CURB RENEWAL
 - ▨ PROPOSED CONCRETE SIDEWALK
 - ▩ SOD
 - RELOCATED 5X11 DAYTECH
 - CBS 5X11 SHELTER
 - ▲ DOOR LOCATION

No.	Revisions	Date	By
13-05-02	Scale	1:200	
MD	MD	JW	



Client
WINNIPEG TRANSIT
Project Title
BUS STOP IMPROVEMENTS
Sheet Title
SITWORKS LAYOUT PLANS
Project No.
06-029
Drawing No.
L1.2