



	FUNCTIONAL REQUIREMENTS SPECIFICATION - PLC	Document Code: 112577-0116-48ER-0001
		Revision: 00
Client: City of Winnipeg	Project: SEWPCC Ventilation Upgrades	Package / Area: Wet Well and Grit Electrical & Blower Room Ventilation

Prepared By: V. Elimban / C. Reimer			
	Name	Signature	Date
Checked By:	C. Reimer		2012-10-18
	Name	Signature	Date
Approved By:	C. Reimer		2012-10-18

<p>Certificate of Authorization</p>  <p>APEGM Certificate of Authorization SNC - Lavalin Inc. No. 4489 Date: <u>2013-04-30</u></p>	<p>Professional Seal</p>  <p>PROVINCE OF MANITOBA C. J. REIMER Member 21968 REGISTERED PROFESSIONAL ENGINEER</p> <p>2012-10-18 Rev 00</p>
---	--

REVISION REGISTER					
Rev.	Description	Date	By	Checked	Approved
00	Issued for Tender	2012-10-18	C. Reimer		



 SNC • LAVALIN	FUNCTIONAL REQUIREMENTS SPECIFICATION - PLC	Document Code: 112577-0116-48ER-0001
		Revision 00
Client: City of Winnipeg	Project: SEWPCC Ventilation Upgrades	Package / Area: Wet Well and Grit Electrical & Blower Room Ventilation

Table of Contents

1.0	Overview	3
1.1	Associated Documents	3
2.0	General Requirements	4
2.1	Human Machine Interface	4
2.2	HMI Animation Plan	5
2.3	Equipment and System General Requirements	11
3.0	Implementation	14
3.1	Navigation Buttons	14
3.2	Graphic Displays	14
3.3	Trend Displays	17
3.4	PLC Program	20
3.5	DCS Interface	21
4.0	Wet Well Ventilation System	22
4.1	Control Narrative	22
4.2	Wet Well Gas Detection Relay G5011-AY	23
4.3	Wet Well Ventilation State Controller G6001-FC	26
4.4	Wet Well Total Ventilation Rate G6002-FI	28
4.5	Wet Well Upper Level Supply G601-SF	29
4.6	Flow Transmitter G601-FT	33
4.7	Glycol Pump G603-GP	35
4.8	Flushing Water Control Valve G603-TV	37
4.9	Glycol Pump G605-GP	39
4.10	Hot Water Control Valve G605-TV	41
4.11	Wet Well Exhaust Fan G687-EF	43
4.12	Wet Well Pressure Controller G608-PC	46
4.13	Wet Well Lower Level Supply Fan, G602-FN	48
4.14	Flow Transmitter G602-FT	52
4.15	Wet Well Exhaust Fan, G686-EF	54
4.16	Miscellaneous	57
4.17	LCP-G1 Monitoring	59
4.18	Power Monitoring	60
5.0	Electrical Room and Blower Room	61
5.1	Control Narrative	61
5.2	Electrical Room AHU, G682-AHU	62
5.3	G682-AHU Mixed Air Temperature Controller G682-TC-3	64
5.4	G682-AHU Discharge Air Temperature Controller G682-TC-2	66
5.5	G682-AHU Heating Valve G682-TV-1	70
5.6	G682-AHU Cooling Valve G682-TV-2	72
5.7	Mixed Air Dampers – G682-FV-1, G682-FV-2	74
5.8	Pressure Controller G682-PC	77
5.9	Relief Air Damper G682-PV-3	79
5.10	Grit Electrical Room Temperature, G692-TT	80
5.11	Grit Electrical Room Exhaust Fan, G692-EF	81
5.12	LCP-G2 Monitoring	84
5.13	Power Monitoring	85

 SNC-LAVALIN	FUNCTIONAL REQUIREMENTS SPECIFICATION - PLC	Document Code: 112577-0116-48ER-0001
		Revision: 00
Client: City of Winnipeg	Project: SEWPCC Ventilation Upgrades	Package / Area: Wet Well and Grit Electrical & Blower Room Ventilation

1.0 OVERVIEW

This document is intended to provide a description of the PLC functionality for the SEWPCC Ventilation Upgrades. It is written from a technical perspective, and is intended to be read along with the associated Process & Instrument Diagram (P&ID) drawings and the Instrument Loop Drawings.

The ventilation systems within the scope of this specification are the following:

- Wet Well Ventilation System, and
- Grit Electrical and Blower Room Ventilation System

These systems are controlled by local PLCs and a local touchscreen HMI. The primary facility DCS will be integrated with the PLC systems via a Modbus TCP interface, however only general alarms and basic status information will be transmitted to the DCS. The DCS will not have any control capability for these ventilation systems.

1.1 Associated Documents

The Process and Instrument Diagrams that have been modified, in association with the included work, are listed below. Additional P&ID drawings may be referenced in this document.

Drawing Number	Description
1-0102G-A0026	Electrical Room and Boiler Room Cooling Units, G682-AHU
1-0102G-A0093	Wet Well Ventilation
1-0102G-A0094	Wet Well Upper Level HVAC, G601-SF
1-0102G-A0095	Wet Well Supply and Exhaust Fans G602-SF, G686-EF & G687-EF
1-0102G-A0096	Electrical Room Exhaust Fan, G692-EF

Note: The P&ID drawings for the facility were originally issued in the following numbering format:

1-0102x-G-Ayyyy

And the drawing number format has been subsequently modified to remove the document type identifier. All drawings referenced in this document utilize the new drawing number format, as shown below:

1-0102x-Ayyyy

The DCS functional requirements are identified in a separate document, identified as 12577-0116-48ER-0002.

 SNC-LAVALIN	FUNCTIONAL REQUIREMENTS SPECIFICATION - PLC	Document Code: 112577-0116-48ER-0001
		Revision 00
Client: City of Winnipeg	Project: SEWPCC Ventilation Upgrades	Package / Area: Wet Well and Grit Electrical & Blower Room Ventilation

2.0 GENERAL REQUIREMENTS

2.1 Human Machine Interface

2.1.1 Screen Layout

The typical screen layout for the touchscreen HMI graphic terminal shall be as shown in Figure 1. Navigation buttons shall reside across the bottom, a single-line alarm banner across the top, and the remainder of the screen allocated for the graphic display area. The graphic display area will be utilized for mimic displays, configuration screens, trends, and an alarm summary.

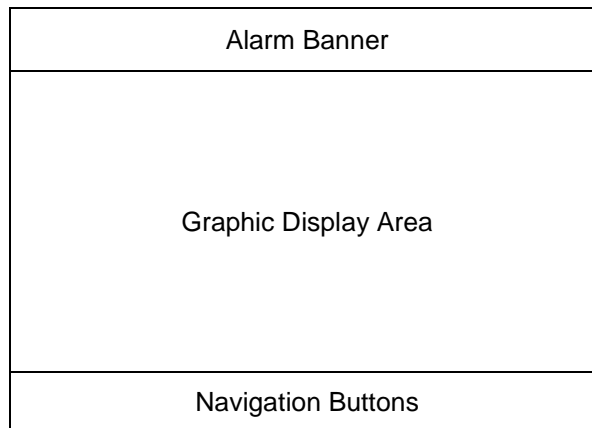



Figure 1: Screen Layout







2.1.2 Graphic Displays

A graphic (process mimic) display is a graphical representation of the process, showing pumps, instruments, and associated piping. Show sufficient detail from the P&IDs to allow operators a full understanding of the process. Metric units are to be used.





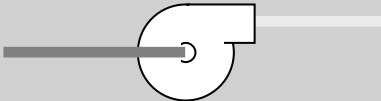
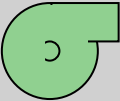

 SNC-LAVALIN	FUNCTIONAL REQUIREMENTS SPECIFICATION - PLC		Document Code: 112577-0116-48ER-0001
			Revision: 00
Client: City of Winnipeg	Project: SEWPCC Ventilation Upgrades	Package / Area:	Wet Well and Grit Electrical & Blower Room Ventilation

2.2 HMI Animation Plan





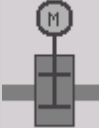
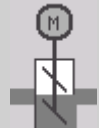

The HMI is to utilize a “shades-of-gray” color scheme where abnormal operating conditions are flagged to the operator via the use of bright colors. Follow the animation plan indicated below.

Item	Condition	Colors	Sample	Display Notes
Background	-	Gray 208		
Priority 1 Alarm	-	Red		Display adjacent to equipment
Priority 2 Alarm	-	Orange		Display adjacent to equipment
Priority 3 Alarm	-	Yellow		Display adjacent to equipment
Discrete State	Non-Active	Gray 192		Do not utilize for items that would be considered abnormal states.
	Active	Pale Green		
Control Mode (PLC) Flag	Auto	-	Invisible	
	Manual	Cyan Gray 64		
Local Mode Flag	Remote	-	Invisible	Local Switch is in Auto.
	Local	Cyan Gray 64		Display if local switch in Hand or Off
Starter Not Ready Flag	Ready	-	Invisible	
	Not Ready	Cyan Gray 64		
Equipment Graphic	Stopped	White 240 Gray 64		
	Running	Pale Green Gray 64		
On / Off Valve Position	Closed	White 240 Gray 64		
	Open	Gray 128 Gray 64		



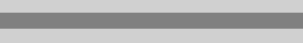

 SNC-LAVALIN	FUNCTIONAL REQUIREMENTS SPECIFICATION - PLC		Document Code: 112577-0116-48ER-0001
			Revision: 00
Client: City of Winnipeg	Project: SEWPCC Ventilation Upgrades	Package / Area: Wet Well and Grit Electrical & Blower Room Ventilation	

Item	Condition	Colors	Sample	Display Notes
	Partial	White 240 Gray 128 Gray 64		
	Invalid	White 240 Gray 64		
Modulating Valve Position	-	White 240 Gray 128 Gray 64		Horizontal Bar Graph Shows Position
Damper	Closed	White 240 Gray 64		
	Open	Gray 128 Gray 64		
	Partial	White 240 Gray 128 Gray 64		
	Invalid	White 240 Gray 64		
	Moving	Subdued Green White 240 Gray 128 Gray 64		Subdued green color is applicable to any actuator state where moving.
Analog Measurement Value	-	Black Text Gray 112	123.4 L/s	No faceplate link
		Gray 192 Black Text Gray 240 Gray 128 Gray 32	<div style="display: flex; justify-content: space-around; align-items: center;"> <div style="border: 1px solid gray; padding: 5px; background-color: #cccccc;">123.4 L/s</div> <div style="border: 1px solid gray; padding: 5px; background-color: #cccccc;">123.4 L/s 56.7 ACH</div> </div>	With faceplate link

 SNC-LAVALIN	FUNCTIONAL REQUIREMENTS SPECIFICATION - PLC		Document Code: 112577-0116-48ER-0001
			Revision: 00
Client: City of Winnipeg	Project: SEWPCC Ventilation Upgrades	Package / Area: Wet Well and Grit Electrical & Blower Room Ventilation	

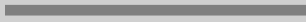
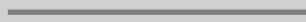
Item	Condition	Colors	Sample	Display Notes
Bar Graph	-	Background Gray 192 Text Gray 64 Indicator Gray 128 Threshold – As Per Table 2-2		Indicator to change color to abnormal state or alarm color upon exceeding threshold
Link to Trend				Display next to variable that is on trend.
Low Flow Switch	No Flow	White 240 Gray 128 Gray 96 Gray 64		
	Flow	Gray 160 Gray 128 Gray 96 Gray 64		
Low Temp Switch	Low	White 240 Gray 128 Gray 96 Gray 64		
	Normal	White 240 Gray 128 Gray 96 Gray 64		
Major Equipment ID Tag	-	Gray 64	G601-SF	Bold Text, adjacent to equipment. Do not show for minor equipment.
Minor Equipment ID Tag	-	Gray 96	G603-HC	Bold Text, adjacent to equipment. Do not show for minor equipment.
Major Headings		Gray 32	Wet Well Overview	
Minor Details		Gray 64	Pressure	
Piping – Path Lines - Major	-	Gray 128		6 Pt

 SNC-LAVALIN	FUNCTIONAL REQUIREMENTS SPECIFICATION - PLC		Document Code: 112577-0116-48ER-0001
			Revision: 00
Client: City of Winnipeg	Project: SEWPCC Ventilation Upgrades	Package / Area:	Wet Well and Grit Electrical & Blower Room Ventilation

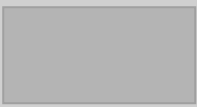
Item	Condition	Colors	Sample	Display Notes
Piping – Path Lines - Med	-	Gray 128		4 Pt
Piping – Path Lines - Minor	-	Gray 128		2 Pt
Ducting - Path Lines		Gray 128		8 Pt
Piping – Line Type	-	Gray 128		
Faceplate Background	-	Gray 192		
Faceplate Header	-	Gray 96 White		
Faceplate Border	-	Gray 160		
Trend Background	-	Gray 208		
Fill of static vessels				
Trend Pen Lines	-	Separate Contrasting Color for Each Pen	No sample	Do Not Use Alarm Colors
Pushbuttons	Enabled	Black Text	No sample	Pushbuttons are to appear bevelled.
	Disabled	Dk Gray Text		Utilize pushbuttons for a single purpose only. Do not change the text on a pushbutton.

Note: For instruments / sensors mounted on equipment, display actual field inputs (after moving to internal PLC variables) on the HMI equipment graphic. Utilize alarm variables for displaying the alarm flag and alarms in the list only.

 SNC-LAVALIN	FUNCTIONAL REQUIREMENTS SPECIFICATION - PLC	Document Code: 112577-0116-48ER-0001
		Revision 00
Client: City of Winnipeg	Project: SEWPCC Ventilation Upgrades	Package / Area: Wet Well and Grit Electrical & Blower Room Ventilation

2.2.1 RGB Colour Reference

Colour	Sample	RGB Ref	Notes
White		255,255,255	
White 240		240,240,240	
Gray 224		224,224,224	
Gray 208		208,208,208	
Gray 192		192,192,192	
Gray 176		176,176,176	
Gray 160		160,160,160	
Gray 144		144,144,144	
Gray 128		128,128,128	
Gray 112		112,112,112	
Gray 96		96,96,96	
Gray 64		64,64,64	
Gray 32		32,32,32	
Red		255,0,0	Use for Alarms Only
Pale Red		255,144,144	Acknowledged Priority 1 Alarm
Orange		255,128,0	Use for Alarms Only
Pale Orange		255,176,97	Acknowledged Priority 2 Alarm
Yellow		255,255,0	Use for Alarms Only
Pale Yellow		255,255,192	Acknowledged Priority 3 Alarm
Cyan		0,255,255	Use for Abnormal States Only
Green		0,255,0	Use for Trending
Pale Green		160,255,160	Future
Subdued Green		144,208,144	Use for equipment running status, and active states. Also utilize for target setpoint indication on graphs.
Blue		0,0,255	Use for Trending
Teal		64,128,128	Use for Trending
Magenta		255,0,255	Use for Trending
Dark Green		0,64,0	Use for Trending

2.2.2 Help Screen

Provide a help screen that includes a legend and clearly indicates to the operator the purpose of each graphical symbol.

 SNC-LAVALIN	FUNCTIONAL REQUIREMENTS SPECIFICATION - PLC	Document Code: 112577-0116-48ER-0001
		Revision 00
Client: City of Winnipeg	Project: SEWPCC Ventilation Upgrades	Package / Area: Wet Well and Grit Electrical & Blower Room Ventilation

2.2.3 Faceplates (Popup Windows)

Create popup faceplates for each major piece of equipment that has control capability. Display equipment faceplates upon a click of the associated equipment on the graphic display. Display the equipment identifier at the top of the faceplate. Display status information and provide for control as specified.

Where a piece of equipment has an alarm that requires a manual reset, include an alarm reset pushbutton at the bottom of the faceplate.

Provide a close button for the faceplate in the top right corner, with an “X” as the caption.

2.2.4 Touchscreen Links

Align touchscreen links to touchscreen physical input grid.

2.2.5 Trends

Incorporate pre-configured trend displays. Make trend displays accessible via a button(s) in the bottom right corner of the graphic display. Display a legend which relates the tag name and description to the pen colours.

Group trend screens by system.

2.2.6 Alarms

New alarms are to be displayed in an alarm banner that resides across the top of the screen.

Create an Alarm Summary screen so that operators are able to view historical alarms. The Alarm Summary object is to have the *Alarm List* property set to *History*. The alarm banner need not be shown when the alarm summary is displayed provided that the alarm summary also displays current (active) alarms.

Use the scheme in Table 2-1 display of alarms as a function of their state:

Priority	Active	Acknowledged	Returned
1	Red	Pale Red	Gray 208
2	Orange	Pale Orange	Gray 208
3	Yellow	Pale Yellow	Gray 208

Table 2-1: Alarm Summary Colours

For each alarm, configure a touch action, such that the appropriate detail graphic display is shown when the alarm is clicked.

2.2.7 Trend and Bar Graph Thresholds

Trend and bar graph threshold colors are to be as follows:

Priority	Indicator Color	Threshold Color
1	Red	(128,0,0)
2	Orange	(144,64,0)
3	Yellow	(144,144,0)
Abnormal State	Cyan	(0,112,112)
Setpoint	Gray 128	Subdued Green

Table 2-2: Graph Threshold Colors

 SNC-LAVALIN	FUNCTIONAL REQUIREMENTS SPECIFICATION - PLC		Document Code: 112577-0116-48ER-0001
			Revision: 00
Client: City of Winnipeg	Project: SEWPCC Ventilation Upgrades	Package / Area:	Wet Well and Grit Electrical & Blower Room Ventilation

2.2.8 PLC Control from HMI

Configure HMI commands to utilize a SET operation rather than the Momentary On operation. The PLC shall reset the bit. This prevents discrete PLC tags from being stuck on in the event of communication failures, timing issue, or control from multiple HMI nodes.

Enable and disable pushbuttons appropriately.

2.2.9 Security

Implement a logon / logoff security system. Allow for four levels of security: High (H), Medium (M), Low (L) and None (N)

When logged off, the security level will be None (N), however basic viewing of the HMI system will still be allowed.

Automatically logoff after 20 minutes of inactivity.

2.3 Equipment and System General Requirements

2.3.1 HMI Interface Points

Not all points between the HMI and PLC are necessarily specified or listed under the HMI-PLC interface lists. Note that in many cases the points listed as PLC I/O might also be part of the HMI-PLC interface. The requirement is based upon the HMI logging or display requirements.

2.3.2 HMI Interface Type Codes

R HMI Read
RA HMI Read, Alarmed
RW HMI Read/Write
W HMI Write
W1 HMI Write, PLC will immediately reset to 0

Multiple W1 variables may be assigned within a given word, as these bits will be immediately zeroed by the PLC, and thus should never experience issues with overwriting bits.

2.3.3 HMI Display Type

HMI Display Type	Description
-	Do not show on the HMI
EF-G	Show as graphic on the faceplate, which will popup when the operator clicks on the specific piece of equipment
EF-L	Show as an indicator light on the equipment faceplate.
EF-T	Show as a text display on the faceplate
EF-TE	Show as a text entry on the faceplate
EF2-*	Show as a 2 nd tab on the faceplate.
EF3-*	Show as a 3rd tab on the faceplate.
GD*-A	Show as an animation on the graphic display, where * is the level of the display.

 SNC-LAVALIN	FUNCTIONAL REQUIREMENTS SPECIFICATION - PLC	Document Code: 112577-0116-48ER-0001
		Revision 00
Client: City of Winnipeg	Project: SEWPCC Ventilation Upgrades	Package / Area: Wet Well and Grit Electrical & Blower Room Ventilation

HMI Display Type	Description
GD*-BG	Show as a bar graph on the graphic display, where * is the level of the display.
GD*-BGT	Show as a threshold / setpoint on a bar graph.
GD*-CA	Show as a common animation on the graphic display, where * is the level of the display. More than one variable may affect the same animation.
GD*-F	Show as a flag on the graphic display, where * is the level of the display.
GD*-G	Show as a graphic on the graphic display, where * is the level of the display.
GD*-L	Show as an indicator light on the graphic display, where * is the level of the display.
GD*-T	Show as text on the graphic display, where * is the level of the display.
SW-T	Show as text on a settings window.

Note:

- For Vijeo Designer, implementation of a second/third tab on the equipment faceplate will require creation of a second popup window.

Example:

Tag	Type	Description	HMI Display Type		
			0 State	1 State	Display
L501-EL	DI	Starter Ready	Not Ready	Ready	GD-T
L501-HS-4	DI	Starter in Remote Mode	Local	Remote	GD-T
L501-YS	DI	Bypass Mode	VFD	Bypass	GD-T

2.3.4 HMI Control Type

HMI Control Type	Description
-	Not Applicable
EF-PB	Show as a button on the equipment faceplate
EF-TE	Show as a text entry on the equipment faceplate
SW-CB	Show as a checkbox on the equipment settings window.
SW-TE	Show as a text entry on the equipment settings window.

 SNC-LAVALIN	FUNCTIONAL REQUIREMENTS SPECIFICATION - PLC	Document Code: 112577-0116-48ER-0001
		Revision 00
Client: City of Winnipeg	Project: SEWPCC Ventilation Upgrades	Package / Area: Wet Well and Grit Electrical & Blower Room Ventilation

2.3.5 Security

Security Type	Description
N	None
L	Low (Accessible to operator security level)
M	Medium (Accessible to senior operators only)
H	High (Accessible to maintenance only)

Example:

HMI Control Type

Security

Discrete Control Bits:

Tagname	Description	Type	Control
L501_CtrlManCmd	Set to Manual Control Mode	W1	EF-PB (L)
L501_CtrlAutoCmd	Set to Auto Control Mode	W1	EF-PB (L)

2.3.6 Alarm Priority

Pri	Description
1	Emergency / High Priority. The alarm requires immediate attention, Also, indicates a requirement for a callout when unmanned.
2	Medium (Warning) Priority. The alarm requires attention within approximately a day, but does not require a callout when unmanned.
3	Low (Advisory) Priority. The alarm does not require immediate attention.

 SNC-LAVALIN	FUNCTIONAL REQUIREMENTS SPECIFICATION - PLC	Document Code: 112577-0116-48ER-0001
		Revision 00
Client: City of Winnipeg	Project: SEWPCC Ventilation Upgrades	Package / Area: Wet Well and Grit Electrical & Blower Room Ventilation

3.0 IMPLEMENTATION

3.1 Navigation Buttons

The following navigation buttons are to be consistent across all displays:

- Home
- Login
- Logout
- Alarm Summary
- Left – All Level 3 displays are to have links to other Level 3 displays via left/right arrows. Similarly, all Level 4 displays are to have links to other Level 4 displays via left/right arrows.
- Up – All Level 3 displays are to link to the Level 2 display on pressing the Up arrow. All Level 4 displays are to link to the corresponding Level 3 display on pressing the Up arrow.
- Right – rotate screens in the opposite direction of the Left Arrow.

3.2 Graphic Displays

Create a process graphic (process mimic) display containing a representation of the process shown on the process and instrumentation diagrams. Below are the anticipated groupings of process displays. The equipment grouping on the displays may potentially be reorganized if required, upon approval of the Contract Administrator.

Note: As this is a local touchscreen, there are no Level 1 displays.

3.2.1 Grit Ventilation Overview

Level - 2

This is the default display for the system. Note that there are no Level 1 displays on this system.

Specific requirements include, but are not limited to:

- Display the following utilizing P&IDs 1-0102G-A0026 as a guide:
 - G682-AHU – Basic Fan Symbol in a box with Color Status and flags
 - Electrical and Blower Rooms
 - G692-TT Electrical Room Temperature
- Display the following utilizing P&ID 1-0102G-A0093 as a guide:
 - Wet Well
 - G601-SF – Basic Fan Symbol with Color Status and alarm flags
 - G602-SF – Basic Fan Symbol with Color Status and alarm flags
 - G686-EF – Basic Fan Symbol with Color Status and alarm flags
 - G687-EF – Basic Fan Symbol with Color Status and alarm flags
 - G6002-FI Effective Ventilation Rate in ACH – Bar Chart
- Provide links to the following graphics via area links
 - Wet Well HVAC Overview
 - G682-AHU Graphic
 - Control System Status

 SNC • LAVALIN	FUNCTIONAL REQUIREMENTS SPECIFICATION - PLC	Document Code: 112577-0116-48ER-0001
		Revision 00
Client: City of Winnipeg	Project: SEWPCC Ventilation Upgrades	Package / Area: Wet Well and Grit Electrical & Blower Room Ventilation

3.2.2 Wet Well HVAC Overview

Level - 3

Specific requirements include, but are not limited to:

- Display the following utilizing P&ID 1-0102G-A0093 as a guide:
 - Wet Well
 - G601-SF – Basic Fan Symbol with Color Status and flags
 - G602-SF – Basic Fan Symbol with Color Status and flags
 - G686-EF – Basic Fan Symbol with Color Status and flags
 - G687-EF – Basic Fan Symbol with Color Status and flags
 - G606-YS Occupied Status
 - G608-FI Differential Pressure – Bar Chart
 - G6002-FI Effective Ventilation Rate in ACH – Bar Chart
 - G601-SF Discharge Temp – Bar Chart
- Provide links to the following graphics via area links
 - Up One Level (Grit Ventilation Overview)
 - G601-SF Graphic
 - G602-SF Graphic
 - Wet Well Exhaust Fans Graphic
 - Headworks Gas Detection Graphic
- In addition to equipment faceplates, provide access to the following controller faceplates:
 - Wet Well Ventilation State Controller G6001-FC

3.2.3 Headworks Gas Detection Graphic

Level - 4

Specific requirements include, but are not limited to:

- Display bar graphs for the gas detection levels monitored.
- Indicator thresholds for H₂S sensors are to be:
 - 5 ppm → Priority 2 Alarm
 - 4 ppm → Abnormal State
- Indicator thresholds for methane and hydrocarbon sensors are to be:
 - 10% LEL → Priority 1 Alarm
 - 5% LEL → Abnormal State

3.2.4 G601-SF Graphic

Level - 4

Specific requirements include, but are not limited to:

- Display the equipment associated with G601-SF, the heat recovery system, and hot water reheat system following utilizing P&ID 1-0102G-A0094:
- In addition to equipment faceplates, provide access to the following controller faceplates:
 - Wet Well Ventilation State Controller G6001-FC

 SNC-LAVALIN	FUNCTIONAL REQUIREMENTS SPECIFICATION - PLC	Document Code: 112577-0116-48ER-0001
		Revision 00
Client: City of Winnipeg	Project: SEWPCC Ventilation Upgrades	Package / Area: Wet Well and Grit Electrical & Blower Room Ventilation

3.2.5 G602-SF Graphic

Level - 4

Specific requirements include, but are not limited to:

- Display the equipment associated with G602-SF utilizing P&ID 1-0102G-A0095:
- In addition to equipment faceplates, provide access to the following controller faceplates:
 - Wet Well Ventilation State Controller G6001-FC

3.2.6 Wet Well Exhaust Fans Graphic

Level - 4

Specific requirements include, but are not limited to:

- Display the equipment associated with exhaust fans G686-EF and G687-EF utilizing P&ID 1-0102G-A0095.
- In addition to equipment faceplates, provide access to the following controller faceplates:
 - Wet Well Ventilation State Controller G6001-FC

3.2.7 G682-AHU Graphic

Level - 4

Specific requirements include, but are not limited to:

- Display the equipment associated with G682-AHU and G692-EF utilizing P&ID 1-0102G-A0026 AND 1-0102G-A0096:
 - G682-AHU and all ancillary equipment.
 - G682-PDT (Display in Electrical Room box)
 - G682-TV-1
 - G682-TV-2
 - G692-TT (Display in Electrical Room box)
 - G692-EF

3.2.8 Control System Status

Level - 3

Create a Graphic Display with relevant items such as PLC health, connection to I/O faults, PLC battery status, 24 VDC power supplies, etc. Include:

- Control System Alarms and Status Info
- Items from Sections 4.17 and 5.12.

 SNC • LAVALIN	FUNCTIONAL REQUIREMENTS SPECIFICATION - PLC	Document Code: 112577-0116-48ER-0001
		Revision 00
Client: City of Winnipeg	Project: SEWPCC Ventilation Upgrades	Package / Area: Wet Well and Grit Electrical & Blower Room Ventilation

3.3 Trend Displays

3.3.1 Trends

Create, at minimum, the following trend displays, with the indicated pens.

Create appropriate links from the various graphic screens to the trend displays.

- G601-SF Flow Trend
 - G601-SC G601-SF Speed
 - G601-FT Wet Well Upper Level Air Flow
- G601-SF Air Temperatures
 - G601-TT-1 Outdoor Air Temperature
 - G603-TT-1 Supply Air Intermediate Temperature
 - G605-TT-1 Discharge Air Temperature
- G601-SF Heat Recovery System
 - G601-TT-1 Outdoor Air Temperature
 - G603-TT-1 Supply Air Intermediate Temperature
 - G603-TT-2 Flushing Water Supply Temp
 - G603-TT-3 Flushing Water Return Temp
 - G603-TC Flushing Water Control Valve Position
- G601-SF Hot Water Heating System
 - G603-TT-1 Supply Air Intermediate Temperature
 - G605-TT-1 Supply Air Discharge Temperature
 - G605-TC Hot Water Control Valve Position
- G602-SF Trend
 - G602-SC G602-SF Speed
 - G602-FT Wet Well Lower Level Air Flow
- G687-EF Trend
 - G687-SC G687-EF Speed Reference,
 - G608-PT Wet Well Upper Level Air Pressure,
- G608-PT Wet Well Pressure
 - G608-PDT Wet Well Differential Pressure
 - G601SC G601-SF Speed
 - G602-SC G602-SF Speed
 - G687-SC G687-EF Speed
 - G686-MM G686-EF Running (Scale to be visible on trend)
- G682-AHU Temperature Trend
 - G682-TT-1 Outdoor Air Temperature
 - G682-TT-2 Electrical Room and Boiler Room Supply Air Temperature
 - G682-TT-3 Electrical Room and Boiler Room Return Air Temperature
 - G692-TT Electrical Room Air Temperature – VFD Area

 SNC-LAVALIN	FUNCTIONAL REQUIREMENTS SPECIFICATION - PLC		Document Code: 112577-0116-48ER-0001
			Revision: 00
Client: City of Winnipeg	Project: SEWPCC Ventilation Upgrades	Package / Area: Wet Well and Grit Electrical & Blower Room Ventilation	

- G682-AHU Heating Trend
 - G682-TT-1 Outdoor Air Temperature
 - G682-TT-2 Electrical Room and Boiler Room Supply Air Temperature
 - G682-TT-3 Electrical Room and Boiler Room Return Air Temperature
 - G682-TY-1 Heating System Control Valve Position
- G682-AHU Cooling Trend
 - G682-TT-1 Outdoor Air Temperature
 - G682-TT-2 Electrical Room and Boiler Room Supply Air Temperature
 - G682-TT-3 Electrical Room and Boiler Room Return Air Temperature
 - G682-TY-2 Cooling System Control Valve Position
 - G682-FY-1 Outdoor Air Ratio Damper Position
- G682-PDT Electrical Room Pressure Trend
 - G682-PDT Electrical Room Differential Pressure
 - G682-FY-1 Outdoor Air Ratio Damper Position
 - G682-PY-3 Relief Air Damper Position
- G692-TT Electrical Room Temperature Trend
 - G682-TT-2 Electrical Room and Boiler Room Supply Air Temperature
 - G692-TT Electrical Room Air Temperature – VFD Area
 - G692-MM G692-EF Run Status

3.3.2 Logging Settings

The following is applicable to Vijeo Touchscreen HMIs.

Create a new logfile each day, and keep logfiles for 14 days.

3.3.3 Equipment Control Faceplates

Create equipment control faceplates for all controllable pieces of equipment and controllers. Note that a sample faceplate for SF-L1 is provided in Section 4.5.6. Base other faceplates on the example provided.

Each piece of equipment with manual control capability shall have a *Manual* and *Auto* pushbutton. A text display above the buttons will indicate the appropriate Manual or Auto mode that the equipment is currently in.

Disable all buttons that are not currently active or available. Examples:

- Disable the *Auto* button when in Auto mode.
- Disable the *Start* and *Stop* buttons when in Auto mode.
- Disable the *Manual Speed Entry* when in Auto mode.

Analog readings from air flow meters are to appear in both units of L/s and ACH on Level 4 detail screens. The speed reference of variable frequency drives, in units of %, are to appear adjacent to all fans powered by VFDs. Temperatures are to be displayed in degrees Celsius.

Each piece of equipment will have a software Automatic and Manual mode in addition to the physical Hand-Off-Auto switch at the MCC or local control panel. Add an “M” flag, cyan in colour, next to each piece of equipment and enable visibility animation such that the “M” only appears visible when the equipment is in software Manual mode. Make the “M” appear invisible when equipment is not in software Manual mode or when the Hand-Off-Auto switch is not in the Auto position.

 SNC-LAVALIN	FUNCTIONAL REQUIREMENTS SPECIFICATION - PLC		Document Code: 112577-0116-48ER-0001
			Revision 00
Client: City of Winnipeg	Project: SEWPCC Ventilation Upgrades	Package / Area:	Wet Well and Grit Electrical & Blower Room Ventilation

3.3.4 Pushbuttons

All pushbuttons shall be configured to use the SET operation rather than the Momentary On operation. The PLC shall reset the bit. This prevents PLC tags from being stuck on in the event of communication problems.

Pushbuttons are to appear bevelled and shall be grey in colour.

3.3.5 Popup Windows

Create popup windows for each pump and fan that summarize the states of all associated inputs and outputs. Incorporate touch animation on each pump, fan, and automated valve on the mimic displays so that when touched the corresponding popup window opens overtop the mimic display.

The popup windows for all pumps, fans, and automated valves shall have an Automatic and Manual mode button at the top of the popup. A string display, directly below the Automatic and Manual buttons, shall display the active mode. Pumps and fans will require manual-mode Start and Stop buttons that will be used to control the equipment while in software manual mode. Disable the Start and Stop button when the equipment is in software Automatic mode or the Hand-Off-Auto switch is not in the Auto position.

Variable frequency drives will require a manual speed setpoint numeric input box. Only permit numeric values in the range of 20% to 100% to prevent operators from running fans too slowly. Disable the manual setpoint numeric input when in Automatic mode.

 SNC-LAVALIN	FUNCTIONAL REQUIREMENTS SPECIFICATION - PLC	Document Code: 112577-0116-48ER-0001
		Revision 00
Client: City of Winnipeg	Project: SEWPCC Ventilation Upgrades	Package / Area: Wet Well and Grit Electrical & Blower Room Ventilation

3.3.6 Settings Windows

Create settings windows specific to each piece of equipment, shown as tabs on the popup windows. Where space is insufficient, utilize multiple tabs/windows.

3.3.7 Alarm Summary

Create an Alarm Summary screen so that operators are able to view historical alarms. The Alarm Summary object is to have the *Alarm List* property set to *History*.

3.4 PLC Program

The controlling devices are Schneider Electric Modicon M340 PLCs.

The following sections define the standards for the PLC program structure and implementation. The terminology used applies to the Modicon family of PLCs.

3.4.1 Program Structure

All logic is to reside in the MAST section. Create one section for each loop. For example, the following sections would be created for the Wet Well Ventilation system:

- G6001
- G6002
- G601
- G602
- G603
- G604
- G686
- G687
- Misc (G610, etc.)

3.4.2 Software Automatic/Manual Modes

In addition to the physical Hand-Off-Auto switch each device that is controlled by the PLC shall also have a software Automatic and Manual mode. The software Manual mode allows operators to manually control equipment from the HMI rather than the MCC room.

3.4.3 PIDs

The PLC logic shall be written such that bump-less transfer occurs when switching from Automatic to Manual, and vice versa. When a change from software Automatic mode to software Manual mode occurs, move the output of the PID into the Manual speed setpoint. This prevents the speed from changing when entering software Manual mode.

PIDs that are controlling variable frequency drives are to have their Lower Limit configured to be the same as the drive's minimum speed setting to prevent integral windup.

 SNC-LAVALIN	FUNCTIONAL REQUIREMENTS SPECIFICATION - PLC	Document Code: 112577-0116-48ER-0001
		Revision 00
Client: City of Winnipeg	Project: SEWPCC Ventilation Upgrades	Package / Area: Wet Well and Grit Electrical & Blower Room Ventilation

3.4.4 Variable Naming Convention

Variables are to be named using positive logic. For example, if a BOOL variable acted to lockout a pump when in a 0 State then the variable shall, for example, be named “PumpRunPermit” rather than “PumpLockout”.

3.4.5 Alarms

Some alarms are to automatically reset in the PLC if the input conditions causing the alarm are reset to normal. Other alarms require a reset from the HMI and therefore these alarms should be “sealed in”. For those alarms requiring a reset from the HMI ensure that the Reset bit is in the sealing branch so that if the alarm is active and the Reset button is pressed the alarm doesn’t get triggered again. Putting the Reset bit directly before the alarm bit will cause the alarm bit to momentarily transition to a 0 State then back to a 1 State, thus duplicating the alarm in the Alarm Summary window. An example ladder logic diagram is provided in Figure 2.

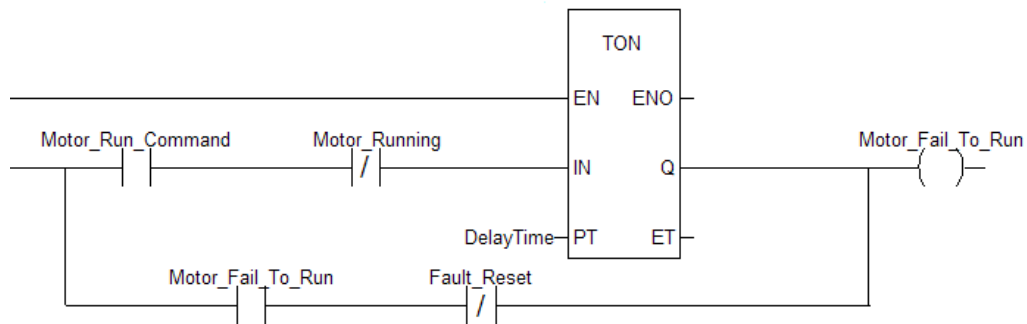

Figure 2: Sample Alarm Logic

An alternative would be to use a Set Coil and only reset the bit using a Reset Coil when the operator presses the HMI Fault Reset button.

3.4.6 Runtime Accumulators

Runtime accumulators are to be based upon a one minute internal PLC timer, which increments a 32-bit unsigned variable every minute of operation. The variable shall be scaled on the HMI to display in units of 0.0 hours.

3.5 DCS Interface

The DCS interface will be a Modbus TCP memory map interface. Provide a compacted memory map of the points specific to the DCS interface. Separate read and write data points.

Moves of data to and from the DCS interface map to be in a modular program section that can be disabled / deleted in the event of future DCS disconnection.

Review and implements the requirements noted in the DCS Functional Requirement Specification (112577-0116-48ER-0002). For example, it will be required to create common alarm tags for the DCS interface.

 SNC-LAVALIN	FUNCTIONAL REQUIREMENTS SPECIFICATION - PLC		Document Code: 112577-0116-48ER-0001
			Revision: 00
Client: City of Winnipeg	Project: SEWPCC Ventilation Upgrades	Package / Area: Wet Well and Grit Electrical & Blower Room Ventilation	

4.0 WET WELL VENTILATION SYSTEM

Implementation: PLC-G10

4.1 Control Narrative

4.1.1 Ventilation Equipment

The wet well is ventilated by two supply fans. Supply fan G601-SF will supply heated outdoor air to the wet well upper volume. Supply fan G602-SF will supply outdoor air to the wet well lower volume. Only one exhaust fan, G687-EF, will be operating normally and is sized to match the flow from both supply fans. The speed of G687-EF will be modulated to maintain a negative differential pressure in the space. Exhaust fan G686-EF will only operate in emergency situations, such as when G687-EF has failed or during a gas alarm.

G601-SF utilizes a heat recovery system to heat outdoor air. The heat recovery system draws heat from flushing water. Should the heat recovery system not be able to maintain setpoint temperature then a heat exchange system, utilizing boiler heated water, will run to provide the required additional heat. The heat recovery system and heat exchange system utilize modulating valves to control the transfer of heat.

Variable frequency drives allow speed modulation of the supply air fans to achieve design flow through the wet well chamber. Exhaust fan G687-EF is also powered by a VFD to allow the wet well chamber air pressure to be maintained at the setpoint. The wet well chamber air pressure will be drawn below atmospheric pressure so as to contain hazardous gases in the space.

4.1.2 Entry Station

An entry station will be installed outside the wet well chamber. The entry station will be linked to the wet well light switch to indicate to the control system when the space is occupied. When in the occupied mode, the system will increase the air flow in the wet well chamber. The entry station will also incorporate *Enter* and *Do Not Enter* lights to advise personnel when it is safe to enter. The *Enter* light will only be illuminated if a gas alarm does not exist and the design flow rate is achieved. If the light switch is on, and the system has not yet achieved the appropriate wet well ventilation, the *Do Not Enter light* will flash, providing feedback and indicating to personnel to wait, and not enter.

4.1.3 Design Flow

Design flow is a function of outdoor air temperature and occupancy. Design values are provided in Table 4-1.

Outdoor Air Temp	Upper Volume (360.4 m ³)		Lower Volume (904.0 m ³)	
	Unoccupied	Occupied	Unoccupied	Occupied
≥ 10°C (Summer)	12 ACH	12 ACH	12 ACH	12 ACH
< 10°C (Winter)	6 ACH	12 ACH	6 ACH	12 ACH

Table 4-1: Design Values

The PLC will determine the ventilation rate depending on the outdoor air temperature, occupancy, and the detection of hazardous gases. In case the outdoor air temperature sensor fails, the ventilation rate controls may be placed in manual to allow the operator to override the desired ventilation rate.

When operating in automatic mode and the outdoor air temperature is greater than or equal to 10°C for 60 min then the high-rate (Summer) ventilation rate will be selected. When operating in automatic mode and the outdoor air temperature is less than 10°C for 60 min then the low-rate (Winter) ventilation rate will be selected.

The wet well light switch will indicate occupancy and the air flow. When occupied, the air flow to the wet well will be increased during the Winter season. A design value of 12 ACH is selected when the wet well is occupied,

 SNC-LAVALIN	FUNCTIONAL REQUIREMENTS SPECIFICATION - PLC		Document Code: 112577-0116-48ER-0001
			Revision: 00
Client: City of Winnipeg	Project: SEWPCC Ventilation Upgrades	Package / Area: Wet Well and Grit Electrical & Blower Room Ventilation	

regardless of the outdoor air temperature. The occupancy switch will not have effect when the ventilation rate is already at a high-rate due to outdoor air temperature.

Once the number of air changes per hour are determined, the flow rate in units of L/s can be determined using the formula provided below.

$$\text{Flow Rate [L/s]} = \text{Design Value [ACH]} * \text{Volume [m}^3\text{]} * 1000 \text{ [L/m}^3\text{]} / 3600 \text{ [sec/hr]}$$

$$\text{Flow Rate} = \text{Design Value} * \text{Volume} / 3.6$$

The speed of the supply fans is set by high and low ventilation rate speed setpoints. A ramp time of 3%/sec will provide smooth transition during start-up and ventilation rate changes. The flow sensor installed on each supply fan is utilized for monitoring and alarming only. The flow sensor is not utilized for controls, to allow the exhaust fan pressure control to operate more effectively, and due to potential inaccuracies in the flow sensor.

4.2 Wet Well Gas Detection Relay G5011-AY

P&ID Drawing: 1-0102G-A0093 PLC: PLC-G10

The detected gas levels in the wet well, or other closely related areas, will turn on a higher rate of ventilation. The Wet Well Gas Detection Relay will provide a signal to G6001-FC, when to turn on a higher ventilation rate due to gas levels. A hardwired signal (Wet Well Gas Alarm) from GDC-G1 will turn on the highest rate (Emergency Rate) of ventilation. A hydrocarbon or H₂S level above a specified setpoint, will turn on a high rate of ventilation in the wet well. In addition, a hydrocarbon level above a specified setpoint in the Screen or Grit Rooms will turn on a high rate of ventilation.

4.2.1 PLC-I/O

Discrete:

Tag	Type	Description	0 State	1 State	Display
G501-AA	DI	Wet Well Gas Alarm	OK	Alarm	GD4-T

 SNC-LAVALIN	FUNCTIONAL REQUIREMENTS SPECIFICATION - PLC		Document Code: 112577-0116-48ER-0001
			Revision: 00
Client: City of Winnipeg	Project: SEWPCC Ventilation Upgrades	Package / Area:	Wet Well and Grit Electrical & Blower Room Ventilation

4.2.2 MODBUS Read Map

Read the following from GDC-G1 via Modbus TCP at 10 second intervals:

IP Address: XXX.XXX.XXX.XXX

Tag	Slave Node	Slave Register	Description	Range	Display
G501AT01	1	31001	Wet Well Area Methane Gas Level	0 – 100 %LEL	GD4-BG
G501AT02	1	31002	West Wet Well Hydrocarbon Gas Level	0 – 100 %LEL	GD4-BG
G501AT03	1	31003	East Wet Well Hydrocarbon Gas Level	0 – 100 %LEL	GD4-BG
G501AT04	1	31004	Wet Well Area H2S Gas Level	0 – 50 ppm	GD4-BG

Read the following from GDC-G2 via Modbus TCP at 10 second intervals:

IP Address: XXX.XXX.XXX.XXX

Tag	Slave Node	Slave Register	Description	Range	Display
G503AT01	2	31001	Screen Room Methane Gas Level	0 – 100 %LEL	GD4-BG
G503AT03	2	31003	Truck Bay Hydrocarbon Gas Level	0 – 100 %LEL	GD4-BG
G504AT01	2	31005	Grit Tank Room Methane Gas Level	0 – 100 %LEL	GD4-BG

Notes:

1. Analog data is returned as a 12 bit integer where 800 counts = 0 % and 4000 counts = 100 % of full range. For example, for H2S level, 800 counts = 0 ppm and 4000 counts = 50 ppm.

4.2.3 HMI – PLC Interface

Discrete Status Bits:

Tagname	Description	Type	Display
G5011_HighReq	High-Rate Ventilation Requested	R	GD4-T

4.2.4 PLC Generated Alarms

Tagname	Description	Logic	Pri	Reset
G501_AA	Wet Well Gas Alarm	G501-AA	2	Auto
GDC_G1_CommFail	GDC-G1 Communication Failure	No communication for 30 seconds	3	Auto

 SNC-LAVALIN	FUNCTIONAL REQUIREMENTS SPECIFICATION - PLC		Document Code: 112577-0116-48ER-0001
			Revision 00
Client: City of Winnipeg	Project: SEWPCC Ventilation Upgrades	Package / Area: Wet Well and Grit Electrical & Blower Room Ventilation	

Tagname	Description	Logic	Pri	Reset
GDC_G2_CommFail	GDC-G2 Communication Failure	No communication for 30 seconds	3	Auto

4.2.5 Control Narrative

Set G5011_HighReq = TRUE if any of the following are true for 30 seconds. Set to FALSE once no condition is true for 30 minutes.

- G501AT01 >= 5 %LEL
- G501AT02 >= 5 %LEL
- G501AT03 >= 5 %LEL
- G501AT04 >= 4 ppm
- G503AT01 >= 5 %LEL
- G503AT03 >= 5 %LEL
- G504AT01 >= 5 %LEL

 SNC-LAVALIN	FUNCTIONAL REQUIREMENTS SPECIFICATION - PLC	Document Code: 112577-0116-48ER-0001
		Revision 00
Client: City of Winnipeg	Project: SEWPCC Ventilation Upgrades	Package / Area: Wet Well and Grit Electrical & Blower Room Ventilation

4.3 Wet Well Ventilation State Controller G6001-FC

P&ID Drawing: N/A

PLC: PLC-G10

4.3.1 PLC-I/O

None

4.3.2 HMI – PLC Interface

Discrete Status Bits:

Tagname	Description	Type	Display
G6001_CtrlMan	Control Mode Manual	R	GD3-F GD4-F EF-T

Discrete Control Bits:

Tagname	Description	Type	Display
G6001_CtrlAutoCmd	Set to Auto Control Mode	W1	EF-PB (L)
G6001_CtrlManCmd	Set to Manual Control Mode	W1	EF-PB (L)
G6001_CtrlManOff	Set to Manual Off State	W1	EF-PB (L)
G6001_CtrlManLow	Set to Manual Low State	W1	EF-PB (L)
G6001_CtrlManHigh	Set to Manual High State	W1	EF-PB (L)
G6001_CtrlManEmerg	Set to Manual Emergency State	W1	EF-PB (L)

Analog Values:

Tagname	Description	Range	Type	Display
G6001_FC_State	Ventilation State	0-3	R	GD3-T GD4-T EF-T

States:
0 – Off
1 – Low
2 – High
3 – Emergency

Analog Set Points:

Tagname	Description	Range	Type	Display
G6001_FC_OccOffDly	Unoccupied Delay Time	0-360 sec	RW	EF-TE (H)

 SNC-LAVALIN	FUNCTIONAL REQUIREMENTS SPECIFICATION - PLC	Document Code: 112577-0116-48ER-0001
		Revision: 00
Client: City of Winnipeg	Project: SEWPCC Ventilation Upgrades	Package / Area: Wet Well and Grit Electrical & Blower Room Ventilation

4.3.3 PLC Generated Alarms

Tagname	Description	Logic	Pri	Reset
G6001_FA	No Wet Well Ventilation	NOT G601-MM AND NOT G602-MM for 60 secs	2	Auto

4.3.4 Control Narrative

The supply and exhaust fans will follow the state of G6001-FC to determine the appropriate desired ventilation rate. The state of G6001-FC is not a status feedback of the achieved ventilation, but rather a control of the desired ventilation.

In Auto mode, the state transitions will occur as indicated in Figure 3.

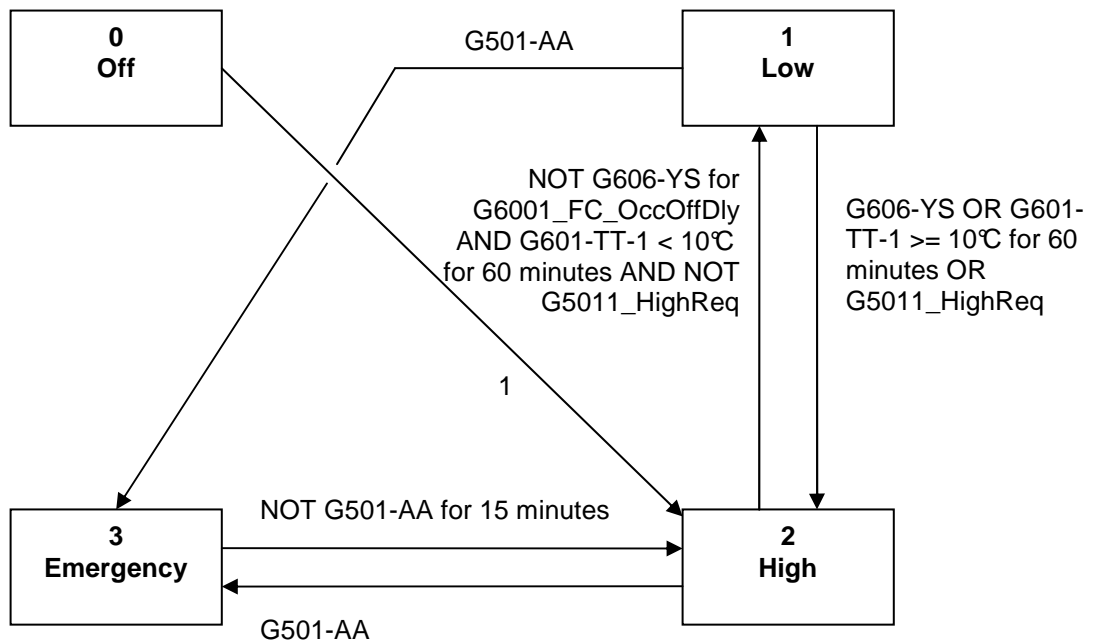



Figure 3 : G6001-FC State Diagram

 SNC-LAVALIN	FUNCTIONAL REQUIREMENTS SPECIFICATION - PLC	Document Code: 112577-0116-48ER-0001
		Revision 00
Client: City of Winnipeg	Project: SEWPCC Ventilation Upgrades	Package / Area: Wet Well and Grit Electrical & Blower Room Ventilation

4.4 Wet Well Total Ventilation Rate G6002-FI

P&ID Drawing: N/A

PLC: PLC-G10

The Total Ventilation Rate is the weighted average of the two effective ventilation rates for G601-SF and G602-SF.

4.4.1 PLC-I/O

None

4.4.2 HMI – PLC Interface

Analog Values:

Tagname	Description	Range	Type	Display
G6002_FI	Total Wet Well Ventilation Rate	0 – 15.0 ACH	R	GD2-BG

4.4.3 PLC Generated Alarms

None

4.4.4 Control Narrative

Set G6002_FI = 0.285 x G601-FI + 0.715 x G602-FI

 SNC-LAVALIN	FUNCTIONAL REQUIREMENTS SPECIFICATION - PLC		Document Code: 112577-0116-48ER-0001
			Revision: 00
Client: City of Winnipeg	Project: SEWPCC Ventilation Upgrades	Package / Area: Wet Well and Grit Electrical & Blower Room Ventilation	

4.5 Wet Well Upper Level Supply G601-SF

P&ID Drawing: 1-0102G-A0094 PLC: PLC-G10

Supply Fan G601-SF supplies heated outdoor air to the wet well upper level. It is shown on the wet well overview display and has a dedicated detail display.

4.5.1 PLC-I/O

Discrete:

Tag	Type	Description	0 State	1 State	Display
G601-UL	DI	G601-SF Starter Ready	Not Ready	Ready	GD3-F GD4-F
G601-YS	DI	G601-SF Auto Mode	Not Auto	Auto	GD3-F GD4-F
G601-MM	DI	G601-SF Running	Stopped	Running	GD3-A GD4-A
G601-MN	DO	G601-SF Run Command	Stop	Run	-
G601-PDS	DI	Outdoor Air Filter Plugged	Not Plugged	Plugged	GD4-A
G601-ZSC-1	DI	Inlet Damper Closed	Not Closed	Closed	GD4-A
G601-ZSO-1	DI	Inlet Damper Fully Open	Not Fully Open	Fully Open	GD4-A
G601-ZSC-2	DI	Outlet Damper Closed	Not Closed	Closed	GD4-A
G601-ZSO-2	DI	Outlet Damper Fully Open	Not Fully Open	Fully Open	GD4-A

Analog:

Tag	Type	Description	Range	Display
G601-TT-1	AI	G601-SF Outdoor Air Temperature	-40 - 40°C	GD4-T
G601-SY	AO	G601-SF Speed Control	0-100%	

 SNC • LAVALIN	FUNCTIONAL REQUIREMENTS SPECIFICATION - PLC		Document Code: 112577-0116-48ER-0001
			Revision: 00
Client: City of Winnipeg	Project: SEWPCC Ventilation Upgrades	Package / Area:	Wet Well and Grit Electrical & Blower Room Ventilation

4.5.2 HMI – PLC Interface

Discrete Status Bits:

Tagname	Description	Type	Display
G601_CtrlMan	Control Mode Manual	R	GD3-F GD4-F EF-T
G601_Intlk	Interlocked	R	GD3-F GD4-F

Discrete Control Bits:

Tagname	Description	Type	Display
G601_CtrlAutoCmd	Set to Auto Control Mode	W1	EF-PB (L)
G601_CtrlManCmd	Set to Manual Control Mode	W1	EF-PB (L)
G601_Reset	Reset	W1	EF-PB (L)
G601_ManualStart	Manual Start Command	W1	EF-PB (L)
G601_ManualStop	Manual Stop Command	W1	EF-PB (L)
G601_KQ_Reset	Runtime Totalizer Reset	W1	EF2-PB (L)

Analog Values:

Tagname	Description	Range	Type	Display
G601_SI	Speed	0 – 100%	R	GD4-T
G601_KQI	Runtime	0 - 2 ³² -1 min	R	EF-T

Analog Set Points:

Tagname	Description	Range	Type	Display
G601-SC_Man	Manual Speed Control Output	0-100%	RW	EF-TE (L)
G601-SC_Min	Minimum Speed Control Output	0-100%	RW	EF2-TE (H)
G601-SC_Low	Speed – Low Ventilation Rate	0-100%	RW	EF2-TE (H)
G601-SC_High	Speed – High Ventilation Rate	0-100%	RW	EF2-TE (H)
G601-SC_Emerg	Speed – Emergency Ventilation Rate	0-100%	RW	EF2-TE (H)

 SNC-LAVALIN	FUNCTIONAL REQUIREMENTS SPECIFICATION - PLC		Document Code: 112577-0116-48ER-0001
			Revision: 00
Client: City of Winnipeg	Project: SEWPCC Ventilation Upgrades	Package / Area: Wet Well and Grit Electrical & Blower Room Ventilation	

4.5.3 PLC Generated Alarms

Tagname	Description	Logic	Pri	Reset
G601_RunFault	G601-SF Run Fault	NOT G551_ESL AND G601-YS AND ((G601-MM AND NOT(G601-MN) for 0.5 sec OR (G601-MN AND NOT (G601-ZSC-1 OR G601-ZSC-2) AND NOT (G601-MM) for 0.5 sec) Auto Reset on G551_ESL	2	Manual
G601_PA	G601-SF Filter Plugged	G601-PDS for 10 sec. Auto reset if NOT G601-PDS for 30 secs	3	Auto
G601-ZAO-1	G601-XV-1 Damper Open Fault	G601-YS AND G601-MN AND (G601-ZSC-1 for 15 sec OR NOT G601-ZSO-1 for 120 secs)	2	Auto
G601-ZAC-1	G601-XV-1 Damper Close Fault	G601-YS AND NOT G601-MN AND NOT G601-ZSC-1 for 3 min	3	Auto
G601-ZAO-2	G601-XV-2 Damper Open Fault	G601-YS AND G601-MN AND (G601-ZSC-2 for 15 sec OR NOT G601-ZSO-2 for 120 secs)	2	Auto
G601-ZAC-2	G601-XV-2 Damper Close Fault	G601-YS AND NOT G601-MN AND NOT G601-ZSC-2 for 3 min	3	Auto

4.5.4 Interlocks

Initiating Event	Action	Control Mode		Display Interlock	Description
		Auto	Manual		
G551_ESL	Stop	Y	Y	Y	Stop G601-SF on a MCC-1G power fail
NOT G601-UL OR NOT G601-YS	Stop	Y	Y	N	Turn off the Run Cmd output if the starter is not ready or not in Auto
NOT (G686-MM OR G687-MM) for 0.5 seconds	Set to Minimum Speed	Y	N	Y	Initially, set G601-SF to minimum speed if exhaust fans have failed.
NOT (G601-ZSO-1 AND G601-ZSO-2)	Set to Minimum Speed	Y	N	Y	Keep G601-SF at minimum speed until the dampers are fully open.
NOT (G686-MM OR G687-MM) for 15 seconds	Stop	Y	N	Y	Stop G601-SF if exhaust fans have failed
G601_RunFault	Stop	Y	Y	N	Stop G601-SF if there is a Run Fault
G601-MM AND (G601-ZCS-1 OR G601-ZSC-2)	Stop	Y	Y	N	Stop if either inlet or outlet dampers are closed
G501-AA	Run at full speed	Y	Y	Y	Run at full speed upon a gas alarm.

 SNC-LAVALIN	FUNCTIONAL REQUIREMENTS SPECIFICATION - PLC	Document Code: 112577-0116-48ER-0001
		Revision 00
Client: City of Winnipeg	Project: SEWPCC Ventilation Upgrades	Package / Area: Wet Well and Grit Electrical & Blower Room Ventilation

4.5.5 Control Narrative

The speed of the fan is set by the state of the system ventilation controller, G601-State.

- 0 (Off) G601-SC=0
- 1 (Low) G601-SC= G601-SC_Low
- 2 (High) G601-SC= G601-SC_High
- 3 (Emergency) G601-SC= G601-SC_Emerg

Utilize a rate limiter to control the rate of the speed transitions. Set the value during commissioning, but it is expected that the rate will be approximately 3%/sec. Bypass the rate limiter on a transition to the off state.

Create a *Dampers Opening* text animation on the equipment faceplate, that is active when G601-MN and NOT (G601-ZSO-1 AND G601-ZSO-2).

4.5.6 Faceplate

An example faceplate is shown in Figure 4.

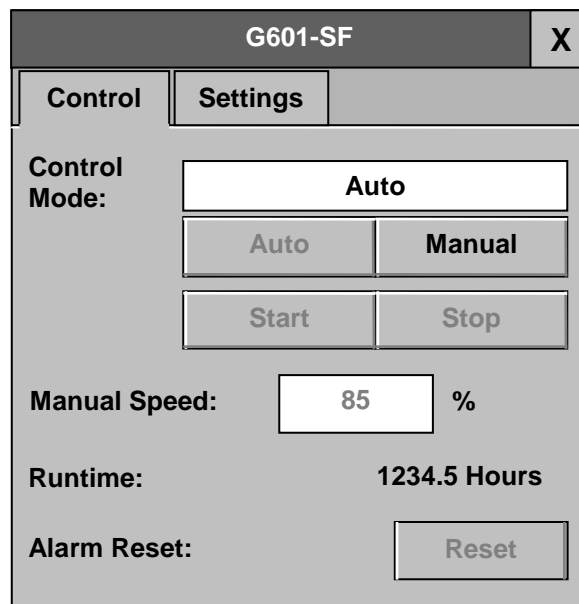



Figure 4: SF-G601 Equipment Faceplate 1/2

Notes:

1. Clicking on the Fan on the Process Graphic will bring up the Equipment Faceplate 1/2.
2. Press the Settings tab to bring up the Equipment Faceplate 2/2 (Not Shown).

 SNC-LAVALIN	FUNCTIONAL REQUIREMENTS SPECIFICATION - PLC		Document Code: 112577-0116-48ER-0001
			Revision 00
Client: City of Winnipeg	Project: SEWPCC Ventilation Upgrades	Package / Area: Wet Well and Grit Electrical & Blower Room Ventilation	

4.6 Flow Transmitter G601-FT

P&ID Drawing: 1-0102G-A0094 PLC: PLC-G10

G601-FT measures the flow of air discharged by supply fan G601-SF.

4.6.1 PLC-I/O

Discrete:

N/A

Analog:

Tag	Type	Description	Range	Display
G601-FT	AI	G601-SF Flow Transmitter	0-1500 l/s	

4.6.2 HMI – PLC Interface

Analog Values:

Tagname	Description	Range	Type	Display
G601_FI	G601-SF Airflow (ACH)	0-14.98 ACH	R	GD3-BG GD4-T
G601_FI_2	G601-SF Airflow (L/s)	0-1500 l/s	R	GD4-T
G601_FI_SP	G601-SF Current Air Flow Setpoint	0-15 ACH	R	GD3-BGT EF-T
G601_FAL_SP	G601-SF Current Low Flow Alarm Setpoint	0-15 ACH	R	GD3-BGT EF-T
G601_FAH_SP	G601-SF Current High Flow Alarm Setpoint	0-15 ACH	R	GD3-BGT EF-T

Analog Set Points:

Tagname	Description	Range	Type	Display
G601_FAL_SPd	Low Flow Alarm Deviation Setpoint	0-15 ACH	RW	EF2-TE (H)
G601_FALL_SP	Low-Low Flow Alarm Setpoint	0-15 ACH	RW	EF2-TE (H) GD3-BGT
G601_FAH_SPd	High Flow Alarm Deviation Setpoint	0-15 ACH	RW	EF2-TE (H)
G601_FI_1_SP	Low Rate Setpoint	0-15 ACH	RW	EF2-TE (H)
G601_FI_2_SP	High Rate Setpoint	0-15 ACH	RW	EF2-TE (H)
G601_FI_3_SP	Emergency Rate Setpoint	0-15 ACH	RW	EF2-TE (H)

 SNC-LAVALIN	FUNCTIONAL REQUIREMENTS SPECIFICATION - PLC		Document Code: 112577-0116-48ER-0001
			Revision 00
Client: City of Winnipeg	Project: SEWPCC Ventilation Upgrades	Package / Area: Wet Well and Grit Electrical & Blower Room Ventilation	

4.6.3 PLC Generated Alarms

Tagname	Description	Logic	Pri	Reset
G601_FAF	G601-FT Transmitter Failure	G601-FT < 4 mA or > 20 mA	3	Auto
G601_FAL	G601-SF Low Flow	NOT G601-FAF AND G601-MM AND G601-FT <= G601_FAL_SP for > 60 secs	3	Auto
G601_FALL	G601-SF Low-Low Flow	NOT G601-FAF AND G601-MM AND G601-FT <= G601_FALL_SP for > 60 secs	2	Auto
G601_FAH	G601-SF High Flow	NOT G601-FAF AND G601-MM AND G601-FT >= G601_FAH_SP for > 60 secs	3	Auto

Generate common alarm G601_SF_Alm as a combination of the above.

4.6.4 Interlocks

N/A

4.6.5 Control Narrative

Flow Transmitter G601-FT is used for monitoring and alarming only.

Set the current flow setpoint based upon the wet well Ventilation State Controller G6001-FC.

Set G601_FAL_SP = G601_FT_SP - G601_FAL_SPd

Set G601_FAH_SP = G601_FT_SP - G601_FAH_SPd

 SNC-LAVALIN	FUNCTIONAL REQUIREMENTS SPECIFICATION - PLC		Document Code: 112577-0116-48ER-0001
			Revision 00
Client: City of Winnipeg	Project: SEWPCC Ventilation Upgrades	Package / Area: Wet Well and Grit Electrical & Blower Room Ventilation	

4.7 Glycol Pump G603-GP

P&ID Drawing: 1-0102G-A0094 PLC: PLC-G10

Glycol pump G603-GP circulates glycol in the flushing water heat recovery system.

4.7.1 PLC-I/O

Discrete:

Tag	Type	Description	0 State	1 State	Display
G603-UL	DI	Glycol Pump G603-GP Starter Ready	Not Ready	Ready	GD4-T
G603-YS	DI	Glycol Pump G603-GP Auto Mode	Not Auto	Auto	GD4-T
G603-MM	DI	Glycol Pump G603-GP Running	Stopped	Running	GD4-A
G603-FSL	DI	Glycol Pump G603-GP Flow Switch	No Flow	Flow	GD4-A
G603-MN	DO	Glycol Pump G603-GP Run Command	Stop	Run	-

4.7.2 Local HMI – PLC Interface

Discrete Status Bits:

Tagname	Description	Type	Display
G603_GP_CtrlMan	Control Mode Manual	R	GD4-F EF-T
G603_GP_Intlk	Interlocked	R	GD4-F

Discrete Control Bits:

Tagname	Description	Type	Display
G603_GP_CtrlAutoCmd	Set to Auto Control Mode	W1	EF-PB (L)
G603_GP_CtrlManCmd	Set to Manual Control Mode	W1	EF-PB (L)
G603_GP_ManualStart	Manual Start Command	W1	EF-PB (L)
G603_GP_ManualStop	Manual Stop Command	W1	EF-PB (L)
G603_GP_Reset	Reset	W1	EF-PB (L)
G603_KQ_Reset	Runtime Totalizer Reset	W1	EF-PB (L)

Analog Values:

Tagname	Description	Range	Type	Display
G603_KQI	Runtime	0 - 2 ³² -1 min	R	EF-T

 SNC-LAVALIN	FUNCTIONAL REQUIREMENTS SPECIFICATION - PLC		Document Code: 112577-0116-48ER-0001
			Revision 00
Client: City of Winnipeg	Project: SEWPCC Ventilation Upgrades	Package / Area: Wet Well and Grit Electrical & Blower Room Ventilation	

4.7.3 PLC Generated Alarms

Tagname	Description	Logic	Pri	Reset
G603_FAL	G603-GP No Flow	G603-MM AND NOT (G603-FSL) for > 5 secs	3	Manual
G603_RunFault	G603-GP Run Fault	NOT G551_ESL AND G603-YS AND ((G603-MM AND NOT G603-MN) for 0.5 sec OR (G603-MN AND NOT G603-MM for 0.5 sec)) Auto Reset on G551_ESL	3	Manual
G603-YA	G603-GP Heat Recovery System Not Active	NOT (G603_FAL OR G603_RunFault) AND NOT G603-MM AND G603-TT-1 < (G605-TC-SP – 2) for 30 minutes	3	Auto

4.7.4 Interlocks

Initiating Event	Action	Control Mode		Display Interlock	Description
		Auto	Manual		
G551_ESL	Stop	Y	Y	Y	Stop the pump on a MCC-1G power fail.
G603_FAL	Stop	Y	N	N	Stop the pump on a No Flow Alarm
G603_RunFault	Stop	Y	Y	N	Stop the pump if there is a G603-GP Run Fault
G603_TT_3_TAL	Stop	Y	N	Y	Stop the pump if G603-HE flushing water discharge temperature is low

4.7.5 Control Narrative

G603-GP is to run if G603-TT-1 is at least 1°C below the setpoint temperature for 5 minutes while G601-SF is running. G603-GP is to stop if the PID output, controlling G603-TC, is 0 for two minutes.

IF Auto Mode (G603-YS)

IF (NOT G603_GP_CtrlMan)

IF (G603-TT-1 ≤ G605-TC-SP – 1 AND G601-MM = 1 for > 5 minutes) // start the pump

Set G603-MN=1 // start the pump

IF (G603-MM AND G603-TC = 0 for > two minutes)

Set G603-MN= 0 // stop the pump

Else // Manual Mode, PLC does not have control of the pump

Set G603-MN=0

 SNC-LAVALIN	FUNCTIONAL REQUIREMENTS SPECIFICATION - PLC		Document Code: 112577-0116-48ER-0001
			Revision: 00
Client: City of Winnipeg	Project: SEWPCC Ventilation Upgrades	Package / Area: Wet Well and Grit Electrical & Blower Room Ventilation	

4.8 Flushing Water Control Valve G603-TV

P&ID Drawing: 1-0102G-A0094 PLC: PLC-G10

G603-TV is a modulating valve in the flushing water heat recovery system. The valve is located on the flushing water return line and is controlled by a PID loop to maintain the setpoint temperature at G603-TT-1

4.8.1 PLC-I/O

Analog:

Tag	Type	Description	Range	Display
G603-TT-1	AI	G601-SF Intermediate Temperature	-40-60 °C	GD4-T
G603-TT-2	AI	G603-HE Flushing Water Inlet Temperature	-10-30 °C	GD4-T
G603-TT-3	AI	G603-HE Flushing Water Discharge Temperature	-10-30 °C	GD4-T
G603-TY	AO	G603-TV Position Output	0 – 100% (See Note 1)	GD4-T

1. Invert output such that 0% = Fully Open as the last step in setting analog output. All internal variables and the display should read 100% = Fully Open. All references in this document refer to 0% as closed.

4.8.2 HMI – PLC Interface

Discrete Status Bits:

Tagname	Description	Type	Display
G603_TV_CtrlMan	Control Mode Manual	R	GD4-F EF-T

Discrete Control Bits:

Tagname	Description	Type	Display
G603_TV_CtrlAutoCmd	Set to Auto Control Mode	W1	EF-PB (L)
G603_TV_CtrlManCmd	Set to Manual Control Mode	W1	EF-PB (L)

Analog Set Points:

Tagname	Description	Range	Type	Display
G603_TV_ZMan	Manual Position Output	0-100%	RW	EF-TE (L)

 SNC-LAVALIN	FUNCTIONAL REQUIREMENTS SPECIFICATION - PLC		Document Code: 112577-0116-48ER-0001
			Revision 00
Client: City of Winnipeg	Project: SEWPCC Ventilation Upgrades	Package / Area: Wet Well and Grit Electrical & Blower Room Ventilation	

4.8.3 PLC Generated Alarms

Tagname	Description	Logic	Pri	Reset
G603_TT_1_Fail	G603-TT-1 Transmitter Fail	G603-TT-1 < 4 mA or > 20 mA	3	Auto
G603_TT_2_Fail	G603-TT-2 Transmitter Fail	G603-TT-2 < 4 mA or > 20 mA	3	Auto
G603_TT_3_Fail	G603-TT-3 Transmitter Fail	G603-TT-3 < 4 mA or > 20 mA	3	Auto
G603_TT_2_TAL	G603-HE FW Supply Temperature Low	NOT G603_TAF_2 AND G603-TT-2 ≤ 9°C for > 1 minute	3	Auto
G603_TT_3_TAL	G603-HE FW Discharge Temperature Low	NOT G603_TAF_3 AND G603-TT-3 ≤ 4°C for > 1 minute Reset after G603-TT-3 ≥ 6°C for 6 min	3	Auto

4.8.4 Interlocks

Initiating Event	Action	Control Mode		Display Interlock	Description
		Auto	Manual		
NOT (G603-MM)	G603-TC= 0	Y	N	N	Close Intake Valve when G603-GP is stopped

4.8.5 Control Narrative

Utilize PID control to control the flushing water position valve, to achieve desired air temperature at G603-TT-1:

PV: G603-TT-1

SP: G605_TC_SP

CV: G603-TC (Reverse Acting)

The position of the flushing water control valve is based on the output of the temperature controller G605-TC. As the air supply temperature cools, the supply temperature PID controller will open the control valve G603-TV to provide heating. Enable the PID loop only after G603-GP has started to prevent integral windup.

 SNC-LAVALIN	FUNCTIONAL REQUIREMENTS SPECIFICATION - PLC	Document Code: 112577-0116-48ER-0001
		Revision 00
Client: City of Winnipeg	Project: SEWPCC Ventilation Upgrades	Package / Area: Wet Well and Grit Electrical & Blower Room Ventilation

4.9 Glycol Pump G605-GP

P&ID Drawing: 1-0102G-A0094 PLC: PLC-G10

Glycol Pump G605-GP circulates glycol in the hot water heat exchange system. G605-GP in the heat exchange system is designed to run once the heat recovery system can no longer maintain the setpoint temperature at G603-TT-1.

4.9.1 PLC-I/O

Discrete:

Tag	Type	Description	0 State	1 State	Display
G605-UL	DI	Glycol Pump G605-GP Starter Ready	Not Ready	Ready	GD4-T
G605-YS	DI	Glycol Pump G605-GP Auto Mode	Not Auto	Auto	GD4-T
G605-MM	DI	Glycol Pump G605-GP Running	Stopped	Running	GD4-A
G605-FSL	DI	Glycol Pump G605-GP Flow Switch	No Flow	Flow	GD4-A
G605-MN	DO	Glycol Pump G605-GP Run Command	Stop	Run	

4.9.2 Local HMI – PLC Interface

Discrete Status Bits:

Tagname	Description	Type	Display
G605_GP_CtrlMan	Control Mode Manual	R	GD4-F EF-T
G605_Intlk	Interlocked	R	GD4-F

Discrete Control Bits:

Tagname	Description	Type	Display
G605_GP_CtrlAutoCmd	Set to Auto Control Mode	W1	EF-PB (L)
G605_GP_CtrlManCmd	Set to Manual Control Mode	W1	EF-PB (L)
G605_GP_ManualStart	Manual Start Command	W1	EF-PB (L)
G605_GP_ManualStop	Manual Stop Command	W1	EF-PB (L)
G605_Reset	Reset	W1	EF-PB (L)
G605_KQ_Reset	Runtime Totalizer Reset	W1	EF-PB (L)

 SNC-LAVALIN	FUNCTIONAL REQUIREMENTS SPECIFICATION - PLC	Document Code: 112577-0116-48ER-0001
		Revision 00
Client: City of Winnipeg	Project: SEWPCC Ventilation Upgrades	Package / Area: Wet Well and Grit Electrical & Blower Room Ventilation

Analog Values:

Tagname	Description	Range	Type	Display
G605_KQI	Runtime	0 - 2 ³² -1 min	R	EF-T

Analog Set Points:

N/A

4.9.3 PLC Generated Alarms

Tagname	Description	Logic	Pri	Reset
G605_FAL	G605-GP No Flow Alarm	G605-MM and NOT (G605-FSL) for > 5 seconds	3	Manual
G605_RunFault	G605-GP Run Fault	NOT G551_ESL AND G605-YS AND ((G605-MM AND NOT G605-MN) for 0.5 sec OR (G605-MN AND NOT G605-MM) for 0.5 sec) Auto Reset on G551_ESL	3	Manual

4.9.4 Interlocks

Initiating Event	Action	Control Mode		Display Interlock	Description
		Auto	Manual		
G551_ESL	Stop	Y	Y	Y	Stop the pump on a MCC-1G power fail
G605-FAL	Stop	Y	N	N	Stop the pump on a No Flow Alarm
G605_RunFault	Stop	Y	Y	N	Stop the pump if there is a G605-GP Run Fault

4.9.5 Control Narrative

G605-GP is to run if the temperature at G605-TT is at least 1°C below the setpoint for 5 minutes. G605 -GP is to stop if the PID output, controlling G605-TC, is 0 for 5 minutes.

IF Auto Mode (G605-YS)

IF (NOT G605_CtrlMan)

IF (G605-TT ≤ G605_TC_SP - 1 for ≥ 5 minutes)

Set G605-MN =1 // Start the pump

IF (G605-MM AND G605-TC = 0 for > 5 minutes)

Set G605-MN=0 // Stop the pump

Else // Manual mode, PLC does not have control of the pump

Set G605-MN=0

 SNC-LAVALIN	FUNCTIONAL REQUIREMENTS SPECIFICATION - PLC		Document Code: 112577-0116-48ER-0001
			Revision: 00
Client: City of Winnipeg	Project: SEWPCC Ventilation Upgrades	Package / Area: Wet Well and Grit Electrical & Blower Room Ventilation	

4.10 Hot Water Control Valve G605-TV

P&ID Drawing: 1-0102G-A0094 PLC: PLC-G10

G605-TV is a modulating valve used to control the amount of hot water heated glycol that flows to the G605-HC Heating Coil, which is associated with the G601-SF supply fan. The valve is controlled by a PID loop to maintain the setpoint temperature at G605-TT.

4.10.1 PLC-I/O

Analog:

Tag	Type	Description	Range	Display
G605-TT	AI	G601-SF Supply Temperature	-40-60 °C	GD4-T GD3-BG
G605-TY	AO	G605-TV Position Output	0 – 100% (See Note 1)	GD4-T

1. Invert output such that 0% = Fully Open as the last step in setting analog output. All internal variables and the display should read 100% = Fully Open. All references in this document refer to 0% as closed.

4.10.2 HMI – PLC Interface

Discrete Status Bits:

Tagname	Description	Type	Display
G605_TV_CtrlMan	Control Mode Manual	R	GD4-F EF-T

Discrete Control Bits:

Tagname	Description	Type	Display
G605_TV_CtrlAutoCmd	Set to Auto Control Mode	W1	EF-PB (L)
G605_TV_CtrlManCmd	Set to Manual Control Mode	W1	EF-PB (L)

Analog Values:

Tagname	Description	Range	Type	Display
G605_TC_SP	Temperature Setpoint	-40-60°C	R	EF-T

 SNC-LAVALIN	FUNCTIONAL REQUIREMENTS SPECIFICATION - PLC		Document Code: 112577-0116-48ER-0001
			Revision: 00
Client: City of Winnipeg	Project: SEWPCC Ventilation Upgrades	Package / Area:	Wet Well and Grit Electrical & Blower Room Ventilation

Analog Set Points:

Tagname	Description	Range	Type	Display
G605_TC_SP_Unocc	Temperature Setpoint – Unoccupied	-40-60°C	RW	EF-TE (M)
G605_TC_SP_Occ	Temperature Setpoint - Occupied	-40-60°C	RW	EF-TE (M)
G605_TC_Man	Manual Position Output	0-100%	RW	EF-TE (L)

4.10.3 PLC Generated Alarms

Tagname	Description	Logic	Pri	Reset
G605_TAF	G605-TT Transmitter Fail	G605-TT < 4 mA or > 20 mA	3	Auto
G605-TAH	G601-SF Discharge Temperature High	NOT G605-TAF AND G605-TT > G605_TC_SP + 2°C for > 300 sec	3	Auto
G605-TAL	G601-SF Discharge Temperature Low	NOT G605-TAF AND G605-TT <= 2°C for > 60 sec	3	Auto

4.10.4 Interlocks

Initiating Event	Action	Control Mode		Display Interlock	Description
		Auto	Manual		
NOT (G605-MM)	G605-TC = 0	Y	N	N	Close Intake Valve when G605-GP is stopped

4.10.5 Control Narrative

Utilize PID control to control the hot water position valve, to achieve desired air temperature at G605-TT indicated by the temperature setpoint, G605_TC_SP.

PV: G605-TT

SP: G605_TC_SP

CV: G605-TC (Reverse Acting)

The position of the hot water control valve is based on the output of the temperature controller G605-TC. When the discharge temperature is below the setpoint, the supply temperature PID controller will open the control valve G605-TV to provide additional heating. Enable the PID loop only after G605-GP has started to prevent integral windup.

The setpoint will be dynamically switched between G605_TC_SP_Unocc and G605_TC_SP_Occ based upon occupancy (G606-YS).

 SNC-LAVALIN	FUNCTIONAL REQUIREMENTS SPECIFICATION - PLC		Document Code: 112577-0116-48ER-0001
			Revision 00
Client: City of Winnipeg	Project: SEWPCC Ventilation Upgrades	Package / Area: Wet Well and Grit Electrical & Blower Room Ventilation	

4.11 Wet Well Exhaust Fan G687-EF

P&ID Drawing: 1-0102G-A0095 PLC: PLC-G10

Exhaust Fan G687-EF provides exhaust ventilation to the wet well chamber. The speed of G687-EF is controlled by a VFD in order to maintain the wet well chamber air pressure at the setpoint. Under normal operations, G687-EF will be the only exhaust fan operating in the wet well chamber. The other exhaust fan, G686-EF, will operate as a backup fan, operating when G687-EF fails or during an emergency ventilation state.

4.11.1 PLC-I/O

Discrete:

Tag	Type	Description	0 State	1 State	Display
G687-UL	DI	G687-EF Starter Ready	Not Ready	Ready	GD3-F GD4-F
G687-YS	DI	G687-EF Auto Mode	Not Auto	Auto	GD3-F GD4-F
G687-MM	DI	G687-EF Running	Stopped	Running	GD3-A GD4-A
G687-MN	DO	G687-EF Run Command	Stop	Run	-
G687-ZSC	DI	Outlet Damper Closed	Not Closed	Closed	GD4-A
G687-ZSO	DI	Outlet Damper Fully Open	Not Fully Open	Fully Open	GD4-A

Analog:

Tag	Type	Description	Range	Display
G687-IT	AI	G687-EF Current Feedback (Amps)	0-10 A	EF-T
G687-SY	AO	G687-EF Speed Control	0-100%	

 SNC-LAVALIN	FUNCTIONAL REQUIREMENTS SPECIFICATION - PLC	Document Code: 112577-0116-48ER-0001
		Revision 00
Client: City of Winnipeg	Project: SEWPCC Ventilation Upgrades	Package / Area: Wet Well and Grit Electrical & Blower Room Ventilation

4.11.2 HMI – PLC Interface

Discrete Status Bits:

Tagname	Description	Type	Display
G687_CtrlMan	Control Mode Manual	R	GD3-F GD4-F EF-T
G687_Intlk	Interlocked	R	GD3-F GD4-F

Discrete Control Bits:

Tagname	Description	Type	Display
G687_CtrlAutoCmd	Set to Auto Control Mode	W1	EF-PB (L)
G687_CtrlManCmd	Set to Manual Control Mode	W1	EF-PB (L)
G687_Reset	Reset	W1	EF-PB (L)
G687_ManualStart	Manual Start Command	W1	EF-PB (L)
G687_ManualStop	Manual Stop Command	W1	EF-PB (L)
G687_KQ_Reset	Runtime Totalizer Reset	W1	EF-PB (L)

Analog Values:

Tagname	Description	Range	Type	Display
G687_KQI	Runtime	0 - 2 ³² -1 min	R	EF-T
G687_IT_FL A	Motor Current (FLA)	0-150%	R	GD4-T
G687_SI	Speed	0-100%	R	GD4-T

Analog Set Points:

Tagname	Description	Range	Type	Display
G687_SC_Man	Manual Speed Control Output	0-100%	RW	EF-TE (L)
G687_SC_Min	Minimum Speed Control Output	0-100%	RW	EF2-TE (H)
G687_SC_Init1	Initial Speed for Low Rate Ventilation	0-100%	RW	EF2-TE (H)
G687_SC_Init2	Initial Speed for High Rate Ventilation	0-100%	RW	EF2-TE (H)
G687_IAL_SP	Motor Current Low Alarm Setpoint	0-10 A	RW	EF2-TE (H)

 SNC-LAVALIN	FUNCTIONAL REQUIREMENTS SPECIFICATION - PLC		Document Code: 112577-0116-48ER-0001
			Revision: 00
Client: City of Winnipeg	Project: SEWPCC Ventilation Upgrades	Package / Area: Wet Well and Grit Electrical & Blower Room Ventilation	

4.11.3 PLC Generated Alarms

Tagname	Description	Logic	Pri	Reset
G687_RunFault	G687-EF Run Fault	NOT G551_ESL AND G687-YS AND ((G687-MM AND NOT(G687-MN) for 0.5 sec OR (G687-MN AND NOT G687-ZSC AND NOT G687-MM for 0.5 sec) Auto Reset on G551_ESL	2	Manual
G687-ZAO	G687-XV-Damper Open Fault	G687-YS AND G687-MN AND (G687-ZSC for 15 sec OR NOT G687-ZSO for 120 secs)	2	Auto
G687-ZAC	G687-XV-Damper Close Fault	G687-YS AND NOT G687-MN AND NOT G687-ZSC for 3 min	3	Auto
G687_IAL	G697-EF Motor Current Low	G687-IT < G687-IAL_SP for 10 secs	2	Auto

Generate common alarm G687_EF_Alm as a combination of the above.

4.11.4 Interlocks

Initiating Event	Action	Control Mode		Display Interlock	Description
		Auto	Manual		
G551_ESL	Stop	Y	Y	Y	Stop the pump on a MCC-1G power fail
NOT G687-UL OR NOT G687-YS	Stop	Y	Y	N	Turn off the Run Cmd output if the starter is not ready or in Auto.
G687_RunFault	Stop	Y	Y	N	Stop G687-EF if there is a Run Fault
G687-MM AND G687-ZSC	Stop	Y	Y	N	Stop if outlet damper closed
G501-AA	Run at full speed	Y	Y	Y	Run at full speed upon a gas alarm.
NOT G687-ZSO	Set to Minimum Speed	Y	N	N	Hold the fan at minimum speed until the damper is fully open.
NOT G601-MM AND NOT G602-MM	Set G687-EF to Minimum Speed	Y	N	Y	Set G687-EF to minimum speed if both supply fans have failed.

 SNC-LAVALIN	FUNCTIONAL REQUIREMENTS SPECIFICATION - PLC		Document Code: 112577-0116-48ER-0001
			Revision: 00
Client: City of Winnipeg	Project: SEWPCC Ventilation Upgrades	Package / Area:	Wet Well and Grit Electrical & Blower Room Ventilation

4.11.5 Control Narrative

In Auto mode, set the speed based upon G608-PC.

When in Auto mode, set the speed based upon the state of the Wet Well Ventilation Rate Controller, G6001-FC, changes, set the output immediately as follows, limited only by the rate limiter (described below).

State 0 (Off): Speed = 0

State 1 (Low): Speed = G687_SC_Init1 + 608_PC_CV

State 2 (High): Speed = G687_SC_Init2 + 608_PC_CV

State 3 (Emergency): Speed = 100

Utilize a rate limiter on the final output of the controller. The PID loop should be tuned slower than the rate limiter, which is utilized primarily for the discrete speed transitions. Tune the rate limiter during commissioning, but the initial value is expected to be approximately 3% per second. The rate limiter must be less than the maximum slew rate of the VFD.

Create a *Damper Opening* text animation on the equipment faceplate, that is active when G687-MN and NOT G687-ZSO.

4.12 Wet Well Pressure Controller G608-PC

P&ID Drawing: 1-0102G-A0093 PLC: PLC-G10

The pressure controller G608-PC adjusts the speed of exhaust fan G687-EF based upon the differential wet well pressure, as measured by G608-PT.

4.12.1 PLC-I/O

Analog:

Tag	Type	Description	Range	Display
G608-PDT	AI	Wet Well Differential Pressure	-250 – 250 Pa	GD3-BG GD4-T

4.12.2 HMI – PLC Interface

Discrete Status Bits:

Tagname	Description	Type	Display
G608_CtrlMan	Control Mode Manual	R	GD4-F EF-T

Discrete Control Bits:

Tagname	Description	Type	Display
G687_CtrlAutoCmd	Set to Auto Control Mode	W1	EF-PB (L)
G687_CtrlManCmd	Set to Manual Control Mode	W1	EF-PB (L)

 SNC-LAVALIN	FUNCTIONAL REQUIREMENTS SPECIFICATION - PLC	Document Code: 112577-0116-48ER-0001
		Revision: 00
Client: City of Winnipeg	Project: SEWPCC Ventilation Upgrades	Package / Area: Wet Well and Grit Electrical & Blower Room Ventilation

Analog Values:

Tagname	Description	Range	Type	Display
G608_PC_CV	Output Signal	-10% - 10%	R	EF-TE

Analog Set Points:

Tagname	Description	Range	Type	Display
G608_PC_SP	Pressure Differential Setpoint	-250 – 250 Pa	RW	EF-TE (M)

4.12.3 PLC Generated Alarms

Tagname	Description	Logic	Pri	Reset
G608-PAF	G608-PDT Transmitter Fail	G608-PDT < 4 mA or > 20 mA	3	Auto
G608-PAL	Wet Well Pressure Low	G608-PDT <= -50 Pa for 120 seconds	3	Auto
G608-PAH	Wet Well Pressure High	G608-PDT >= 50 Pa for 120 seconds	3	Auto

4.12.4 Control Narrative

When in Auto control mode, utilize PID control to control the adjustment to the speed of the fan G687-EF, to achieve desired pressure setpoint at G608-PDT:

PV: G608-PDT

SP: G608-PC_SP

CV: G608-CV (Reverse Acting)

Tune the PID controller with low gain, and mostly integral action. Controller should be tuned to act slowly, to avoid significant speed changes upon minor pressure changes such as the temporary opening of a door. Limit the output signal from (-10% to +10%) speed offset.

When the state of the Wet Well Ventilation Rate Controller, G6001-FC, changes, set the output as follows:

State 0 (Off): CV = 0

State 1 (Low): CV = 0 for 30 seconds, then enable PID

State 2 (High): CV = 0 for 30 seconds, then enable PID

State 3 (Emergency): CV = 0

Ensure that the controller tracks these transitions, to ensure that all transitions are bumpless.

Ensure the controller tracks when G687-EF is placed into manual control, and ensure transitions are bumpless.

Utilize a rate limiter on the final output of the controller. The PID loop should be tuned slower than the rate limiter, which is utilized primarily for the discrete speed transitions. Tune the rate limiter during commissioning, but the initial value is expected to be approximately 3% per second. The rate limiter must be less than the maximum slew rate of the VFD.

 SNC-LAVALIN	FUNCTIONAL REQUIREMENTS SPECIFICATION - PLC		Document Code: 112577-0116-48ER-0001
			Revision 00
Client: City of Winnipeg	Project: SEWPCC Ventilation Upgrades	Package / Area: Wet Well and Grit Electrical & Blower Room Ventilation	

4.13 Wet Well Lower Level Supply Fan, G602-FN

P&ID Drawing: 1-0102G-A0095 PLC: PLC-G10

G602-FN is a supply fan used to supply unheated outdoor air to the wet well lower level.

4.13.1 PLC-I/O

Discrete:

Tag	Type	Description	0 State	1 State	Display
G602-UL	DI	G602-SF Starter Ready	Not Ready	Ready	GD3-F GD4-F
G602-YS	DI	G602-SF Auto Mode	Not Auto	Auto	GD3-F GD4-F
G602-MM	DI	G602-SF Running	Stopped	Running	GD3-A GD4-A
G602-MN	DO	G602-SF Run Command	Stop	Run	-
G602-ZSC-1	DI	Inlet Damper Closed	Not Closed	Closed	GD4-A
G602-ZSO-1	DI	Inlet Damper Fully Open	Not Fully Open	Fully Open	GD4-A
G602-ZSC-2	DI	Outlet Damper Closed	Not Closed	Closed	GD4-A
G602-ZSO-2	DI	Outlet Damper Fully Open	Not Fully Open	Fully Open	GD4-A

Analog:

Tag	Type	Description	Range	Display
G602-SY	AO	G602-SF Speed Control	0-100%	GD4-T

4.13.2 HMI – PLC Interface

Discrete Status Bits:

Tagname	Description	Type	Display
G602_CtrlMan	Control Mode Manual	R	GD3-F GD4-F EF-T
G602_Intlk	Interlocked	R	GD3-F GD4-F

 SNC • LAVALIN	FUNCTIONAL REQUIREMENTS SPECIFICATION - PLC	Document Code: 112577-0116-48ER-0001
		Revision 00
Client: City of Winnipeg	Project: SEWPCC Ventilation Upgrades	Package / Area: Wet Well and Grit Electrical & Blower Room Ventilation

Discrete Control Bits:

Tagname	Description	Type	Display
G602_CtrlAutoCmd	Set to Auto Control Mode	W1	EF-PB (L)
G602_CtrlManCmd	Set to Manual Control Mode	W1	EF-PB (L)
G602_Reset	Reset	W1	EF-PB (L)
G602_ManualStart	Manual Start Command	W1	EF-PB (L)
G602_ManualStop	Manual Stop Command	W1	EF-PB (L)
G602_KQ_Reset	Runtime Totalizer Reset	W1	EF-PB (L)

Analog Values:

Tagname	Description	Range	Type	Display
G602_KQI	Runtime	0 - 2 ³² -1 min	R	EF-T

Analog Set Points:

Tagname	Description	Range	Type	Display
G602-SC-Man	Manual Speed Control Output	0-100%	RW	EF-TE (L)
G602-SC-Min	Minimum Speed Control Output	0-100%	RW	EF2-TE (H)
G602-SC-Low	Speed – Low Ventilation Rate	0-100%	RW	EF2-TE (H)
G602-SC-High	Speed – High Ventilation Rate	0-100%	RW	EF2-TE (H)
G602-SC-Emerg	Speed – Emerg Ventilation Rate	0-100%	RW	EF2-TE (H)

 SNC-LAVALIN	FUNCTIONAL REQUIREMENTS SPECIFICATION - PLC		Document Code: 112577-0116-48ER-0001
			Revision: 00
Client: City of Winnipeg	Project: SEWPCC Ventilation Upgrades	Package / Area: Wet Well and Grit Electrical & Blower Room Ventilation	

4.13.3 PLC Generated Alarms

Tagname	Description	Logic	Pri	Reset
G602_RunFault	G602-SF Run Fault	NOT G552_ESL AND G602-YS AND ((G602-MM AND NOT(G602-MN) for 0.5 sec OR (G602-MN AND NOT (G602-ZSC-1 OR G602-ZSC-2) AND NOT (G602-MM) for 0.5 sec) Auto Reset on G552_ESL	2	Manual
G602_PA	G602-SF Filter Plugged	G602-PDS for 10 sec. Auto reset if NOT G602-PDS for 30 secs	3	Auto
G602-ZAO-1	G602-XV-1 Damper Open Fault	G602-YS AND G602-MN AND (G602-ZSC-1 for 15 sec OR NOT G602-ZSO-1 for 120 secs)	2	Auto
G602-ZAC-1	G602-XV-1 Damper Close Fault	G601-YS AND NOT G602-MN AND NOT G602-ZSC-1 for 3 min	3	Auto
G602-ZAO-2	G602-XV-2 Damper Open Fault	G602-YS AND G602-MN AND (G602-ZSC-2 for 15 sec OR NOT G602-ZSO-2 for 120 secs)	2	Auto
G602-ZAC-2	G602-XV-2 Damper Close Fault	G601-YS AND NOT G602-MN AND NOT G602-ZSC-2 for 3 min	3	Auto

Generate common alarm G602_SF_Alm as a combination of the above.

4.13.4 Interlocks

Initiating Event	Action	Control Mode		Display Interlock	Description
		Auto	Manual		
G552_ESL	Stop	Y	Y	Y	Stop G602-SF on a MCC-2G power fail
NOT G602-UL OR NOT G602-YS	Stop	Y	Y	N	Turn off the Run Cmd output if the starter is not ready or not in Auto
NOT (G602-ZSO-1 AND G602-ZSO-2)	Set to Minimum Speed	Y	N	Y	Hold the fan at minimum speed until both dampers are fully open.
NOT (G686-MM OR G687-MM) for 0.5 seconds	Set to Minimum Speed	Y	N	Y	Initially, set G602-SF to minimum speed if exhaust fans have failed.
NOT (G686-MM OR G687-MM) for 15 seconds	Stop	Y	N	Y	Stop G602-SF if exhaust fans have failed
G602_RunFault	Stop	Y	Y	N	Stop G602-SF if there is a Run Fault
G602-MM AND (G602-ZCS-1 OR G602-ZSC-2)	Stop	Y	Y	N	Stop if either inlet or outlet dampers are closed

 SNC • LAVALIN	FUNCTIONAL REQUIREMENTS SPECIFICATION - PLC		Document Code: 112577-0116-48ER-0001
			Revision 00
Client: City of Winnipeg	Project: SEWPCC Ventilation Upgrades	Package / Area: Wet Well and Grit Electrical & Blower Room Ventilation	

Initiating Event	Action	Control Mode		Display Interlock	Description
		Auto	Manual		
G501-AA	Run at full speed	Y	Y	Y	Run at full speed upon a gas alarm.

4.13.5 Control Narrative

The speed of the fan is set by the state of the system ventilation controller, G602-State.

- 0 (Off) G602-SC=0
- 1 (Low) G602-SC= G602-SC-Low
- 2 (High) G602-SC= G602-SC-High
- 3 (Emergency) G602-SC= G602-SC-Emerg

Utilize a rate limiter to control the rate of the speed transitions. Set the value during commissioning, but it is expected that the rate will be approximately 3%/sec. Bypass the rate limiter on a transition to the off state.

Create a *Dampers Opening* text animation on the equipment faceplate, that is active when G602-MN AND NOT (G602-ZSO-1 AND G602-ZSO-2).

 SNC-LAVALIN	FUNCTIONAL REQUIREMENTS SPECIFICATION - PLC		Document Code: 112577-0116-48ER-0001
			Revision: 00
Client: City of Winnipeg	Project: SEWPCC Ventilation Upgrades	Package / Area: Wet Well and Grit Electrical & Blower Room Ventilation	

4.14 Flow Transmitter G602-FT

P&ID Drawing: 1-0102G-A0095 PLC: PLC-G10

G602-FT measures the flow of air discharged by supply fan G602-SF.

4.14.1 PLC-I/O

Discrete:

N/A

Analog:

Tag	Type	Description	Range	Display
G602-FT	AI	G602-SF Flow Transmitter	0-4000 l/s	-

4.14.2 HMI – PLC Interface

Analog Values:

Tagname	Description	Range	Type	Display
G602_FI	G602-SF Airflow (ACH)	0-14.98 ACH	R	GD3-BG GD4-T
G602_FI_2	G602-SF Airflow (L/s)	0-4000 l/s	R	GD4-T
G602_FI_SP	G602-SF Current Air Flow Setpoint	0-15 ACH	R	GD3-BGT EF-T
G602_FAL_SP	G602-SF Current Low Flow Alarm Setpoint	0-15 ACH	R	GD3-BGT EF-T
G602_FAH_SP	G602-SF Current High Flow Alarm Setpoint	0-15 ACH	R	GD3-BGT EF-T

Analog Set Points:

Tagname	Description	Range	Type	Display
G602_FAL_SPd	Low Flow Alarm Deviation Setpoint	0-15 ACH	RW	EF2-TE (H)
G602_FALL_SP	Low-Low Flow Alarm Setpoint	0-15 ACH	RW	EF2-TE (H) GD3-BGT
G602_FAH_SPd	High Flow Alarm Deviation Setpoint	0-15 ACH	RW	EF2-TE (H)
G602_FT_1_SP	Low Rate Setpoint	0-15 ACH	RW	EF2-TE (H)
G602_FT_2_SP	High Rate Setpoint	0-15 ACH	RW	EF2-TE (H)
G602_FT_3_SP	Emergency Rate Setpoint	0-15 ACH	RW	EF2-TE (H)

 SNC-LAVALIN	FUNCTIONAL REQUIREMENTS SPECIFICATION - PLC		Document Code: 112577-0116-48ER-0001
			Revision 00
Client: City of Winnipeg	Project: SEWPCC Ventilation Upgrades	Package / Area: Wet Well and Grit Electrical & Blower Room Ventilation	

4.14.3 PLC Generated Alarms

Tagname	Description	Logic	Pri	Reset
G602_FAF	G602-FT Transmitter Failure	G602-FT < 4 mA or > 20 mA	3	Auto
G602_FAL	G602-SF Low Flow	NOT G602-FAF AND G602-MM AND G602-FT <= G602_FAL_SP for > 60 secs	3	Auto
G602_FALL	G602-SF Low-Low Flow	NOT G602-FAF AND G602-MM AND G602-FT <= G602_FALL_SP for > 60 secs	2	Auto
G602_FAH	G602-SF High Flow	NOT G602-FAF AND G602-MM AND G602-FT >= G602_FAH_SP for > 60 secs	3	Auto

4.14.4 Interlocks

N/A

4.14.5 Control Narrative

Flow Transmitter G602-FT is used for monitoring and alarming only.

Set the current flow setpoint based upon the wet well Ventilation State Controller G6001-FC

Set G602_FAL_SP = G602_FT_SP - G602_FAL_SPd

Set G602_FAH_SP = G602_FT_SP - G602_FAH_SPd

 SNC-LAVALIN	FUNCTIONAL REQUIREMENTS SPECIFICATION - PLC	Document Code: 112577-0116-48ER-0001
		Revision 00
Client: City of Winnipeg	Project: SEWPCC Ventilation Upgrades	Package / Area: Wet Well and Grit Electrical & Blower Room Ventilation

4.15 Wet Well Exhaust Fan, G686-EF

P&ID Drawing: 1-0102G-A0095 PLC: PLC-G10

Exhaust Fan G686-EF acts as a backup and emergency exhaust fan for the wet well. G686-EF does not run during normal operations, however G686-EF runs when either G687-EF has failed or G6001-FC calls for emergency ventilation.

4.15.1 PLC-I/O

Discrete:

Tag	Type	Description	0 State	1 State	Display
G686-UL	DI	G686-EF Starter Ready	Not Ready	Ready	GD3-F GD4-F
G686-YS	DI	G686-EF Auto Mode	Not Auto	Auto	GD3-F GD4-F
G686-MM	DI	G686-EF Running	Stopped	Running	GD3-A GD4-A
G686-MN	DO	G686-EF Run Command	Stop	Run	-
G686-ZSC	DI	Outlet Damper Closed	Not Closed	Closed	GD4-A
G686-ZSO	DI	Outlet Damper Fully Open	Not Fully Open	Fully Open	GD4-A
G686-IS	DI	G686-EF Motor Loaded	Not Loaded	Loaded	-

4.15.2 HMI – PLC Interface

Discrete Status Bits:

Tagname	Description	Type	Display
G686_CtrlMan	Control Mode Manual	R	GD3-F GD4-F
G686_Intlk	Interlocked	R	GD3-F GD4-F

Discrete Control Bits:

Tagname	Description	Type	Display
G686_CtrlAutoCmd	Set to Auto Control Mode	W1	EF-PB (L)
G686_CtrlManCmd	Set to Manual Control Mode	W1	EF-PB (L)
G686_Reset	Reset	W1	EF-PB (L)

 SNC-LAVALIN	FUNCTIONAL REQUIREMENTS SPECIFICATION - PLC		Document Code: 112577-0116-48ER-0001
			Revision: 00
Client: City of Winnipeg	Project: SEWPCC Ventilation Upgrades	Package / Area: Wet Well and Grit Electrical & Blower Room Ventilation	

Tagname	Description	Type	Display
G686_ManualStart	Manual Start Command	W1	EF-PB (L)
G686_ManualStop	Manual Stop Command	W1	EF-PB (L)
G686_KQ_Reset	Runtime Totalizer Reset	W1	EF-PB (L)

Analog Values:

Tagname	Description	Range	Type	Display
G686_KQI	Runtime	0 - 2 ³² -1 min	R	EF-T

4.15.3 PLC Generated Alarms

Tagname	Description	Logic	Pri	Reset
G686_RunFault	G686-EF Run Fault	NOT G552_ESL AND G686-YS AND ((G686-MM AND NOT(G686-MN) for 0.5 sec OR (G686-MN AND NOT G686-ZSC AND NOT G686-MM for 0.5 sec) Auto Reset on G552_ESL	2	Manual
G686_ISL	G686-EF Motor Underload	G686-MM AND NOT G686-IS for 10 sec	2	Auto
G686-ZAO	G686-XV-Damper Open Fault	G686-YS AND G686-MN AND (G686-ZSC for 15 sec OR NOT G686-ZSO for 120 secs)	2	Auto
G686-ZAC	G686-XV-Damper Close Fault	G686-YS AND NOT G686-MN AND NOT G686-ZSC for 3 min	3	Auto

Generate common alarm G686_EF_Alm as a combination of the above.

4.15.4 Interlocks

Initiating Event	Action	Control Mode		Display Interlock	Description
		Auto	Manual		
G552_ESL	Stop	Y	Y	Y	Stop G686-EF on a MCC-2G power fail
NOT G686-UL OR NOT G686-YS	Stop	Y	Y	N	Turn off Run Cmd output if the starter is not ready or not in Auto
G686_RunFault	Stop	Y	Y	N	Stop G686-EF if there is a Run Fault
G686-MM AND NOT G686-ZCO	Stop	Y	Y	N	Stop if outlet damper not open
NOT G601-MM AND NOT G602-MM	Stop	Y	N	Y	Stop if both supply fans have failed.

 SNC-LAVALIN	FUNCTIONAL REQUIREMENTS SPECIFICATION - PLC		Document Code: 112577-0116-48ER-0001
			Revision 00
Client: City of Winnipeg	Project: SEWPCC Ventilation Upgrades	Package / Area:	Wet Well and Grit Electrical & Blower Room Ventilation

Initiating Event	Action	Control Mode		Display Interlock	Description
		Auto	Manual		
G501-AA	Run	Y	Y	Y	Run at full speed upon a gas alarm.

4.15.5 Control Narrative

When in Auto Mode, run G686-EF upon the following conditions:

- G687-EF OFF for 10 secs, or
- G6001-FC-State == 3 (Emergency)

If G6001_FC_State != 3 (Emergency) AND G687-MM then stop G686-EF.

Create a *Damper Opening* text animation on the equipment faceplate, that is active when G686-MN and NOT G686-ZSO.

 SNC-LAVALIN	FUNCTIONAL REQUIREMENTS SPECIFICATION - PLC		Document Code: 112577-0116-48ER-0001
			Revision 00
Client: City of Winnipeg	Project: SEWPCC Ventilation Upgrades	Package / Area: Wet Well and Grit Electrical & Blower Room Ventilation	

4.16 Miscellaneous

P&ID Drawing: 1-0102G-A0093 PLC: PLC-G10

The ventilation failure output is utilized to turn on the wet well gas detection horn and strobe, to warn personnel to exit the wet well.

4.16.1 PLC-I/O

Discrete:

Tag	Type	Description	0 State	1 State	Display
G606-YS	DI	Occupied Switch	Unoccupied	Occupied	GD2-T GD3-T
G606-YL-1	DO	"Do Not Enter" Lamp	Off	On	GD3-T
G606-YL-2	DO	"Enter" Lamp	Off	On	GD3-T
G607-QA	DO	Ventilation Failure (Turns on horn and strobe)	OK	Alarm	GD3-T

Analog:

N/A

4.16.2 HMI – PLC Interface

Analog Values:

N/A

4.16.3 PLC Generated Alarms

Tagname	Description	Logic	Pri	Reset
G606-KQA	Wet Well Occupied for > 8 Hours	G606-YS for > 8 hours	3	Auto

4.16.4 Control Narrative

Determine if the wet well is ventilated by timing if the system has been running for at least ten minutes. It does not necessarily have to be at high rate for ten minutes.

G606_Ventilated = (G601-MM AND G601-SY >= G601-SC_LOW AND NOT G601-FAL AND NOT G601_SF_Alm) FOR >= 600 sec AND
 (G602-MM AND G602-SY >= G602-SC_LOW AND NOT G602-FAL AND NOT G602_SF_Alm) FOR >= 600 sec AND
 ((G687-MM AND G687-SY >= G687-PC_Init1 AND NOT G687_EF_Alm) FOR >= 600 sec
 OR (G686-MM AND NOT G686_EF_Alm) FOR >= 600 sec)

 SNC-LAVALIN	FUNCTIONAL REQUIREMENTS SPECIFICATION - PLC	Document Code: 112577-0116-48ER-0001
		Revision 00
Client: City of Winnipeg	Project: SEWPCC Ventilation Upgrades	Package / Area: Wet Well and Grit Electrical & Blower Room Ventilation

Determine if the ventilation is acceptable for occupancy:

G606_VentOcc = NOT (

(NOT G601-MM OR G601_SF_Alm OR G601-SY < G601-SC_High OR G601_FAL) OR

(NOT G602-MM OR G602_SF_Alm OR G602-SY < G602-SC_High OR G602_FAL) OR

(NOT G687-MM OR G687_EF_Alm OR G687-SY < G687-PC_Init1))

Determine the state of the *Enter* lamp output as follows:

G606-YL-2 = G606-YS AND G606_Ventilated AND NOT G501-AA AND G606_VentOcc for 15 sec

The *Enter* lamp will turn on after 15 seconds of appropriate ventilation, provided that the wet well has been ventilated for ten minutes.

The *Do Not Enter* lamp will typically be opposite of the *Enter* lamp, however it will flash when the Wet Well switch indicates occupied (lights on), and waiting for the ventilation to ramp up or time out, to indicate to the operator to wait.

G606_WaitFlash = G606-YS and NOT G606-YL-2

Determine the state of the Ventilation Failure output. Only turn on if occupied or on a gas alarm.

G607-QA = G501-AA OR (G606-YS AND NOT G606_VentOcc for 60 seconds)

4.16.5 Alarms

(None)

 SNC-LAVALIN	FUNCTIONAL REQUIREMENTS SPECIFICATION - PLC		Document Code: 112577-0116-48ER-0001
			Revision: 00
Client: City of Winnipeg	Project: SEWPCC Ventilation Upgrades	Package / Area: Wet Well and Grit Electrical & Blower Room Ventilation	

4.17 LCP-G1 Monitoring

PLC: PLC-G10

4.17.1 PLC-I/O

Discrete:

Tag	Type	Description	0 State	1 State	Display
G901-EL-1	DI	LCP-G1 PS01 Power OK	Fail	OK	GD4-T
G901-EL-2	DI	LCP-G1 PS02 Power OK	Fail	OK	GD4-T

4.17.2 HMI - PLC Interface

Analog Values:

Tagname	Description	Range	Type	Display
G901_Heartbeat	PLC-G10 Heartbeat	0 - 32767	R	System Health

4.17.3 Alarms

Tagname	Description	Logic	Pri	Reset
G901_EA_1	LCP-G1 PS01 Power Supply Fail	NOT G901-EL-1 for 0.5 sec	3	Auto
G901_EA_2	LCP-G1 PS02 Power Supply Fail	NOT G901-EL-2 for 0.5 sec	3	Auto

4.17.4 Control Narrative

A heartbeat signal is to be implemented in the PLC so that remote devices can determine if the PLC is in Run mode (i.e. the RTU has not faulted).

Create a one second timer that increments a register, named "G901_Heartbeat", every one second. Increment the register to a set value (preferable 32767), reset to 0, and continue incrementing. This register will be monitored by the DCS.

 SNC-LAVALIN	FUNCTIONAL REQUIREMENTS SPECIFICATION - PLC		Document Code: 112577-0116-48ER-0001
			Revision: 00
Client: City of Winnipeg	Project: SEWPCC Ventilation Upgrades	Package / Area: Wet Well and Grit Electrical & Blower Room Ventilation	

4.18 Power Monitoring

PLC: PLC-G10

4.18.1 HMI - PLC Interface

Analog Values:

Read the following from the MCC-1G Power Meter via Modbus TCP at 10 second intervals:

IP Address: XXX.XXX.XXX.XXX Slave Node: X

Register	Tagname	Description	Range	Type	Display
4629	G551_ET	MCC-1G Voltage Average L-L	0 – 1,000 V	R	GD4-T

Read the following from the MCC-2G Power Meter via Modbus TCP at 10 second intervals:

IP Address: XXX.XXX.XXX.XXX Slave Node: X

Register	Tagname	Description	Range	Type	Display
4629	G552_ET	MCC-2G Voltage Average L-L	0 – 1,000 V	R	GD4-T

4.18.2 Alarms

Tagname	Description	Logic	Pri	Reset
G551_EAL	MCC-1G Power Failure	G551_ET < 540 V and NOT CommFail	3	Auto
G552_EAL	MCC-2G Power Failure	G552_ET < 540 V and NOT CommFail	3	Auto
MCC_1G_PM_CommFail	MCC-1G.PM Communication Failure	No communication for 30 seconds	3	Auto
MCC_2G_PM_CommFail	MCC-2G.PM Communication Failure	No communication for 30 seconds	3	Auto

 SNC-LAVALIN	FUNCTIONAL REQUIREMENTS SPECIFICATION - PLC	Document Code: 112577-0116-48ER-0001
		Revision: 00
Client: City of Winnipeg	Project: SEWPCC Ventilation Upgrades	Package / Area: Wet Well and Grit Electrical & Blower Room Ventilation

5.0 ELECTRICAL ROOM AND BLOWER ROOM

5.1 Control Narrative

The electrical room and blower room are ventilated by air handler G682-AHU, which will operate continuously. The outdoor air damper and return air damper are modulated to adjust the rate of outdoor air provided to the space. The system is designed to provide a minimum of 6 ACH of outdoor air to the space, however additional outdoor air is utilized to provide free cooling when required. The system has four states of operation:

- *Heat* – In the *Heat* state, the outdoor air damper is in the minimum position (6 ACH of outdoor air) and the heating coil is utilized to heat the air. The heating valve G682-TV-1 is modulated to provide the required level of heating to meet the setpoint.
- *Free Cool* – In the *Free Cool* state, the air handler utilizes additional outdoor air to provide cooling to the space. The outdoor air damper is modulated as required.
- *Free & Chill Cool* - In the *Free and Chill Cool* state, the air handler utilizes both outdoor air and the chill coil to provide cooling to the space. This state is utilized when the Free Cooling state cannot maintain the desired discharge air temperature setpoint. The outdoor air damper is opened fully, and the cooling valve G682-TV-2 is modulated to provide the additional cooling.
- *Chill Cool* – In the *Chill Cool* state, the air handler outdoor air damper is in the minimum position (6 ACH of outdoor air) and the cooling valve G682-TV-2 is modulated to provide the required level of cooling to meet the setpoint. The *Chill Cool* state is utilized when the outdoor air temperature exceeds a preset setpoint, where outdoor air cooling is not longer viable.

In addition to the above states, if the temperature in the electrical room exceeds a setpoint, exhaust fan G692-EF is turned on to discharge warm air from the electrical room near the VFDs, which are the most significant source of heat in the space. This reduces the cooling requirements on the air handler.

A pressure sensor, G682-PT is located within the electrical room to measure the differential pressure relative to ambient pressure. The relief air damper, G682-PV-3 is modulated to provide a positive pressure in the space of 50 Pa.

 SNC • LAVALIN	FUNCTIONAL REQUIREMENTS SPECIFICATION - PLC		Document Code: 112577-0116-48ER-0001
			Revision 00
Client: City of Winnipeg	Project: SEWPCC Ventilation Upgrades	Package / Area: Wet Well and Grit Electrical & Blower Room Ventilation	

5.2 Electrical Room AHU, G682-AHU

P&ID Drawing: 1-0102G-A0026 PLC: PLC-G11

G682-AHU supplies outside air to the Electrical Room and Boiler Room. G682-AHU is equipped with a heating coil system to provide heating in the winter and a cooling coil system to provide cooling during the summer

5.2.1 PLC-I/O

Discrete:

Tag	Type	Description	0 State	1 State	Display
G682-UL	DI	G682-AHU Starter Ready	Not Ready	Ready	GD3-F GD4-F
G682-YS	DI	G682-AHU Auto Mode	Not Auto	Auto	GD3-F GD4-F
G682-MM	DI	G682-AHU Running	Stopped	Running	GD3-A GD4-A
G682-FSL	DI	G682-AHU Flow Switch	No Flow	Flow	GD4-A
G682-TSL	DI	G682-AHU Low Temperature Switch	Low	Normal	GD4-A
G682-MN	DO	G682-AHU Run Command	Stop	Run	-

Analog:

Tag	Type	Description	Range	Display
G682-TT-1	AI	G682-AHU Outdoor Air Temperature	-40 - 40°C	GD4-T

5.2.2 HMI – PLC Interface

Discrete Status Bits:

Tagname	Description	Type	Display
G682_CtrlMan	Control Mode Manual	R	GD3-F GD4-F EF-T
G682_Intlk	Interlocked	R	GD3-F GD4-F

Discrete Control Bits:

Tagname	Description	Type	Display
---------	-------------	------	---------

 SNC-LAVALIN	FUNCTIONAL REQUIREMENTS SPECIFICATION - PLC		Document Code: 112577-0116-48ER-0001
			Revision: 00
Client: City of Winnipeg	Project: SEWPCC Ventilation Upgrades	Package / Area: Wet Well and Grit Electrical & Blower Room Ventilation	

G682_CtrlAutoCmd	Set to Auto Control Mode	W1	EF-PB (L)
G682_CtrlManCmd	Set to Manual Control Mode	W1	EF-PB (L)
G682_Reset	Reset	W1	EF-PB (L)
G682_ManualStart	Manual Start Command	W1	EF-PB (L)
G682_ManualStop	Manual Stop Command	W1	EF-PB (L)
G682_KQ_Reset	Runtime Totalizer Reset	W1	EF-PB (L)

Analog Values:

Tagname	Description	Range	Type	Display
G682_KQI	Runtime	0 - 2 ³² -1 min	R	EF-T

5.2.3 PLC Generated Alarms

Tagname	Description	Logic	Pri	Reset
G682_RunFault	G682-AHU Run Fault	NOT G552_ESL AND G682-YS AND ((G682-MM AND NOT G682-MN for 0.5 sec) OR (G682-MN AND NOT (G682-MM) for 0.5 sec)) Auto Reset on G552_ESL	2	Manual
G682_FAL	G682-AHU No Flow	G682-MM and NOT (G682-FSL) > 30 sec	2	Manual
G682_TAL	G682-AHU Freeze Alarm	G682-MM and NOT G682-TAL	2	Automatic

5.2.4 Interlocks

Initiating Event	Action	Control Mode		Display Interlock	Description
		Auto	Manual		
G552_ESL	Stop	Y	Y	Y	Stop G682-AHU on a MCC-2G Power Fail
NOT G682-UL OR NOT G682-YS	Stop	Y	Y	N	Turn off Run Cmd output if the starter is not ready or not in Auto
G682_RunFault	Stop	Y	Y	N	Stop G682-AHU if there is a Run Fault
G682_FAL	Stop	Y	N	N	Stop G682-AHU on a No Flow Alarm
G682_TAL	Stop	Y	Y	N	Stop G682-AHU on a Low Temperature Alarm

5.2.5 Control Narrative

G682-AHU supplies fresh air to the blower and electrical rooms. G682-AHU is to run at all times when in software Automatic mode. Restart automatically after a power failure.

 SNC-LAVALIN	FUNCTIONAL REQUIREMENTS SPECIFICATION - PLC	Document Code: 112577-0116-48ER-0001
		Revision 00
Client: City of Winnipeg	Project: SEWPCC Ventilation Upgrades	Package / Area: Wet Well and Grit Electrical & Blower Room Ventilation

5.3 G682-AHU Mixed Air Temperature Controller G682-TC-3

P&ID Drawing: 1-0102G-A0026 PLC: PLC-G11

G682-TC-3 is PLC-based temperature controller that maintains the return air temperature of G682-AHU at a desired temperature. G682-TT-3 is a temperature sensor located on the return air duct, and is representative of the average air temperature in the electrical and blower rooms. Note that it is expected that the actual electrical room temperature will be higher than the return air temperature, as the air from the blower room will likely be at a slightly lower temperature.

5.3.1 PLC I/O

Analog:

Tagname	Type	Description	Range	Display
G682-TT-3	AI	G682-AHU Return Air Temperature	0 - 50 °C	GD4-T

5.3.2 HMI - PLC Interface

Discrete Status Bits:

Tagname	Description	Type	Display
G682_TC_3_CtrlMan	Control Mode Manual	R	GD4-F EF-T

Discrete Control Bits:

Tagname	Description	Type	Display
G682_TC_3_CtrlAutoCmd	Set to Auto Control Mode	W1	EF-PB (L)
G682_TC_3_CtrlManCmd	Set to Manual Control Mode	W1	EF-PB (L)

Analog Set Points:

Tagname	Description	Range	Type	Control
G682_TC_3_SP	Return Air Temperature Setpoint	0 - 50°C	RW	EF-TE (M)
G682_TT_3_TAHH	High-High Temperature Alarm Setpoint	0 - 50°C	RW	EF2-TE (H)
G682_TT_3_TAH	High Temperature Alarm Setpoint	0 - 50°C	RW	EF2-TE (H)
G682_TT_3_TAL	Low Temperature Alarm Setpoint	0 - 50°C	RW	EF2-TE (H)
G682_TT_3_TALL	Low-Low Temperature Alarm Setpoint	0 - 50°C	RW	EF2-TE (H)
G682_TC_3_Man	Manual Discharge Temperature Output	0 - 50°C	RW	EF2-TE (L)

 SNC-LAVALIN	FUNCTIONAL REQUIREMENTS SPECIFICATION - PLC		Document Code: 112577-0116-48ER-0001
			Revision 00
Client: City of Winnipeg	Project: SEWPCC Ventilation Upgrades	Package / Area: Wet Well and Grit Electrical & Blower Room Ventilation	

5.3.3 PLC Generated Alarms

Tagname	Description	Logic	Pri	Reset
G682_TT-3_F	G682-TT-3 Fail	G682-TT-2 < 4mA or > 20mA	3	Auto
G682_TT_3_TAHH	G682-AHU Return Air Temperature High-High	NOT G682_TAF AND G682-TT-3 => G682-TT-3_TAHH for > 1 minute	3	Auto
G682_TT_3_TAH	G682-AHU Return Air Temperature High	NOT G682_TAF AND G682_TT-3 >= G682-TT-3_TAH for > 1 minute	3	Auto
G682_TT_3_TAL	G682-AHU Return Air Temperature Low	NOT G682_TAF AND G682_TT-3 <= G682-TT-3_TAL for > 1 minute	3	Auto
G682_TT_3_TALL	G682-AHU Return Air Temperature Low-Low	NOT G682_TAF AND G682-TT-2 <= G682-TT-3_TALL for > 1 minute	3	Auto

5.3.4 Control Narrative

Utilize PID control to control the discharge temperature controller (G682-TC-2) based upon the return air temperature:

PV: G682-TT-3

SP: G682_TC_3_SP

CV: G682_TC_2_SP (Reverse Acting)

The setpoint of the Discharge Air Temperature Controller G682-TC-2 is based on the output of the Return Air Temperature Controller G682-TC-3. As the room temperature cools, G682-TC-3 will bump up the air handler discharge temperature setpoint, and vice-versa. Ensure bump-less transfer is provided between manual and automatic modes.

 SNC-LAVALIN	FUNCTIONAL REQUIREMENTS SPECIFICATION - PLC		Document Code: 112577-0116-48ER-0001
			Revision: 00
Client: City of Winnipeg	Project: SEWPCC Ventilation Upgrades	Package / Area: Wet Well and Grit Electrical & Blower Room Ventilation	

5.4 G682-AHU Discharge Air Temperature Controller G682-TC-2

P&ID Drawing: 1-0102G-A0026 PLC: PLC-G11

G682-TC-2 is an internal temperature controller that maintains the supply air temperature of G682-AHU at a desired temperature. G682-TT-2 is a temperature sensor used to monitor the temperature of the air being supplied to the Electrical Room and Blower Room. The setpoint for the discharge air temperature is typically controlled by the internal return air temperature controller G682-TC-3.

5.4.1 PLC I/O

Analog:

Tagname	Type	Description	Range	Display
G682-TT-2	AI	G682-AHU Supply Air Temperature	-40 - 40 °C	GD4-T

5.4.2 HMI - PLC Interface

Discrete Status Bits:

Tagname	Description	Type	Display
G682-TC_2_CtrlMan	Control Mode Manual	R	GD4-F EF-T

Discrete Control Bits:

Tagname	Description	Type	Display
G682-TC_2_CtrlAutoCmd	Set to Auto Control Mode	W1	EF-PB (L)
G682-TC_2_CtrlManCmd	Set to Manual Control Mode	W1	EF-PB (L)

Analog Values:

Tagname	Description	Range	Type	Display
G682-TC_2_ChillCV	Chilling Control Output	0 – 100%	R	EF-T
G682-TC_2_FreeCV	Free Cooling Control Output	0 – 100%	R	EF-T
G682-TC_2_HeatCV	Heating Control Output	0 – 100%	R	EF-T
G682-TC_2_SP	Discharge Temperature Setpoint (copy of G682-TC-3_CV)	-40-40°C	R	EF-T
G682-TC_2_State	State	1-4	R	GD4-T

States:

- 1 – Heat
- 2 – Free Cool
- 3 – Free & Chill Cool
- 4 – Chill Cool

 SNC-LAVALIN	FUNCTIONAL REQUIREMENTS SPECIFICATION - PLC		Document Code: 112577-0116-48ER-0001
			Revision 00
Client: City of Winnipeg	Project: SEWPCC Ventilation Upgrades	Package / Area: Wet Well and Grit Electrical & Blower Room Ventilation	

Analog Set Points:

Tagname	Description	Range	Type	Control
G682_TC_2_TDAH_SP	High Temperature Alarm Delta Setpoint	0 - 50°C	RW	EF2-TE (M)
G682_TC_2_TDAL_SP	Low Temperature Alarm Delta Setpoint	0 - 50°C	RW	EF2-TE (M)
G682_TC_2_FreeCoolMaxT	Maximum Temperature for Free Cooling	0 - 50°C	RW	EF2-TE (M)
G682_TC_2_ManState	Manual State	1-4 0 = no cmd	W1	EF-PB (L)

Notes: The Delta alarms are based upon the current temperature setpoint.

The PLC will reset the ManState variable to 0 after transferring the value to the State variable, when in Manual mode.

5.4.3 PLC Generated Alarms

Tagname	Description	Logic	Pri	Reset
G682_TAF	G682-TT-2 Failure	G682-TT-2 < 4mA or > 20mA	3	Auto
G682_TAHH	G682-AHU Supply Temperature High-High	NOT G682_TAF AND G682-TT-2 => 38°C for > 10 sec	2	Auto
G682_TC_2_TDAH	G682-AHU Supply Air Temperature High	NOT G682_TAF AND (G682_TT_02 - G682-TC-2_SP) >= G682-TC-2_TDAH_SP for > 1 minute	3	Auto
G682_TC_2_TDAL	G682-AHU Supply Air Temperature Low	NOT G682_TAF AND (G682-TC-2_SP - G682_TT_02) >= G682-TC-2_TDAL_SP for > 1 minute	3	Auto
G682_TALL	G682-AHU Supply Temperature Low-Low	NOT G682_TAF AND G682-TT-2 <= 3°C for > 10 sec	3	Auto

 SNC-LAVALIN	FUNCTIONAL REQUIREMENTS SPECIFICATION - PLC	Document Code: 112577-0116-48ER-0001
		Revision: 00
Client: City of Winnipeg	Project: SEWPCC Ventilation Upgrades	Package / Area: Wet Well and Grit Electrical & Blower Room Ventilation

5.4.4 Control Narrative

The state will transition between the state as follows:

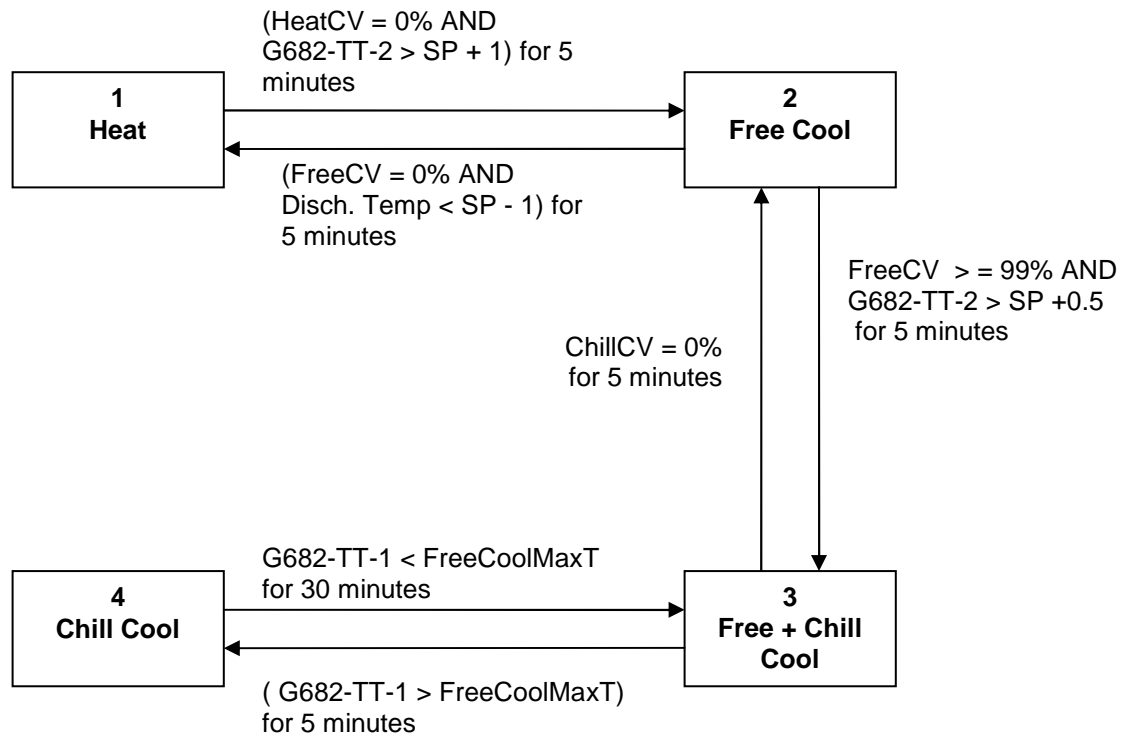

Figure 5 : G682-TC-2 State Diagram

The temperature control will be provided by three independently tuned PID control loops. Ensure that all transitions are bumpless. If the state is ever out of range (<1 or > 4) then set State = 1 (Heat). The control strategy for each state is as follows:

State 1 – Heat

Control the heating valve based on PID control:

PV: G682-TT-2
 SP: G682_TC_2_SP
 CV: G682_HeatCV (Reverse Acting)

CV_Limits: Low: 0%
 High: 100%

FreeCV = 0% (Note: Minimum fresh air requirements still apply)

ChillCV = 0%

 SNC-LAVALIN	FUNCTIONAL REQUIREMENTS SPECIFICATION - PLC	Document Code: 112577-0116-48ER-0001
		Revision 00
Client: City of Winnipeg	Project: SEWPCC Ventilation Upgrades	Package / Area: Wet Well and Grit Electrical & Blower Room Ventilation

State 2 – Free Cool

Control the mixed air dampers based on PID control:

PV: G682-TT-2
 SP: G682_TC_2_SP
 CV: G682_FreeCV (Forward Acting)

CV_Limits: Low: 0%
 High: 100%

(Note: the limit for minimum damper position is handled by the damper control)

HeatCV = 0%

ChillCV = 0%

State 3 – Free + Chill Cool

In this state, the mixed air dampers are positioned for maximum outdoor air cooling in addition to chiller cooling.

Control the chilled water valve based on PID control:

PV: G682-TT-2
 SP: G682_TC_2_SP
 CV: G682_ChillCV (Forward Acting)

CV_Limits: Low: 0%
 High: 100%

HeatCV = 0%

FreeCV = 100%

State 4 –Chill Cool

In this state, the mixed air dampers are closed to the minimum position as the outdoor air is too warm for efficient cooling. The PID control block is the same as for State 3.

Control the chilled water valve based on PID control:

PV: G682-TT-2
 SP: G682_TC_2_SP
 CV: G682_ChillCV (Forward Acting)

CV_Limits: Low: 0%
 High: 100%

HeatCV = 0%

FreeCV = 0% (Note: Minimum fresh air requirements still apply and will be applied by the damper control)

 SNC-LAVALIN	FUNCTIONAL REQUIREMENTS SPECIFICATION - PLC		Document Code: 112577-0116-48ER-0001
			Revision: 00
Client: City of Winnipeg	Project: SEWPCC Ventilation Upgrades	Package / Area: Wet Well and Grit Electrical & Blower Room Ventilation	

5.5 G682-AHU Heating Valve G682-TV-1

P&ID Drawing: 1-0102G-A0026 PLC: PLC-G11

G682-TV-1 is a modulating valve which provides heating control for the Electrical and Boiler Rooms. The valve is controlled by a PID loop to maintain the setpoint temperature at G682-TT-2 in the winter.

5.5.1 PLC-I/O

Analog:

Tag	Type	Description	Range	Display
G682-TY-1	AO	G682-TV-1 Output Signal	0 – 100% (See Note 1)	GD4-T

1. Invert output such that 0% = Fully Open as the last step in setting analog output. All internal variables and the display should read 100% = Fully Open. All references in this document refer to 0% as closed.

5.5.2 HMI – PLC Interface

Discrete Status Bits:

Tagname	Description	Type	Display
G682_TV_1_CtrlMan	Control Mode Manual	R	GD4-F EF-T

Discrete Control Bits:

Tagname	Description	Type	Display
G682_TV_1_CtrlAutoCmd	Set to Auto Control Mode	W1	EF-PB (L)
G682_TV_1_CtrlManCmd	Set to Manual Control Mode	W1	EF-PB (L)

Analog Values:

Tagname	Description	Range	Type	Display
G682_TV_1_ZI	Position	0 – 100%	R	GD4-T

Analog Set Points:

Tagname	Description	Range	Type	Display
G682_TV_1_Man	Manual Position Output	0-100%	RW	EF-TE (L)

 SNC-LAVALIN	FUNCTIONAL REQUIREMENTS SPECIFICATION - PLC		Document Code: 112577-0116-48ER-0001
			Revision: 00
Client: City of Winnipeg	Project: SEWPCC Ventilation Upgrades	Package / Area:	Wet Well and Grit Electrical & Blower Room Ventilation

5.5.3 PLC Generated Alarms

None.

5.5.4 Interlocks

Initiating Event	Action	Control Mode		Display Interlock	Description
		Auto	Manual		
NOT (G682-MM)	G682-TY-1 = 0	Y	N	N	Close Valve when G682-AHU is stopped

5.5.5 Control Narrative

Set ZI = G682_TY_1 (commanded position)

When in Auto mode, set the position of the valve based upon G682_TC-2.HeatCV

Ensure bump-less transfer is provided between manual and automatic modes.

 SNC-LAVALIN	FUNCTIONAL REQUIREMENTS SPECIFICATION - PLC		Document Code: 112577-0116-48ER-0001
			Revision 00
Client: City of Winnipeg	Project: SEWPCC Ventilation Upgrades	Package / Area: Wet Well and Grit Electrical & Blower Room Ventilation	

5.6 G682-AHU Cooling Valve G682-TV-2

P&ID Drawing: 1-0102G-A0026 PLC: PLC-G11

G682-TV-2 is a modulating valve in the cooling control system of the Electrical and Boiler Room. The valve is located on the water return line and is controlled by a PID loop to maintain the setpoint temperature at G682-TT-2.

5.6.1 PLC-I/O

Analog:

Tag	Type	Description	Range	Display
G682-TV-2	AO	G682-TV-2 Output Signal	0 – 100%	GD4-T

5.6.2 HMI – PLC Interface

Discrete Status Bits:

Tagname	Description	Type	Display
G682_TV_2_CtrlMan	Control Mode Manual	R	GD4-F EF-T

Discrete Control Bits:

Tagname	Description	Type	Display
G682_TV_2_CtrlAutoCmd	Set to Auto Control Mode	W1	EF-PB (L)
G682_TV_2_CtrlManCmd	Set to Manual Control Mode	W1	EF-PB (L)

Analog Values:

Tagname	Description	Range	Type	Display
G682_TV_2_ZI	Position	0 – 100%	R	GD4-T

Analog Set Points:

Tagname	Description	Range	Type	Display
G682_TV_2_Man	Manual Position Output	0-100%	RW	EF-TE (L)

5.6.3 PLC Generated Alarms

None

 SNC-LAVALIN	FUNCTIONAL REQUIREMENTS SPECIFICATION - PLC		Document Code: 112577-0116-48ER-0001
			Revision 00
Client: City of Winnipeg	Project: SEWPCC Ventilation Upgrades	Package / Area: Wet Well and Grit Electrical & Blower Room Ventilation	

5.6.4 Interlocks

Initiating Event	Action	Control Mode		Display Interlock	Description
		Auto	Manual		
NOT (G682-MM)	G682-TY-2= 0	Y	N	N	Close Valve when G682-AHU is stopped

5.6.5 Control Narrative

Set ZI = G682-TY-2 (commanded position)

When in Auto mode, set the position of the valve based upon G682_TC-2.ChillCV

Ensure bump-less transfer is provided between manual and automatic modes.

 SNC-LAVALIN	FUNCTIONAL REQUIREMENTS SPECIFICATION - PLC		Document Code: 112577-0116-48ER-0001
			Revision: 00
Client: City of Winnipeg	Project: SEWPCC Ventilation Upgrades	Package / Area: Wet Well and Grit Electrical & Blower Room Ventilation	

5.7 Mixed Air Dampers – G682-FV-1, G682-FV-2

P&ID Drawing: 1-0102G-A0026 PLC: PLC-G11

Dampers G682-FV-1 and G682-FV-2 are utilized to control the mixed air ratio to the air handling unit G682-AHU. The dampers allow for a fresh air ratio of between 40 – 100%, to meet temperature requirements. The damper position correlating to 40% fresh air flow should be tested at commissioning, and entered as a setting.

5.7.1 PLC I/O

Discrete:

None

Analog:

Tag	Type	Description	Range	Display
G682-FY-1	AO	Intake and Return Air Damper Control (See Note 1)	0 – 100%	GD4-T
G682-ZT-1	AI	Intake Air Damper Position Feedback	0 – 100% Open	GD4-T
G682-ZT-2	AI	Return Air Damper Position Feedback	0 – 100% Open	GD4-T

Notes:

1. An output of 0% for G682-FY-1 will close the intake and open the return air damper.

5.7.2 HMI - PLC Interface

Discrete Status Bits:

Tagname	Description	Type	Display
G682_FV_1_CtrlMan	Control Mode Manual	RW	GD4-F EF-T

Discrete Control Bits:

Tagname	Description	Type	Control
G682_FV_1_CtrlAutoCmd	Set to Auto Control Mode	W1	EF-PB (L)
G682_FV_1_CtrlManCmd	Set to Manual Control Mode	W1	EF-PB (L)

Analog Values:

Tagname	Description	Range	Type	Display
G682_FV_1_ZI	Intake Air Damper Position	0 – 100%	R	GD4-T
G682_FV_2_ZI	Return Air Damper Position	0 – 100%	R	GD4-T

 SNC-LAVALIN	FUNCTIONAL REQUIREMENTS SPECIFICATION - PLC		Document Code: 112577-0116-48ER-0001
			Revision 00
Client: City of Winnipeg	Project: SEWPCC Ventilation Upgrades	Package / Area:	Wet Well and Grit Electrical & Blower Room Ventilation

Analog Set Points:

Tagname	Description	Range	Type	Control
G682_FV_1_Manual	Manual Mode Output	0 – 100 %	RW	EF-TE (L)
G682_FV_1_MinA	Min Outdoor Operating Damper Position with G692-EF off (Determine value during commissioning – should correspond to 40% Outdoor Air)	0 – 100 %	RW	EF2-TE (H)
GG82-FV_1_MinB	Min Outdoor Operating Damper Position with G692-EF on (Determine value during commissioning – should correspond to 40% Outdoor Air)	0 – 100 %	RW	EF2-TE (H)

5.7.3 PLC Generated Alarms

Tagname	Description	Logic	Pri	Reset
G682_ZT_1_F	G682-FV-1 Fail	G682-ZT-1 < 4mA or > 20 mA	3	Auto
G682_ZT_2_F	G682-FV-2 Fail	G682-ZT-2 < 4mA or > 20 mA	3	Auto
G682_FV_1_ZA	G682-FV-1 Not In Position	ABS(G682-FY-1 – G682_ZT_01) > 10% for > 150 seconds (Note 1)	3	Auto
G682_FV_2_ZA	G682-FV-2 Not In Position	ABS(G682-FY-1- (100% - L601_ZT_02)) > 10% for > 150 seconds (Note 1)	3	Auto

Notes:

(1) Position command and position feedback are in units of percent (%).

5.7.4 Interlocks

Initiating Event	Action	Control Mode		Display Interlock	Description
		Auto	Manual		
NOT G682_MM	Set G682_FY_1 = 0 %	Y	N	N	Close Intake Damper when G682-AHU Supply Fan is stopped
G682_TAL	Set G682-FY-1 = G682_FV_1_MinA if G692-EF is OFF Set G682-FY-1 = G682_FV_1_MinB if G692-EF is ON	Y	N	N	Close intake damper to the minimum position when there is a low supply temperature alarm.
G682_TALL	Set G682-FY-1 = 0 %	Y	N	N	Close Intake Damper fully when there is a discharge low-low temperature alarm to prevent freezing.

 SNC-LAVALIN	FUNCTIONAL REQUIREMENTS SPECIFICATION - PLC	Document Code: 112577-0116-48ER-0001
		Revision 00
Client: City of Winnipeg	Project: SEWPCC Ventilation Upgrades	Package / Area: Wet Well and Grit Electrical & Blower Room Ventilation

5.7.5 Control Narrative

When in Auto mode, control the position of the dampers based upon the discharge air temperature controller, G682_TC_2.FreeCV. The FreeCV variable is scaled 0 – 100%, and thus must be rescaled to match the controllable range for the dampers. The controllable range is dependent upon whether the exhaust fan G692-EF is running.

G692-MM == 0:

Control Range = G682_FV_1_MinA to 100%

G692-MM == 1:

Control Range = G682_FV_1_MinB to 100%

 SNC · LAVALIN	FUNCTIONAL REQUIREMENTS SPECIFICATION - PLC		Document Code: 112577-0116-48ER-0001
			Revision 00
Client: City of Winnipeg	Project: SEWPCC Ventilation Upgrades	Package / Area: Wet Well and Grit Electrical & Blower Room Ventilation	

5.8 Pressure Controller G682-PC

P&ID Drawing: 1-0102G-A0026 PLC: PLC-G11

Pressure Controller G682-PC is an internal PID controller that maintains the pressure of the electrical room at a setpoint. The design setpoint for the space is +25 Pa relative to atmospheric pressure. The output of the pressure controller is utilized to drive the relief air damper. It should also be noted that pressure control is also indirectly provided for the blower room.

5.8.1 PLC I/O

Discrete:

None

Analog:

Tag	Type	Description	Range	Display
G682-PDT	AI	Grit Electrical Room Differential Pressure	-100 – 100 Pa	GD4-T

5.8.2 HMI - PLC Interface

Analog Set Points:

Tagname	Description	Range	Type	Control
G682_PC_SP	Pressure Setpoint	-100 – 100 Pa	RW	EF-TE (H)
G682_PC_SF_Start	Output on Supply Fan Startup	0 – 100 %	RW	EF-TE (H)
G682_PC_EF_Start	Output on Exhaust Fan Startup	0 – 100 %	RW	EF-TE (H)

5.8.3 PLC Generated Alarms

Tagname	Description	Logic	Pri	Reset
G682_PAF	G682-PDT Transmitter Fail	G682-PDT < 4mA or > 20 mA	3	Auto
G682_PAL	Grit Electrical Room Differential Pressure Low	G682-PDT <= 0 Pa for 240 seconds	3	Auto
G682_PAH	Grit Electrical Room Differential Pressure High	G682-PDT >= 50 Pa for 240 seconds	3	Auto

5.8.4 Interlocks

Initiating Event	Action	Control Mode		Display Interlock	Description
		Auto	Manual		
NOT G682_MM	Set G682_PC_CV = 0%	Y	N	N	Close Relief Damper when G682-AHU Supply Fan is stopped

 SNC-LAVALIN	FUNCTIONAL REQUIREMENTS SPECIFICATION - PLC		Document Code: 112577-0116-48ER-0001
			Revision: 00
Client: City of Winnipeg	Project: SEWPCC Ventilation Upgrades	Package / Area: Wet Well and Grit Electrical & Blower Room Ventilation	

5.8.5 Control Narrative

When in auto mode, utilize PID control to control the position of damper G682-PV-3.

Upon G682-AHU fan startup, set the output to G682_PC_SF_Start until the damper is \leq 5% of the desired position, plus 15 seconds. After this, allow the PID controller to take over.

PV: G682-PDT
 SP: G682_PC_SP
 CV: G682_PC_CV (Reverse Acting)

CV_Limits: Low: 0%
 High: 100%

The PID controller will be tuned fairly slow, with mostly integral action, to prevent brief pressure changes such as door opening from affecting the control.

Upon G692-EF startup (and if G682-AHU is running), temporarily disable PID control and set the output to G682_PC_EF_Start until the damper is \leq 5% of the desired position, plus 15 seconds. After this, allow the PID controller to take over.

Upon G692-EF stopping (and if G682-AHU is running), temporarily disable PID control and set the output to G682_PC_SF_Start until the damper is \leq 5% of the desired position, plus 15 seconds. After this, allow the PID controller to take over.

Ensure all transitions are bumpless, including any auto / manual transitions for G682-PV-3. When the damper is in manual mode, the pressure controller output should be set to follow.

 SNC-LAVALIN	FUNCTIONAL REQUIREMENTS SPECIFICATION - PLC		Document Code: 112577-0116-48ER-0001
			Revision 00
Client: City of Winnipeg	Project: SEWPCC Ventilation Upgrades	Package / Area: Wet Well and Grit Electrical & Blower Room Ventilation	

5.9 Relief Air Damper G682-PV-3

P&ID Drawing: 1-0102G-A0026 PLC: PLC-G11

Damper G682-PV-3 is utilized to provide pressure control for the electrical room. It indirectly also provides pressure control for the blower room.

5.9.1 PLC I/O

Analog:

Tag	Type	Description	Range	Display
G682-PY-3	AO	G682-AHU Relief Air Damper Output Signal	0 – 100%	GD4-T
G682-ZT-3	AI	G682-AHU Relief Air Damper Position Feedback	0 – 100% Open	GD4-T

5.9.2 HMI - PLC Interface

Discrete Status Bits:

Tagname	Description	Type	Display
L682_PV_3_CtrlMan	Control Mode Manual	RW	GD4-F EF-T

Discrete Control Bits:

Tagname	Description	Type	Control
G682_PV_3_CtrlAutoCmd	Set to Auto Control Mode	W1	EF-PB (L)
G682_PV-3_CtrlManCmd	Set to Manual Control Mode	W1	EF-PB (L)

Analog Set Points:

Tagname	Description	Range	Type	Control
G682_PV_3_Manual	Manual Mode Output	0 – 100 %	RW	EF-TE (L)

5.9.3 PLC Generated Alarms

Tagname	Description	Logic	Pri	Reset
G682_PV_3_F	G682-PV-3 Fail	G682-ZT-3 < 4mA or > 20 mA	3	Auto
G682_PV_3_ZA	G682-AHU Relief Air Damper Not In Position	ABS(G682_PY_3 – G682-ZT-3) > 5% for > 150 seconds	3	Auto

5.9.4 Control Narrative

When in auto mode, utilize the output of G682-PC to set the position of the damper.

 SNC-LAVALIN	FUNCTIONAL REQUIREMENTS SPECIFICATION - PLC		Document Code: 112577-0116-48ER-0001
			Revision: 00
Client: City of Winnipeg	Project: SEWPCC Ventilation Upgrades	Package / Area: Wet Well and Grit Electrical & Blower Room Ventilation	

5.10 Grit Electrical Room Temperature, G692-TT

PID Drawing: 1-0102G-A0096 PLC: PLC-G11

G692-TT measures the electrical room temperature near the VFDs, which should normally be the warmest location within the electrical room.

5.10.1 PLC-I/O

5.10.2 Analog:

Tag	Type	Description	Range	Display
G692-TT	AI	Grit Electrical Room Temperature – VFD Area	0 – 50 °C	GD4-T

5.10.3 HMI - PLC Interface

Analog Set Points:

Tagname	Description	Range	Type	Control
G692_TT_TAH_SP	High Temperature Setpoint	0 – 50 °C	RW	EF-TE (M)

5.10.4 PLC Generated Alarms

Tagname	Description	Logic	Pri	Reset
G692_TT_F	G692-TT Electrical Room Temperature Fail	G692-TT < 4mA or > 20mA	3	Auto
G692_TT_TAL	Grit Electrical Room Low Temperature	NOT G692_TT_F AND G692-TT <= 4°C for 2 minutes	3	Auto
G692_TT_TAH	Grit Electrical Room High Temperature	NOT G692_TT_F AND G692-TT >= G692-TT_TAH_SP for 2 minutes	2	Auto

5.10.5 Interlocks

N/A

5.10.6 Control Narrative

N/A

 SNC-LAVALIN	FUNCTIONAL REQUIREMENTS SPECIFICATION - PLC		Document Code: 112577-0116-48ER-0001
			Revision 00
Client: City of Winnipeg	Project: SEWPCC Ventilation Upgrades	Package / Area: Wet Well and Grit Electrical & Blower Room Ventilation	

5.11 Grit Electrical Room Exhaust Fan, G692-EF

PID Drawing: 1-0102G-A0096 PLC: PLC-G11

G692-EF discharges air from the electrical room near the VFDs. As this is the warmest location within the electrical room, it prevents this warm air from being returned to the air handler. It is turned on when the temperature in the electrical room exceeds a setpoint.

5.11.1 PLC-I/O

Discrete:

Tag	Type	Description	0 State	1 State	Display
G692-UL	DI	G692-EF Starter Ready	Not Ready	Ready	GD4-T
G692-YS	DI	G692-EF Auto Mode	Not Auto	Auto	GD4-T
G692-MM	DI	G692-EF Running	Stopped	Running	GD4-A
G692-ZSC	DI	Outlet Damper Closed	Not Closed	Closed	GD4-A
G692-ZSO	DI	Outlet Damper Fully Open	Not Fully Open	Fully Open	GD4-A
G692-MN	DO	G692-EF Run Command	Stop	Run	-

5.11.2 Analog:

N/A

5.11.3 HMI – PLC Interface

Discrete Status Bits:

Tagname	Description	Type	Display
G692_CtrlMan	Control Mode Manual	R	GD4-F EF-T
G692_Intlk	Interlocked	R	GD4-F

 SNC-LAVALIN	FUNCTIONAL REQUIREMENTS SPECIFICATION - PLC	Document Code: 112577-0116-48ER-0001
		Revision 00
Client: City of Winnipeg	Project: SEWPCC Ventilation Upgrades	Package / Area: Wet Well and Grit Electrical & Blower Room Ventilation

Discrete Control Bits:

Tagname	Description	Type	Display
G692_CtrlAutoCmd	Set to Auto Control Mode	W1	EF-PB (L)
G692_CtrlManCmd	Set to Manual Control Mode	W1	EF-PB (L)
G692_Reset	Reset	W1	EF-PB (L)
G692_ManualStart	Manual Start Command	W1	EF-PB (L)
G692_ManualStop	Manual Stop Command	W1	EF-PB (L)
G682_KQ_Reset	Runtime Totalizer Reset	W1	EF-PB (L)

Analog Values:

Tagname	Description	Range	Type	Display
G692_KQI	Runtime	0 - 2 ³² -1 min	R	EF-T

Analog Set Points:

Tagname	Description	Range	Type	Display
G692_StartSP	G692-EF Fan Start Temperature Setpoint	0-50 °C	RW	EF-TE (M)

5.11.4 PLC Generated Alarms

Tagname	Description	Logic	Pri	Reset
G692_RunFault	G692-EF Run Fault	NOT G552_ESL AND G692-YS AND ((G692-MM AND NOT(G692-MN) for 0.5 sec OR (G692-MN AND NOT (G692-MM) AND G692-ZSO for 0.5 sec) Auto Reset on G552_ESL	3	Manual
G692_XV_F	G692-XV Limit Switch Fault	G692-ZSC AND G692-ZSO	3	Auto
G692_XV_ZAC	G692-XV Damper Failed to Close	G692-YS AND NOT 692-MN AND NOT G692-ZSC for 3 min	3	Auto
G692_XV_ZAO	G692-XV Damper Failed to Open	G692-YS AND G692-MN AND (G692-ZSC for 15 sec OR NOT G692-ZSO for 120 sec)	3	Auto

 SNC-LAVALIN	FUNCTIONAL REQUIREMENTS SPECIFICATION - PLC		Document Code: 112577-0116-48ER-0001
			Revision: 00
Client: City of Winnipeg	Project: SEWPCC Ventilation Upgrades	Package / Area: Wet Well and Grit Electrical & Blower Room Ventilation	

5.11.5 Interlocks

Initiating Event	Action	Control Mode		Display Interlock	Description
		Auto	Manual		
G552_ESL	Stop	Y	Y	Y	Stop G692-EF on MCC-2G Power Fail
NOT G692-UL OR NOT G692-YS	Stop	Y	Y	N	Turn off the Run Cmd output if the starter is not ready or not in Auto
G692_RunFault	Stop	Y	Y	N	Stop G692-EF if there is a Run Fault
G692-MM AND NOT G692-ZSO	Stop	Y	Y	N	Stop if damper not open (Duplicated in hardware)

5.11.6 Control Narrative

Turn on G692-EF when the room temperature (G692-TT) equals or exceeds G692_StartSP for 60 sec. Turn off G692-EF when the room temperature (G692-TT) is 3°C below the setpoint for 5 minutes.

Create a *Damper Opening* text animation on the equipment faceplate, that is active when G692-MN and NOT G692-ZSO.

 SNC-LAVALIN	FUNCTIONAL REQUIREMENTS SPECIFICATION - PLC		Document Code: 112577-0116-48ER-0001
			Revision: 00
Client: City of Winnipeg	Project: SEWPCC Ventilation Upgrades	Package / Area: Wet Well and Grit Electrical & Blower Room Ventilation	

5.12 LCP-G2 Monitoring

PLC: PLC-G11

5.12.1 PLC-I/O

Discrete:

Tag	Type	Description	0 State	1 State	Display
G902-EL-1	DI	LCP-G2 PS01 Power OK	Fail	OK	GD4-T
G902-EL-2	DI	LCP-G2 PS02 Power OK	Fail	OK	GD4-T

5.12.2 HMI - PLC Interface

Analog Values:

Tagname	Description	Range	Type	Display
G902_Heartbeat	PLC-G11 Heartbeat	0 - 32767	R	System Health

5.12.3 Alarms

Tagname	Description	Logic	Pri	Reset
G902_EA_1	LCP-G2 PS01 Power Supply Fail	NOT G902-EL-1 for 0.5 sec	3	Auto
G902_EA_2	LCP-G2 PS02 Power Supply Fail	NOT G902-EL-2 for 0.5 sec	3	Auto

5.12.4 Control Narrative

A heartbeat signal is to be implemented in the PLC so that remote devices can determine if the PLC is in Run mode (i.e. the RTU has not faulted).

Create a one second timer that increments a register, named "G902_Heartbeat", every one second. Increment the register to a set value (preferable 32767), reset to 0, and continue incrementing. This register will be monitored by the DCS.

 SNC-LAVALIN	FUNCTIONAL REQUIREMENTS SPECIFICATION - PLC		Document Code: 112577-0116-48ER-0001
			Revision: 00
Client: City of Winnipeg	Project: SEWPCC Ventilation Upgrades	Package / Area: Wet Well and Grit Electrical & Blower Room Ventilation	

5.13 Power Monitoring

PLC: PLC-G11

5.13.1 HMI - PLC Interface

Analog Values:

Read the following from the MCC-2G Power Meter via Modbus TCP at 10 second intervals:

IP Address: XXX.XXX.XXX.XXX Slave Node: X

Register	Tagname	Description	Range	Type	Display
4629	G552_ET	MCC-2G Voltage Average L-L	0 – 1,000 V	R	GD4-T

5.13.2 Alarms

Tagname	Description	Logic	Pri	Reset
G552_EAL	MCC-2G Power Failure	G552_ET < 540 V and NOT CommFail	3	Auto
MCC_2G_PM_CommFail	MCC-2G.PM Communication Failure	No communication for 30 seconds	3	Auto