

Eastbound Ness, F/S Opp Braintree  
Stop 20179 Braintree

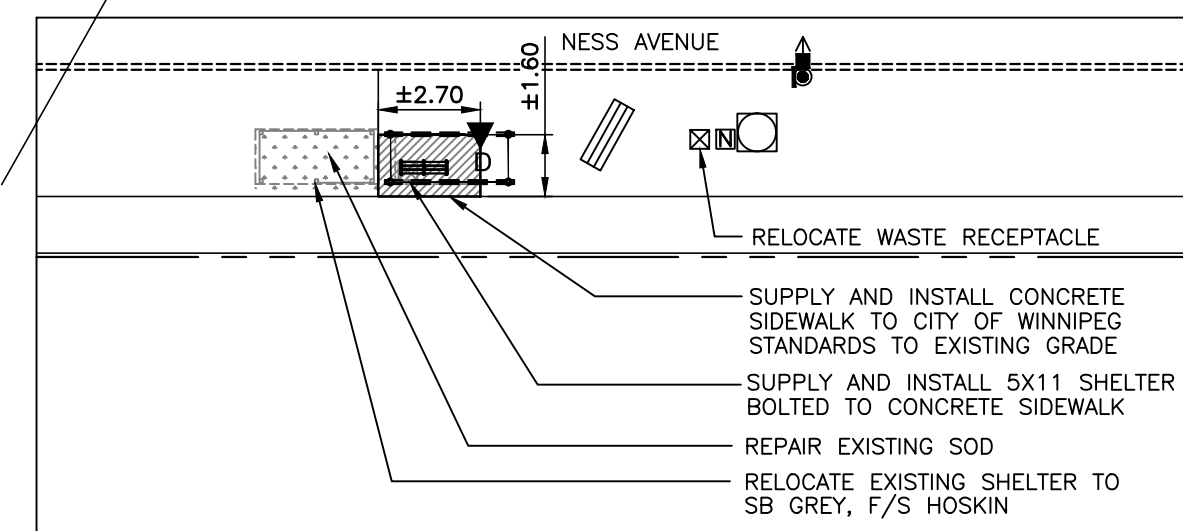

Eastbound Ness, N/S Whytewold  
Stop 20181 Whytewold

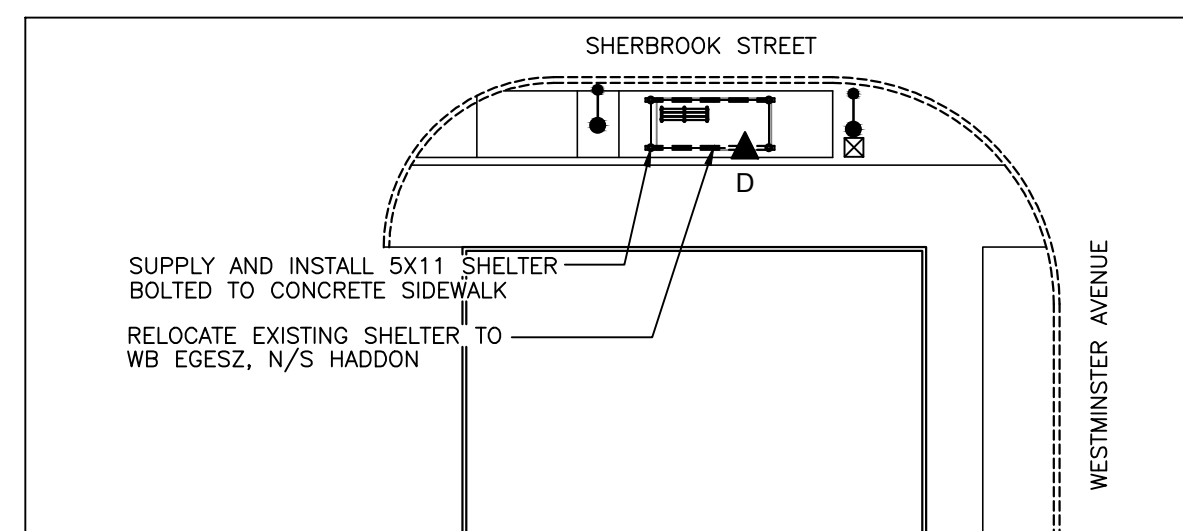

Northbound Sherbrook, N/S Westminister  
Stop 10205 Westminister

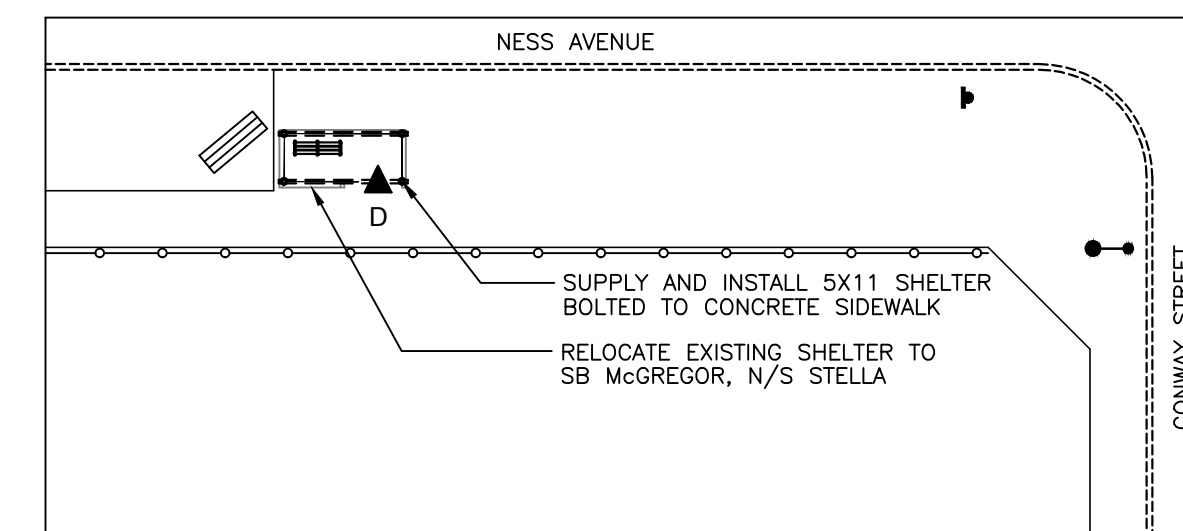

Eastbound Ness, N/S Conway  
Stop 20184 Conway

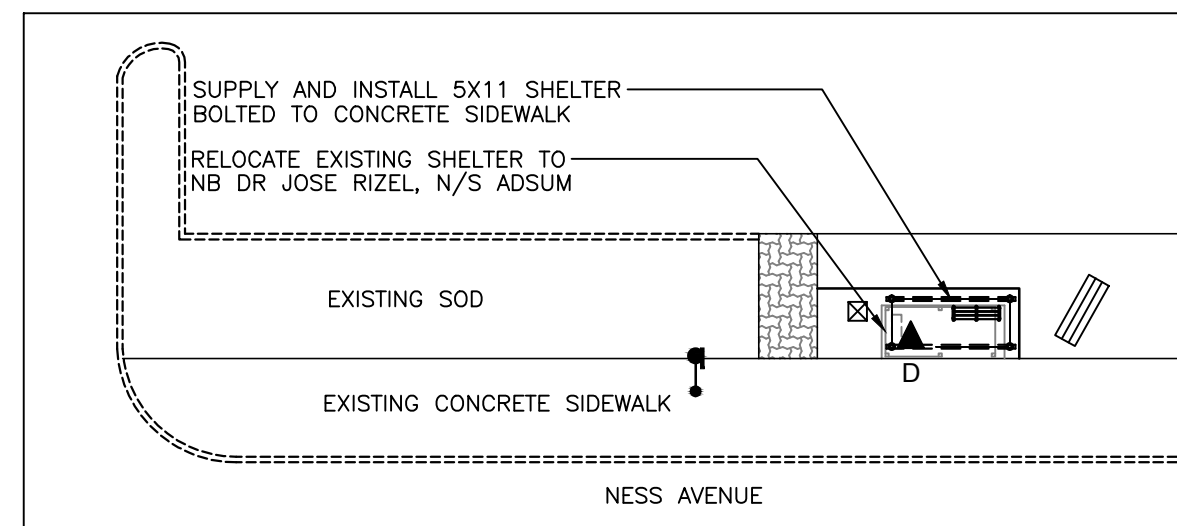

Westbound Ness, F/S Moray  
Stop 20156 Moray

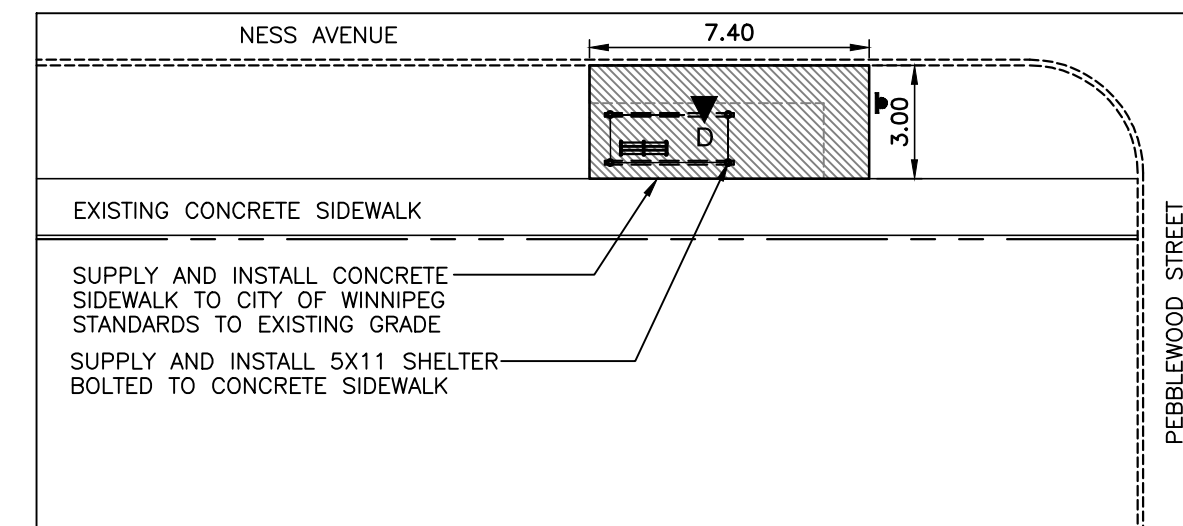

Eastbound Ness, N/S Pebblewood  
Stop 20173 Pebblewood

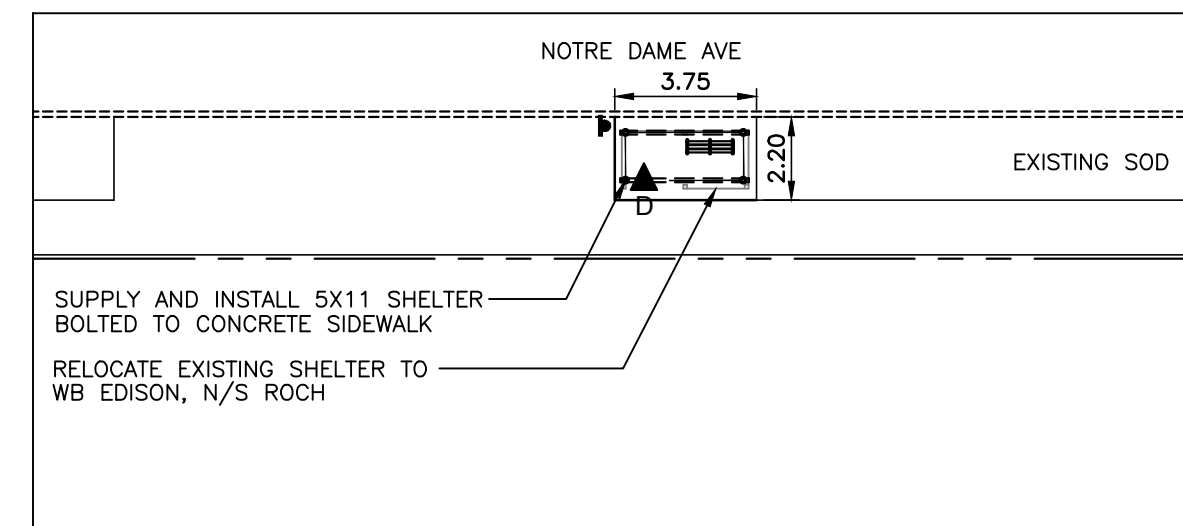

Eastbound Notre Dame, F/S Opp Tentler  
Stop 20032 Tentler

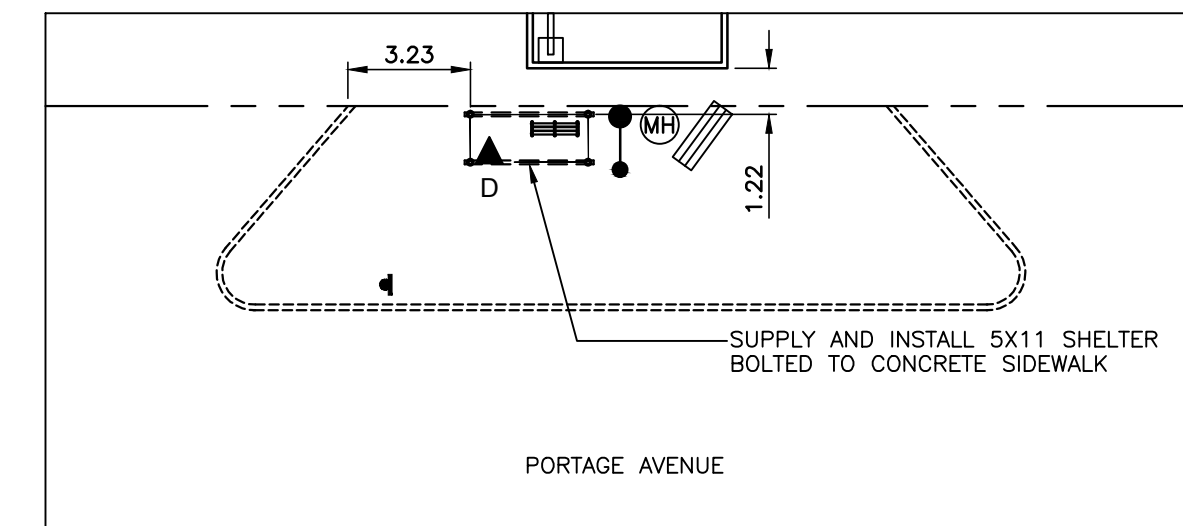

Westbound Portage, N/S Inglewood  
Stop 20208 Inglewood

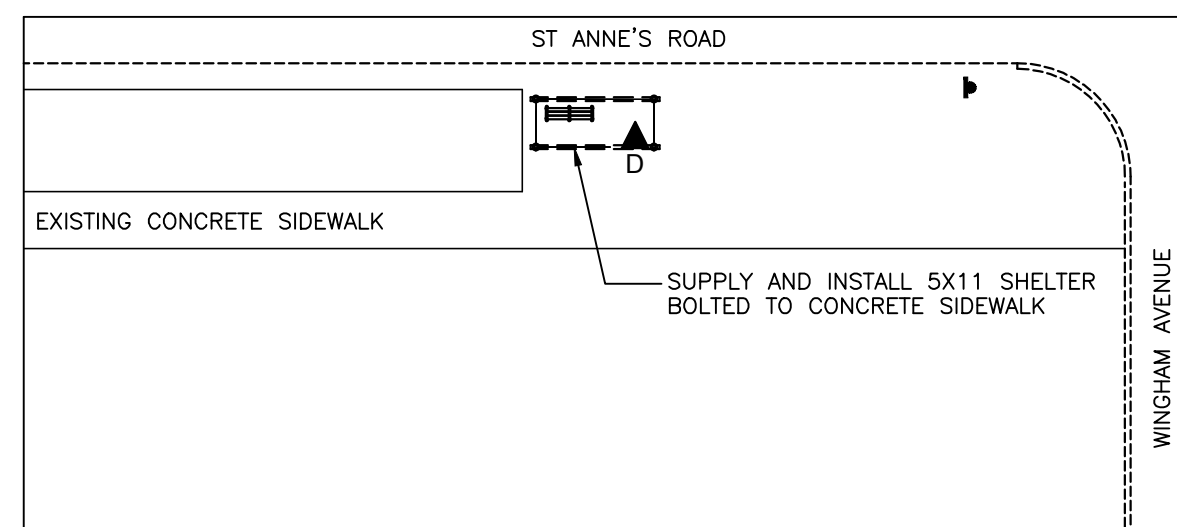

Northbound St Anne's, N/S Wingham  
Stop 50530 Wingham

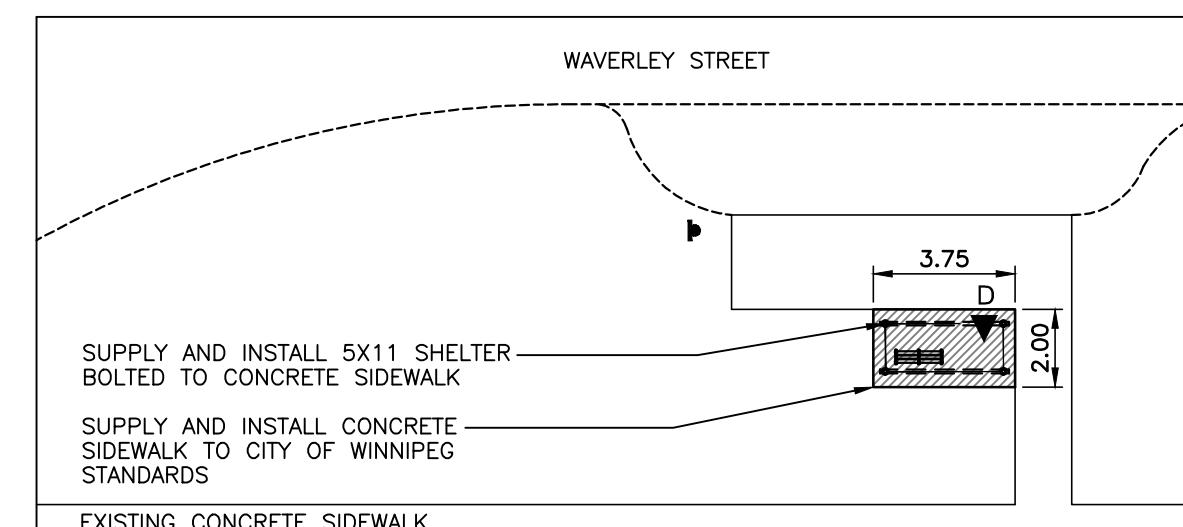

Northbound Waverley, F/S Wilkes  
Stop 60730 Wilkes North

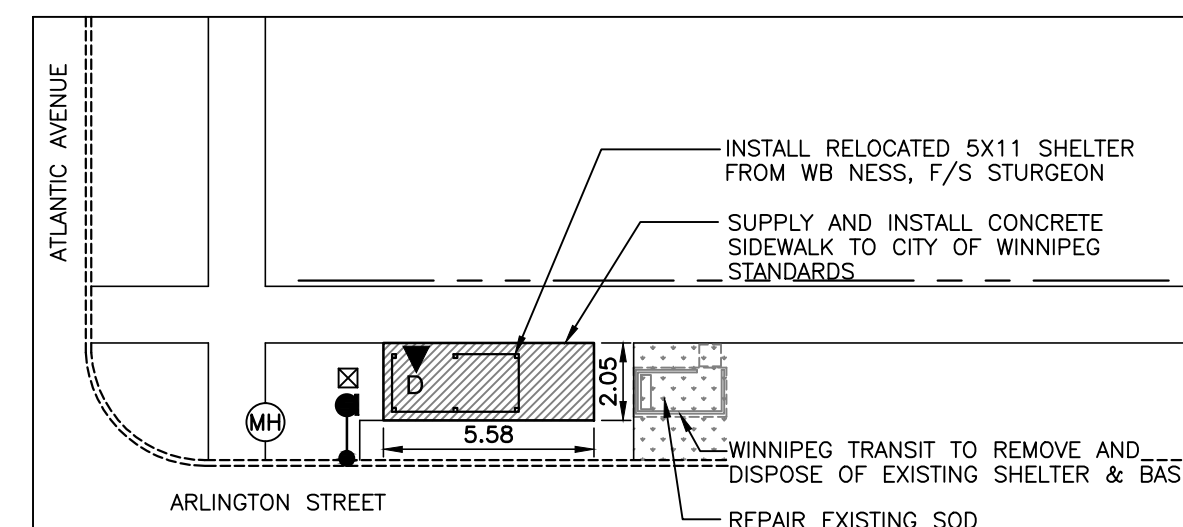

Southbound Arlington, N/S Atlantic  
Stop 30300 Atlantic

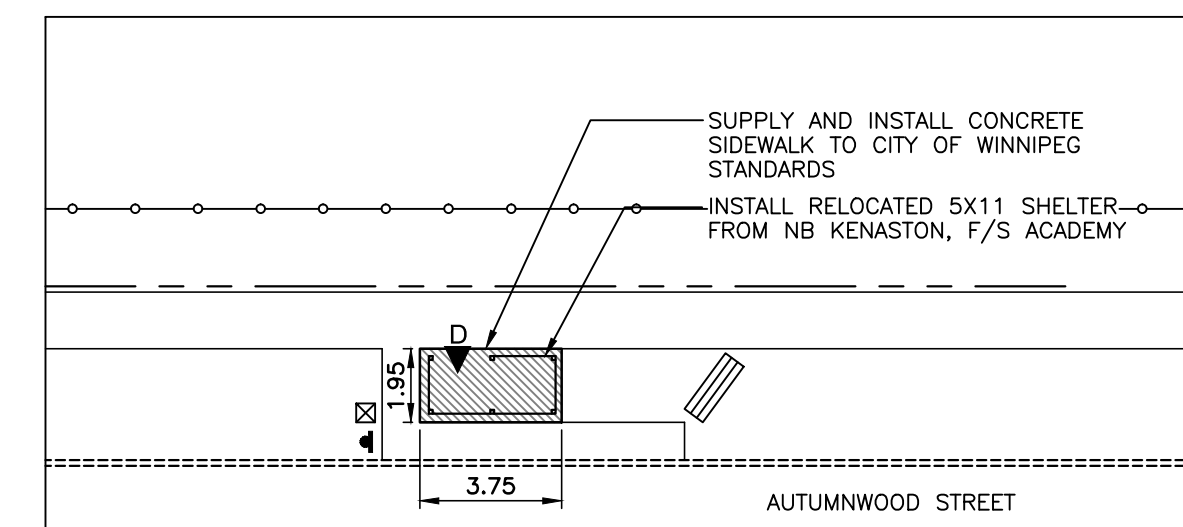

Southbound Autumnwood, N/S Opp Canberra  
Stop 50106 Canberra

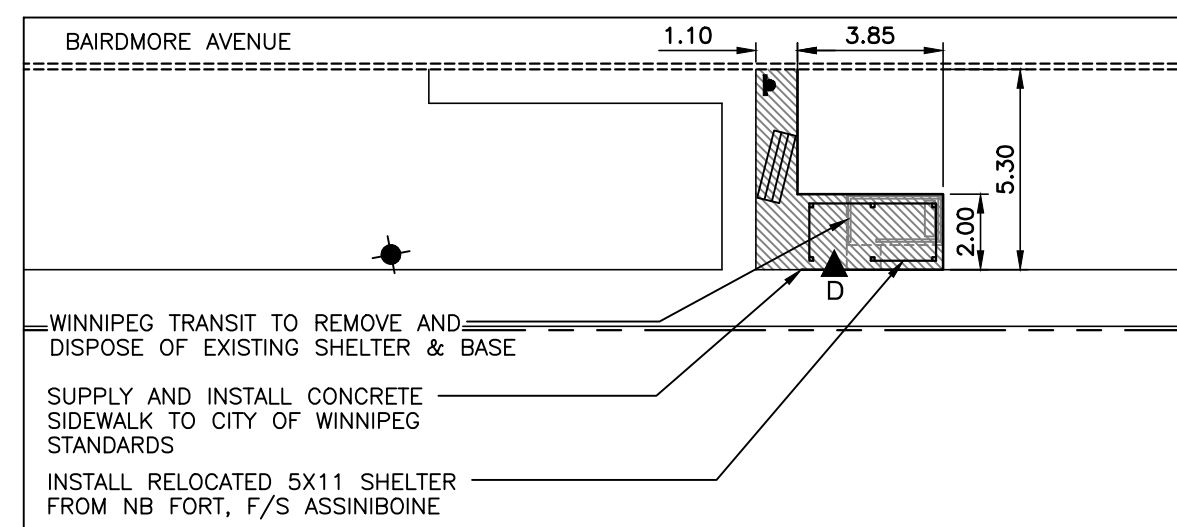

Northbound Bairdmore, N/S Kirkbridge  
Stop 61017 Kirkbridge

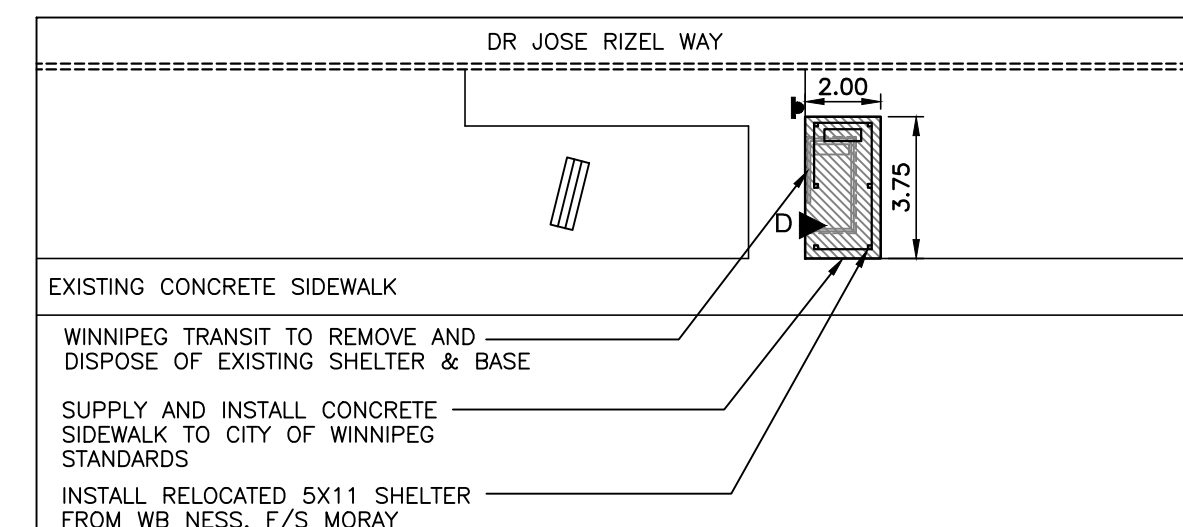

Northbound Dr Jose Rizel, N/S Adsum  
Stop 30772 Adsum

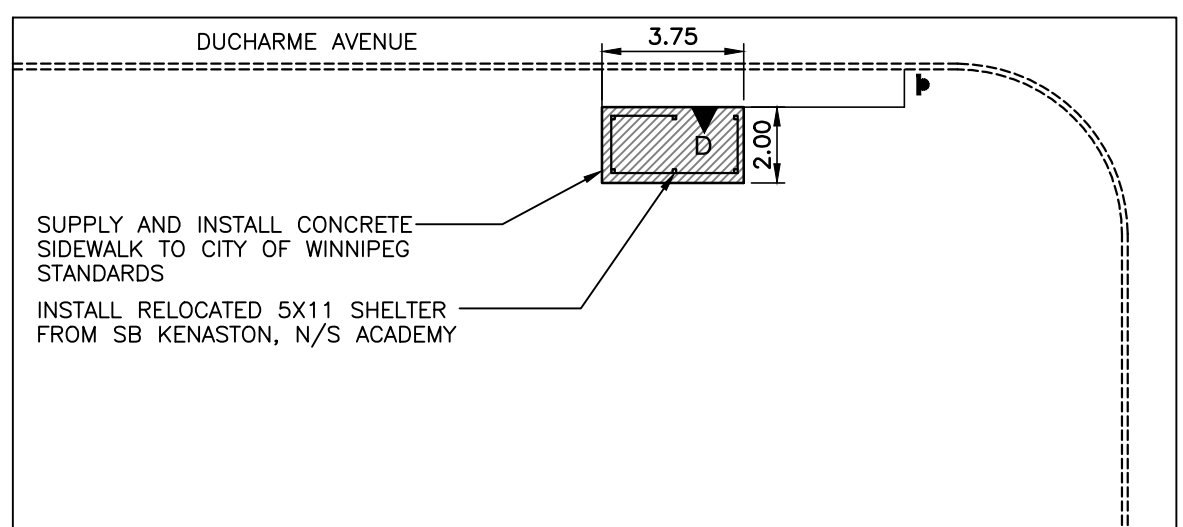

Eastbound Ducharme, F/S Le Maire  
Stop 60017 Le Maire

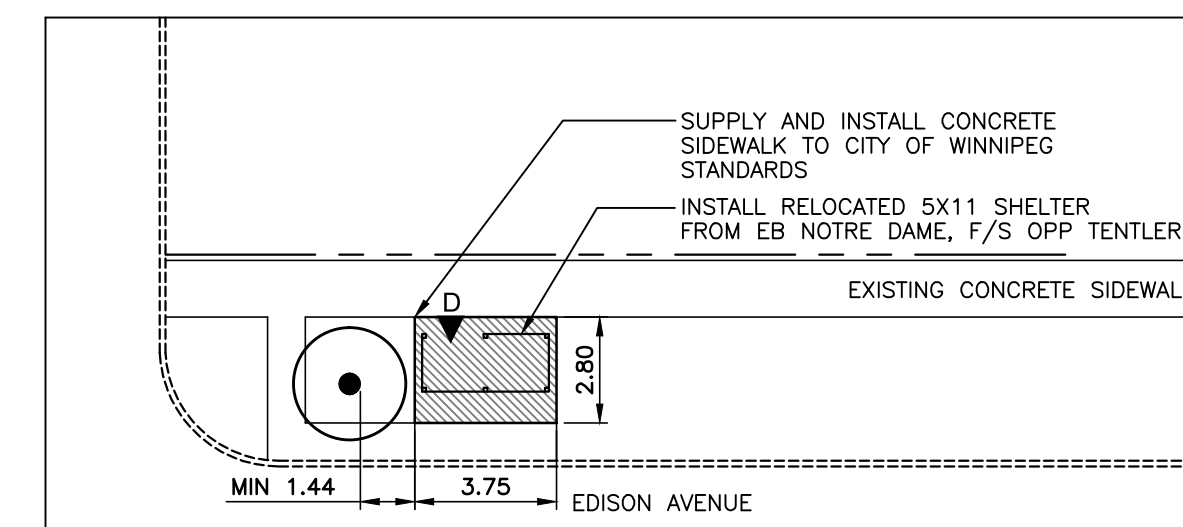

Westbound Edison, N/S Roch  
Stop 40555 Roch

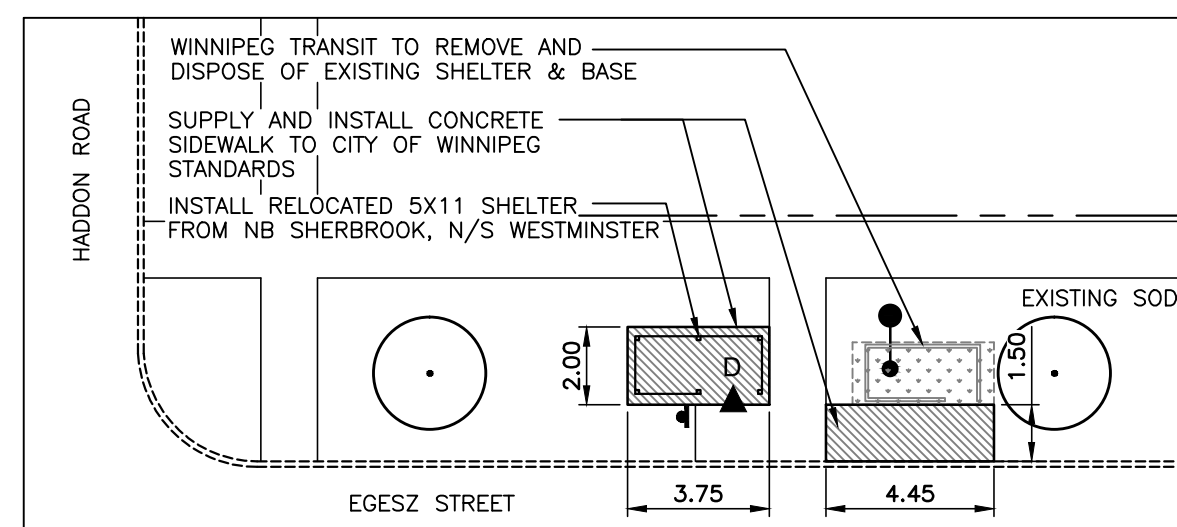

Westbound Egesz, N/S Haddon  
Stop 30708 Haddon

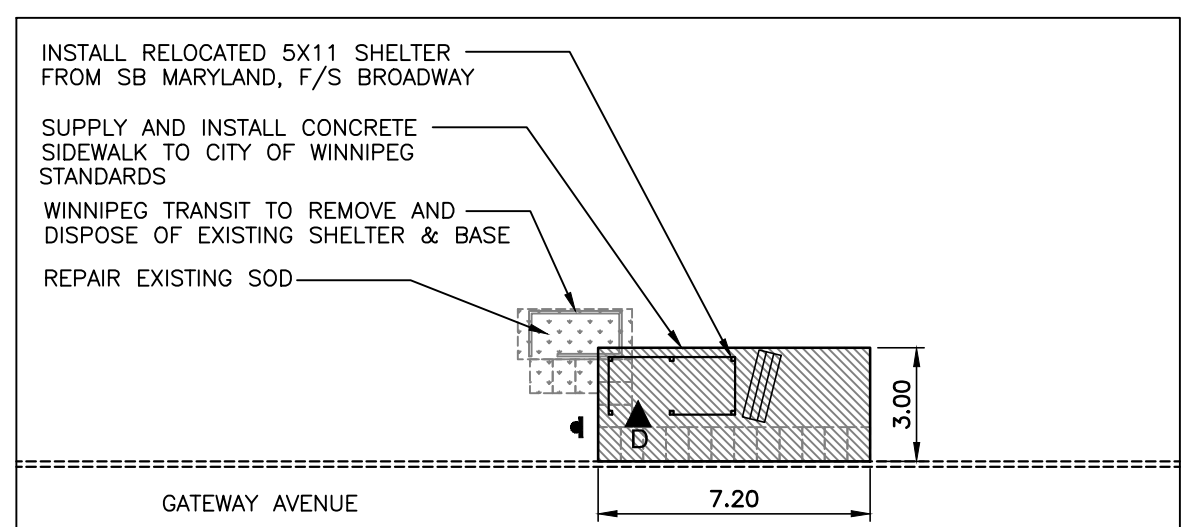

Southbound Gateway, F/S Opp Jim Smith  
Stop 40745 Jim Smith

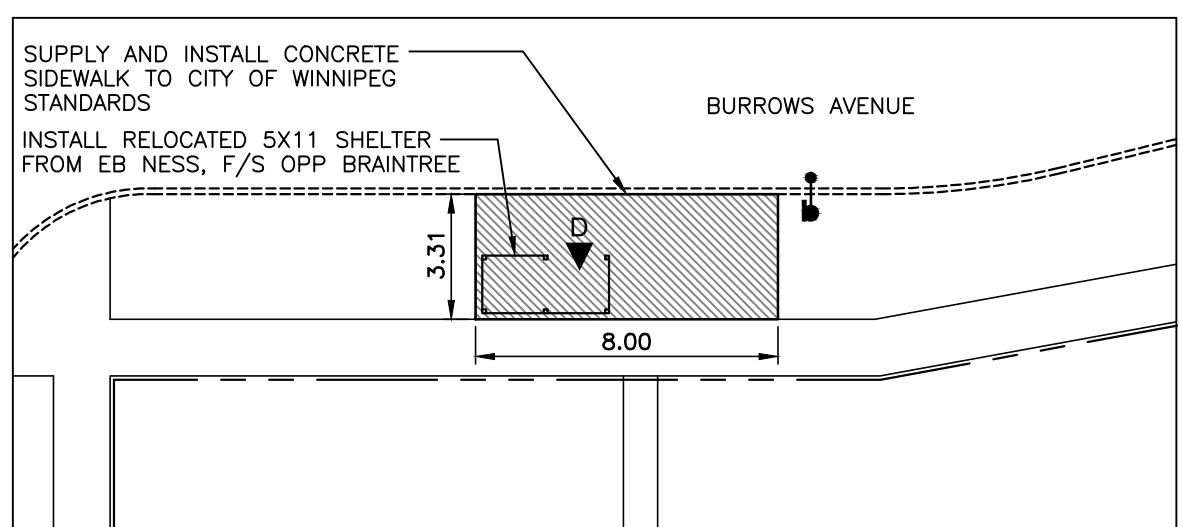

Eastbound Burrows, F/S Gilbert  
Stop 30667 Gilbert

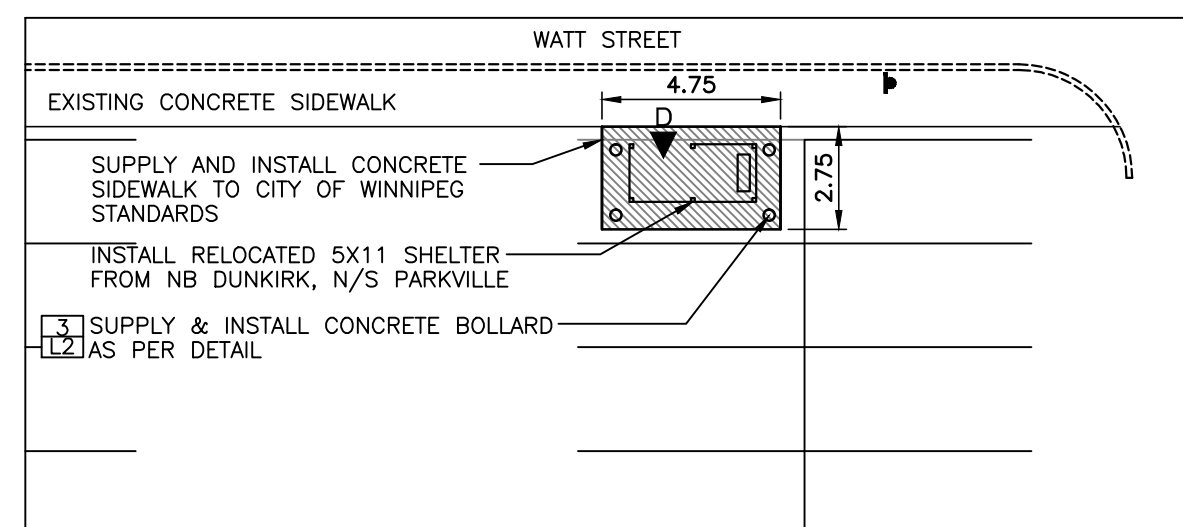

Northbound Watt, N/S Munroe  
Stop 40483 Munroe



**LEGEND**

**EXISTING**

- PROPERTY LINE
- - - - - EXISTING CURB
- EXISTING COBRA LIGHT POLE
- EXISTING HYDRANT
- BENCH TO BE REMOVED
- MTS PHONE BOOTH
- WASTE RECEPTACLE
- EXISTING TREE TO REMAIN
- - - - - EXISTING SIDEWALK TO BE REMOVED
- EXISTING SIGN TO BE REMOVED
- EXISTING TRAFFIC SIGNAL
- EXISTING MAN HOLE

**PROPOSED**

- HOLLAND PAVERS
- PINNED CONCRETE CURB / CURB RENEWAL
- ▨ PROPOSED CONCRETE SIDEWALK
- ▤ SOD
- RELOCATED 5X11 DAYTECH
- CBS 5X11 SHELTER
- 5X11 DAYTECH SHELTER TO BE RELOCATED
- ALUMINUM SHELTER TO BE REMOVED
- ▲ DOOR LOCATION

No.	Revisions	Date	By
12-20-11	Scale	1:200	
MD	MD	JW	

**McGOWAN RUSSELL**  
Client

**WINNIPEG TRANSIT**  
Project Title

**BUS STOP IMPROVEMENTS 2012**

Sheet Title

**SITWORKS LAYOUT PLANS**

Project No. 06-029 Drawing No. L1.2