

Westbound Concordia, F/S Molson
Stop 40235 Concordia Hospital

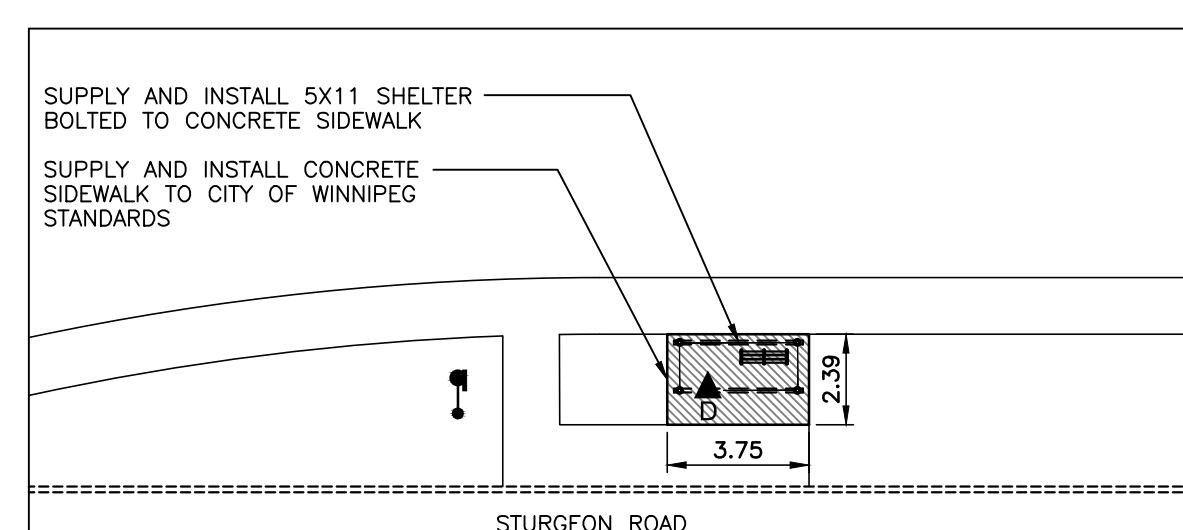

Southbound Sturgeon, N/S Portage
Stop 20296 Portage North

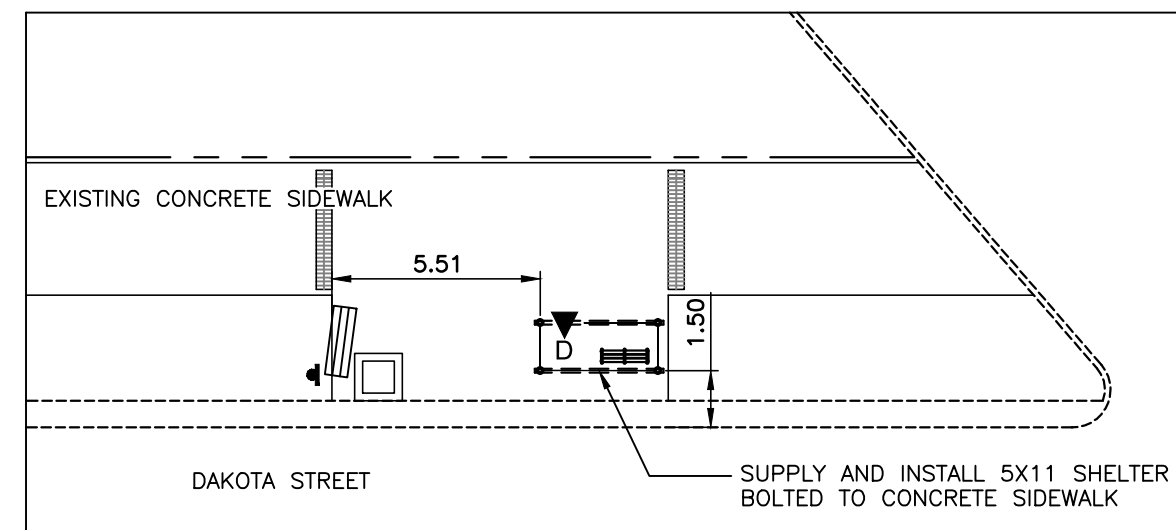

Southbound Dakota, F/S Leston
Stop 50504 Leston

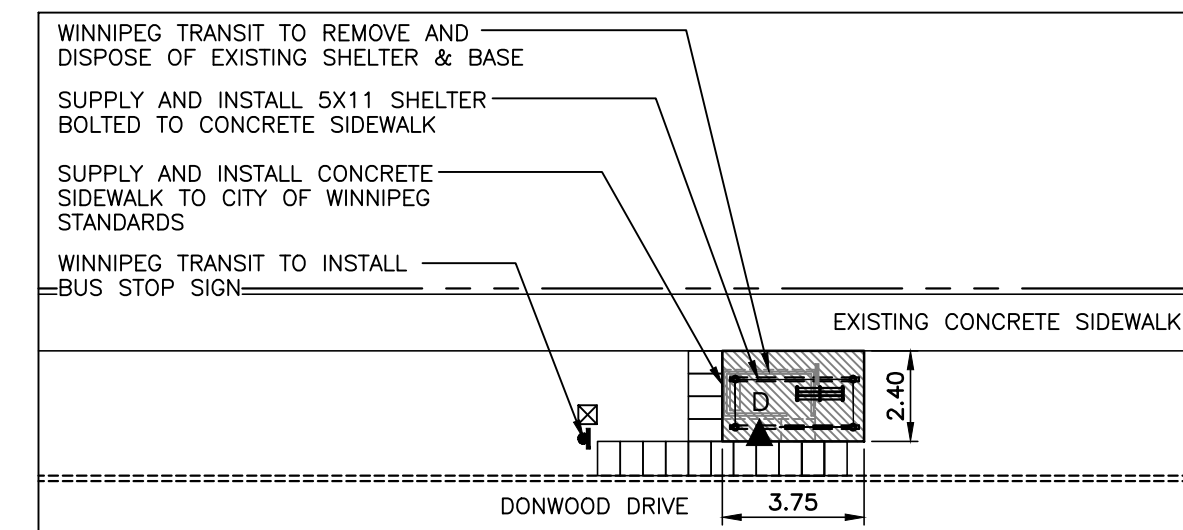

Westbound Donwood, F/S Pinecrest
Stop 40583 Pinecrest

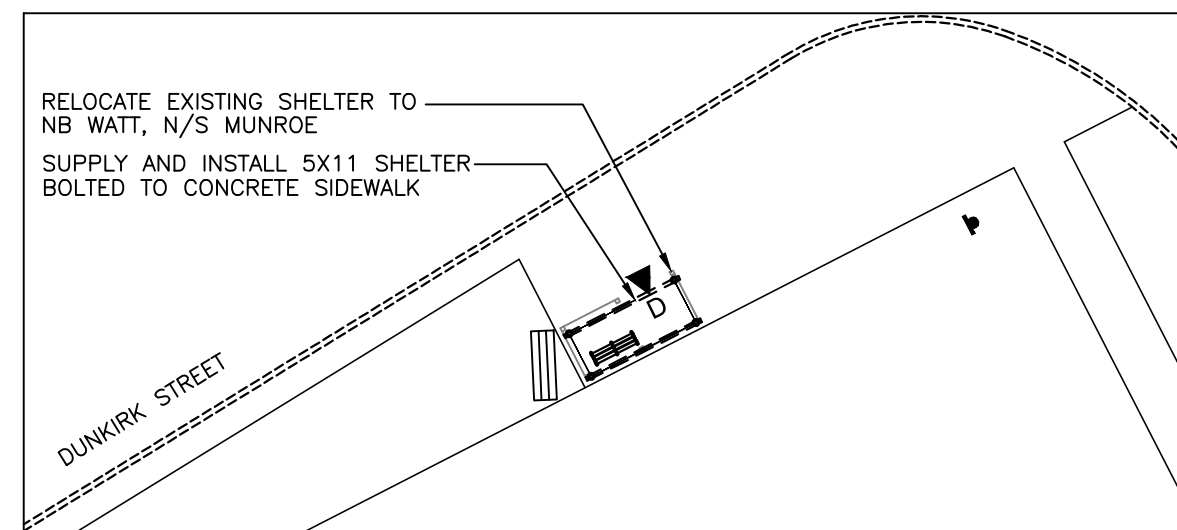

Northbound Dunkirk, N/S Parkville
Stop 50480 Parkville

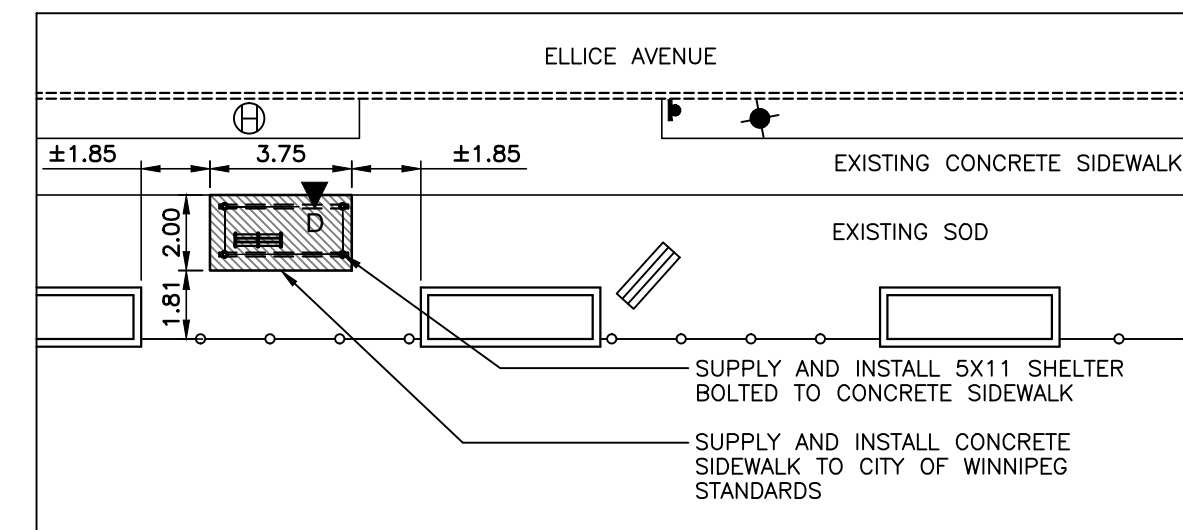

Eastbound Ellice, N/S Strathcona
Stop 10498 Strathcona West

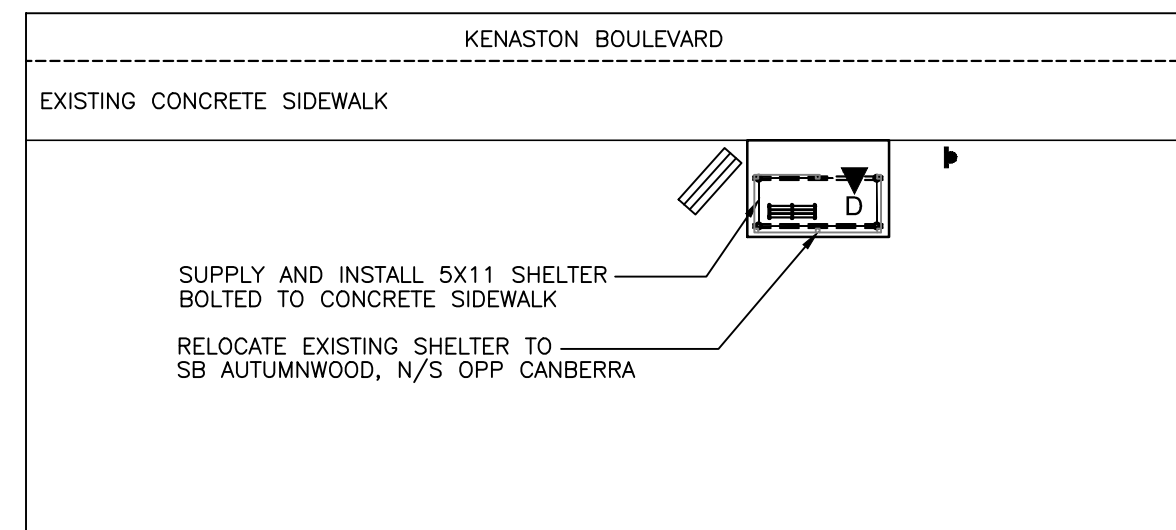

Northbound Kenaston, F/S Academy
Stop 60449 Academy

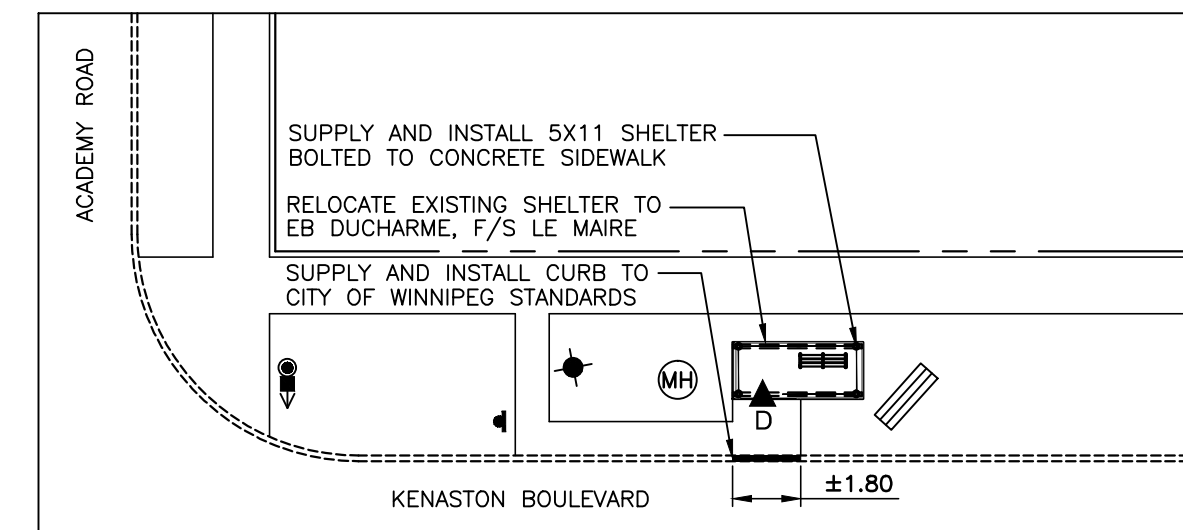

Southbound Kenaston, N/S Academy
Stop 60450 Academy

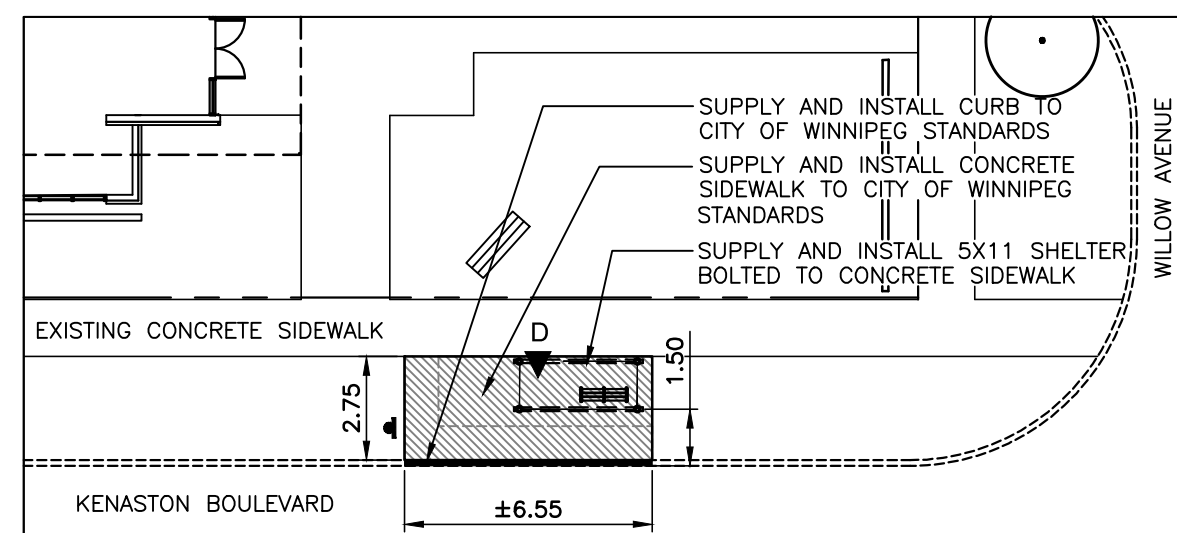

Southbound Kenaston, F/S Willow
Stop 60444 Willow

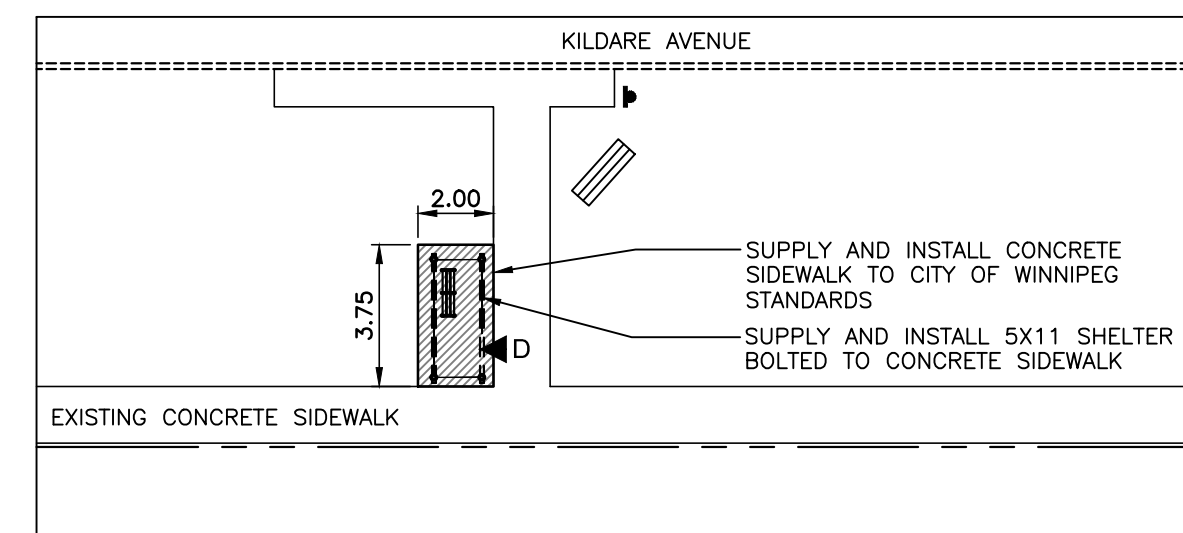

Eastbound Kildare, N/S Opp McMeans
Stop 40720 McMeans

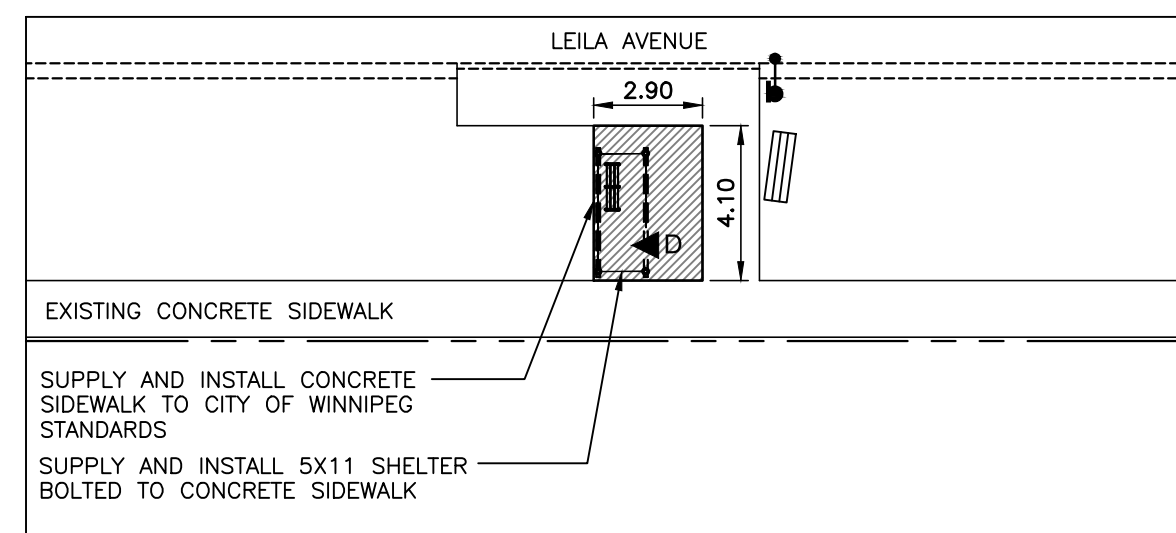

Eastbound Leila, N/S Diplomat
Stop 30384 Diplomat

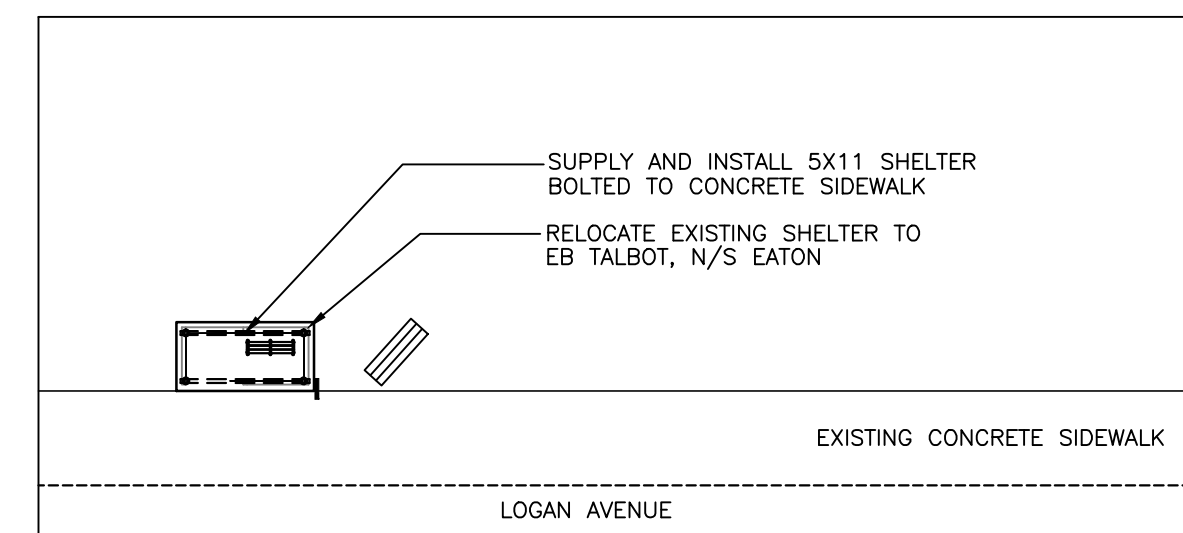

Westbound Logan, F/S Isabel
Stop 10342 Isabel

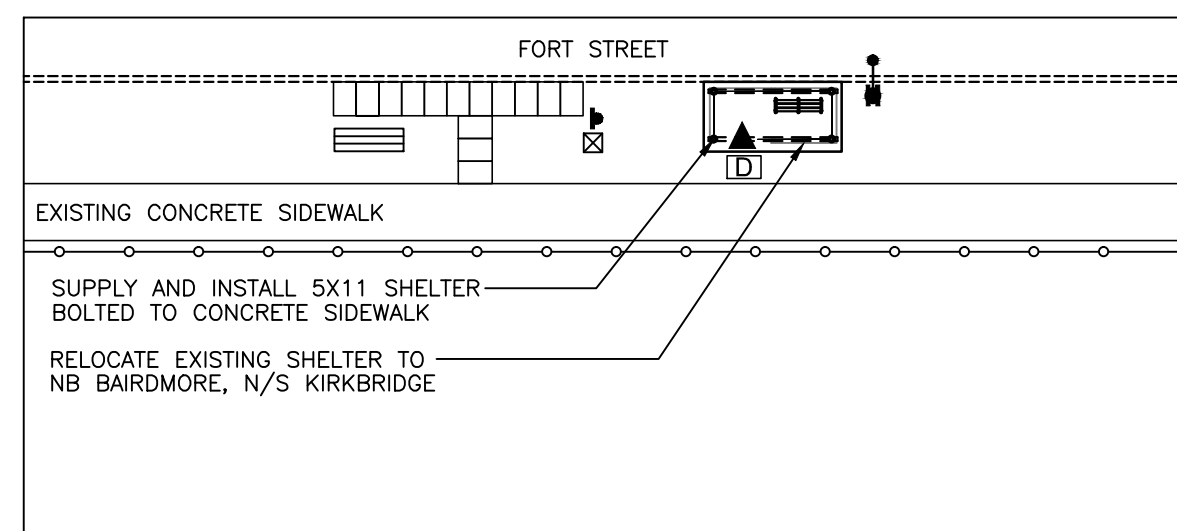

Northbound Fort, F/S Assiniboine
Stop 10830 Assiniboine

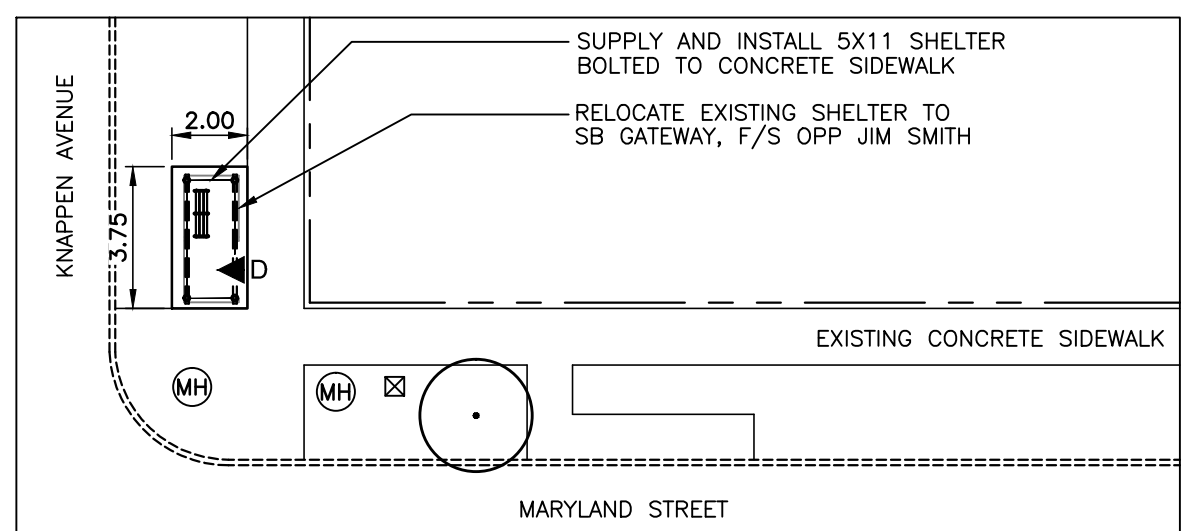

Southbound Maryland, F/S Broadway
Stop 10196 Broadway

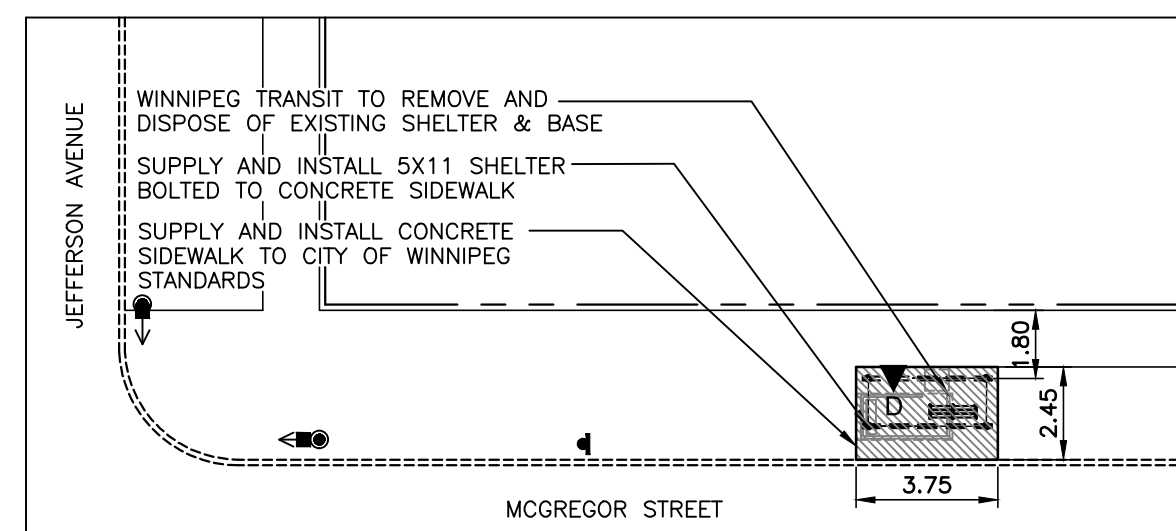

Southbound McGregor, N/S Jefferson
Stop 30220 Jefferson

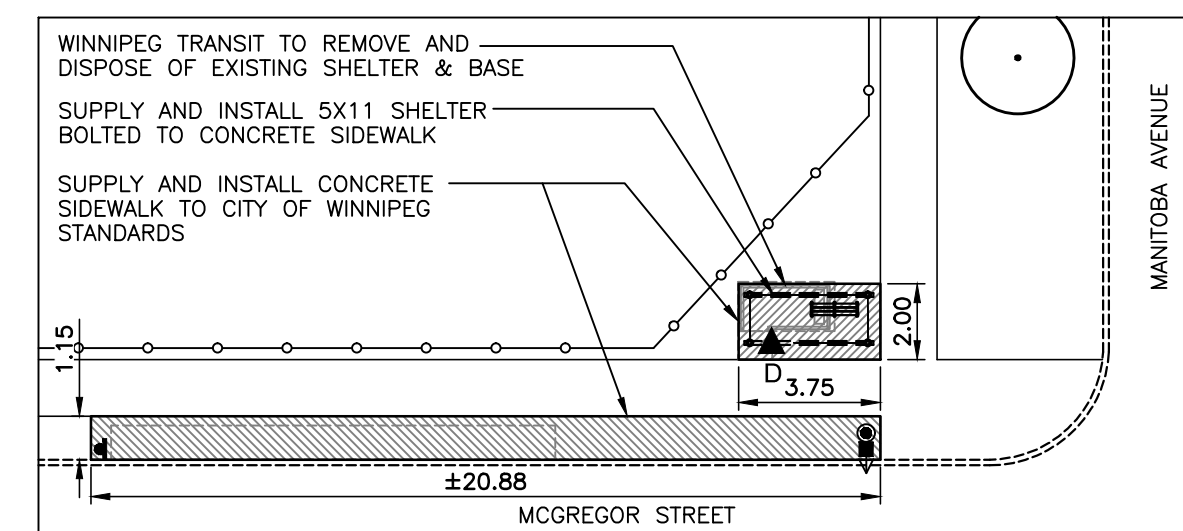

Southbound McGregor, F/S Manitoba
Stop 30257 Manitoba

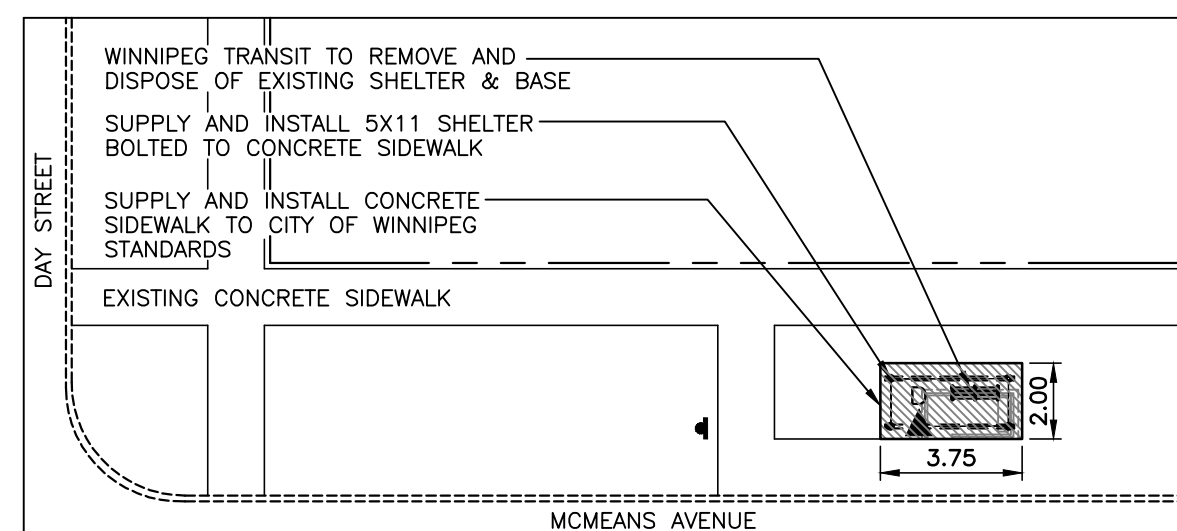

Westbound McMeans, N/S Day
Stop 40050 Day

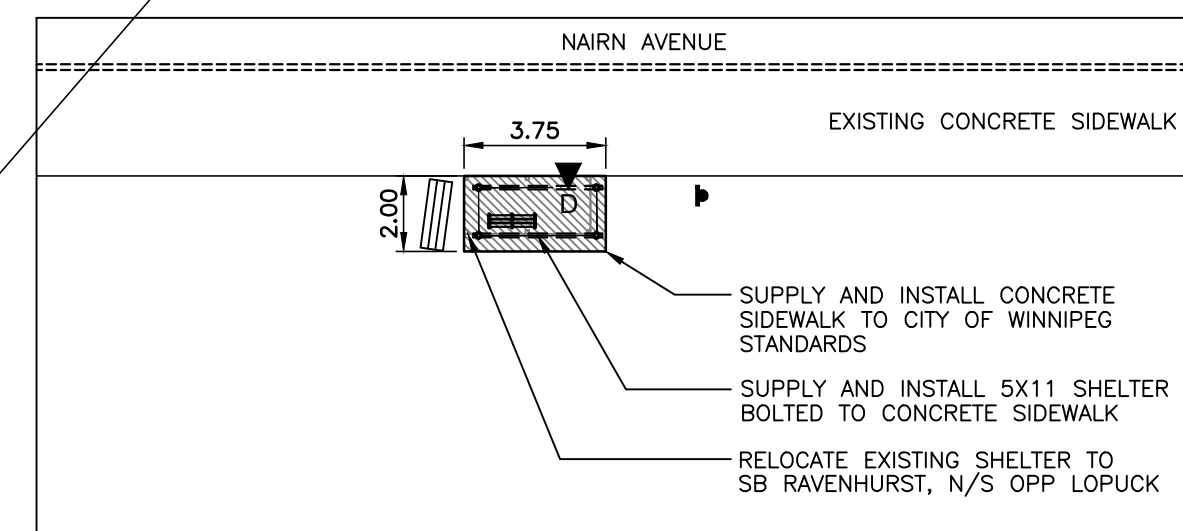

Eastbound Nairn, F/S Grey
Stop 40337 Grey

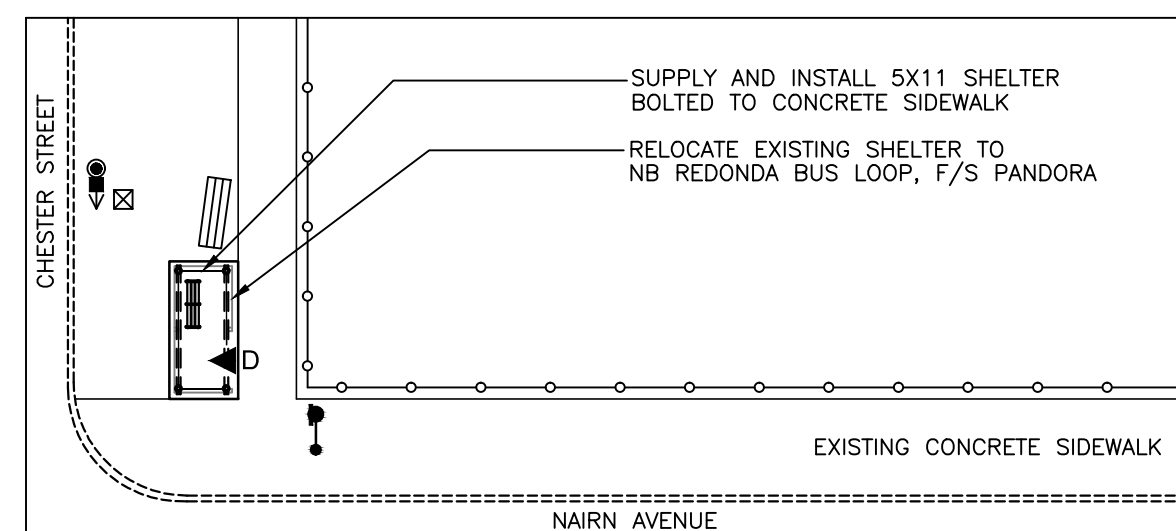

Westbound Nairn, N/S Chester
Stop 40314 Chester

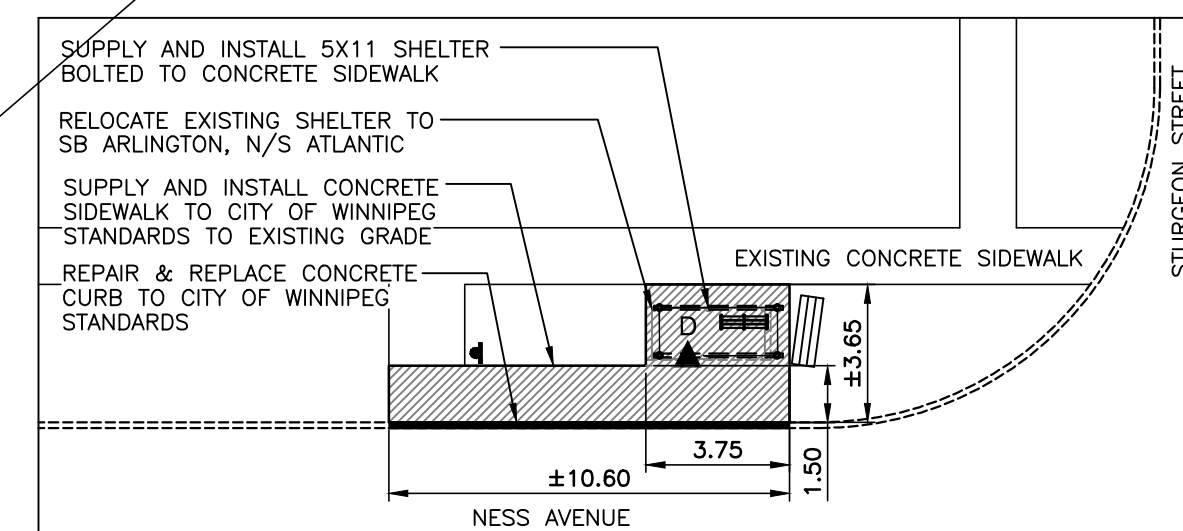

Westbound Ness, F/S Sturgeon
Stop 20160 Sturgeon



LEGEND

- EXISTING**
- PROPERTY LINE
 - EXISTING CURB
 - EXISTING COBRA LIGHT POLE
 - EXISTING HYDRANT
 - MTS PHONE BOOTH
 - WASTE RECEPTACLE
 - EXISTING TREE TO REMAIN
 - EXISTING SIDEWALK TO BE REMOVED
 - EXISTING SIGN TO BE REMOVED
 - EXISTING TRAFFIC SIGNAL
 - EXISTING MAN HOLE
- PROPOSED**
- HOLLAND PAVERS
 - ▬ PINNED CONCRETE CURB / CURB RENEWAL
 - ▨ PROPOSED CONCRETE SIDEWALK
 - ▤ SOD
 - RELOCATED 5X11 DAYTECH
 - CBS 5X11 SHELTER
 - 5X11 DAYTECH SHELTER TO BE RELOCATED
 - ALUMINUM SHELTER TO BE REMOVED
 - ▲ DOOR LOCATION

No.	Revisions	Date	By

Date: 12-20-11
Scale: 1:200

Designed By: MD
Drawn By: MD
Checked By: JW

Seals

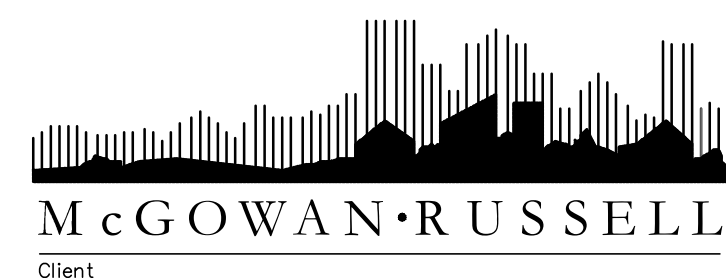

WINNIPEG TRANSIT
Project Title

BUS STOP IMPROVEMENTS 2012

Sheet Title

SITE WORKS LAYOUT PLANS

Project No. 06-029
Drawing No. L1.1