

15 PLAN AT EL. 244.400  
WP-M9101 1:150

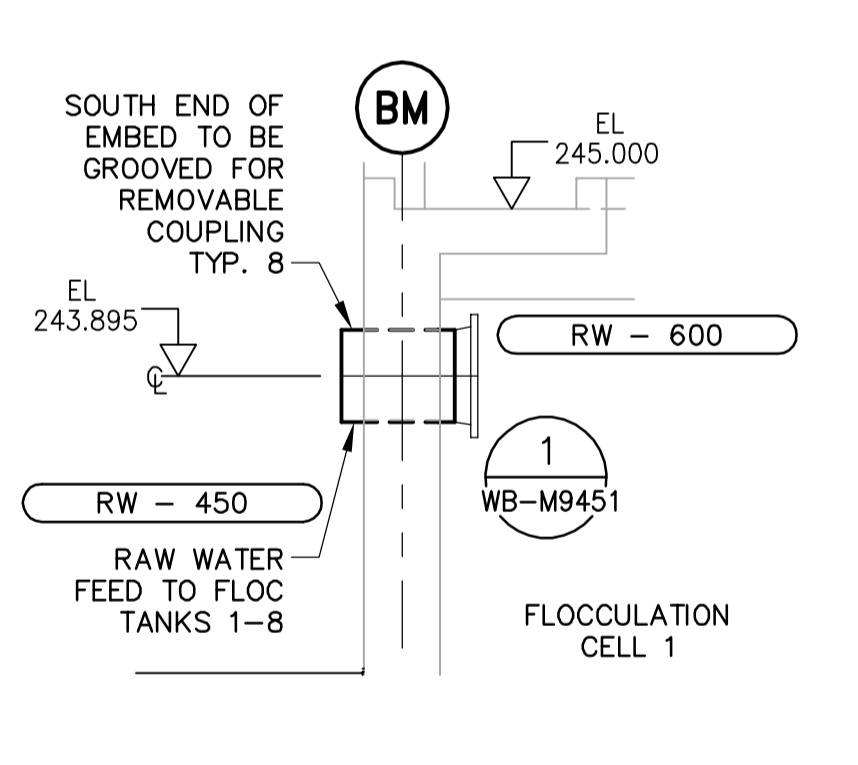

A SECTION - RAW WATER FEEDS TO FLOC TANKS - TYP. 8  
WP-M9101 1:50

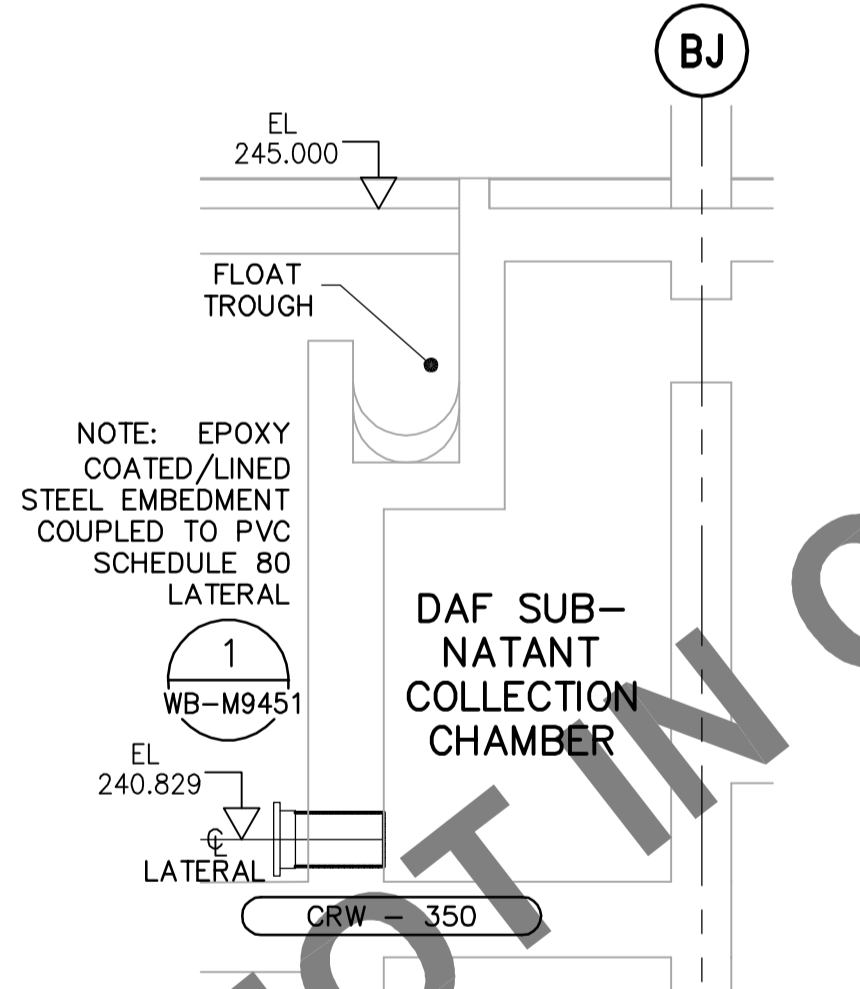

B SECTION - DAF LATERALS - TYP. 64  
WP-M9101 1:50

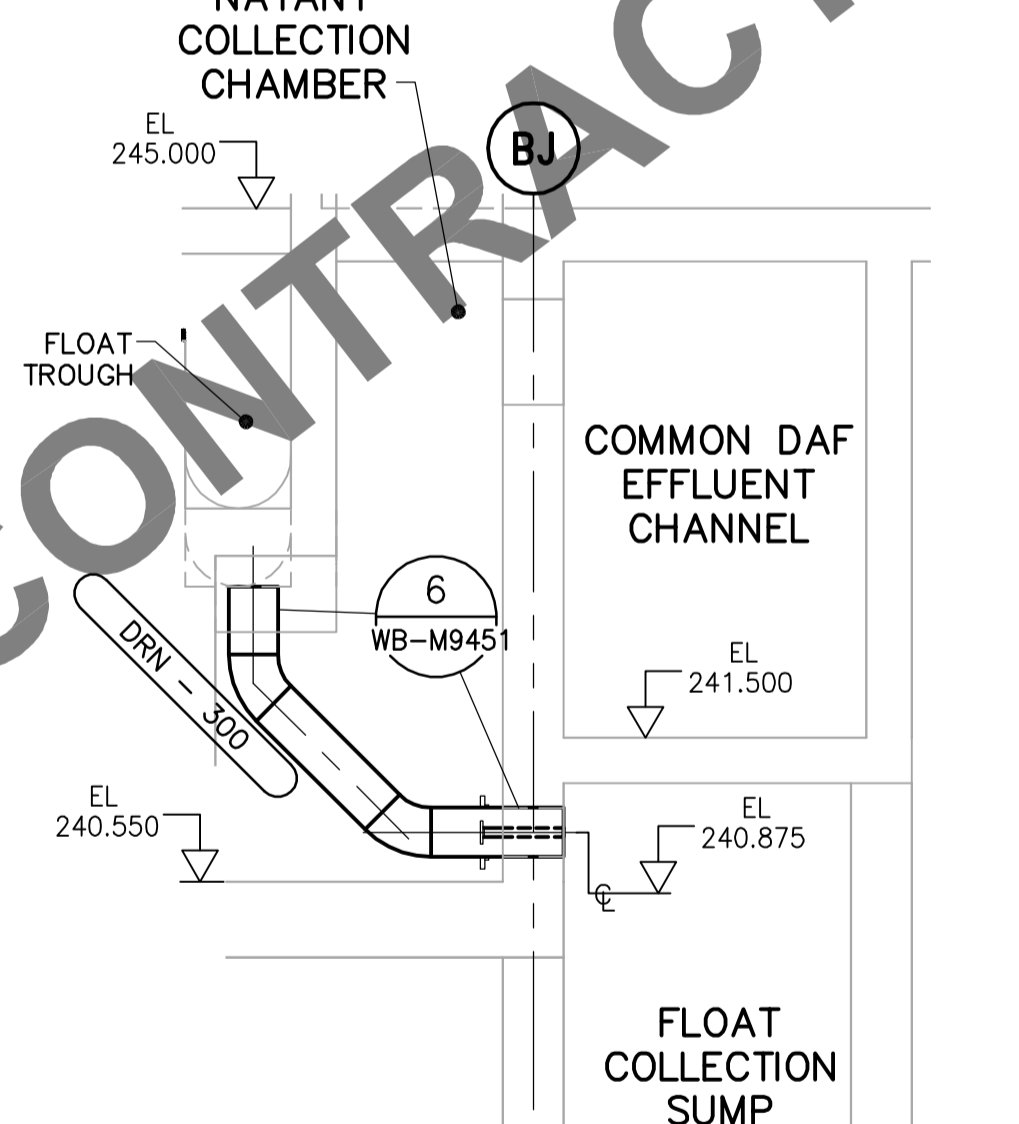

C SECTION - FLOAT TROUGH DRAINS TO FLOAT SUMPS TYP. 8  
WP-M9101 1:50

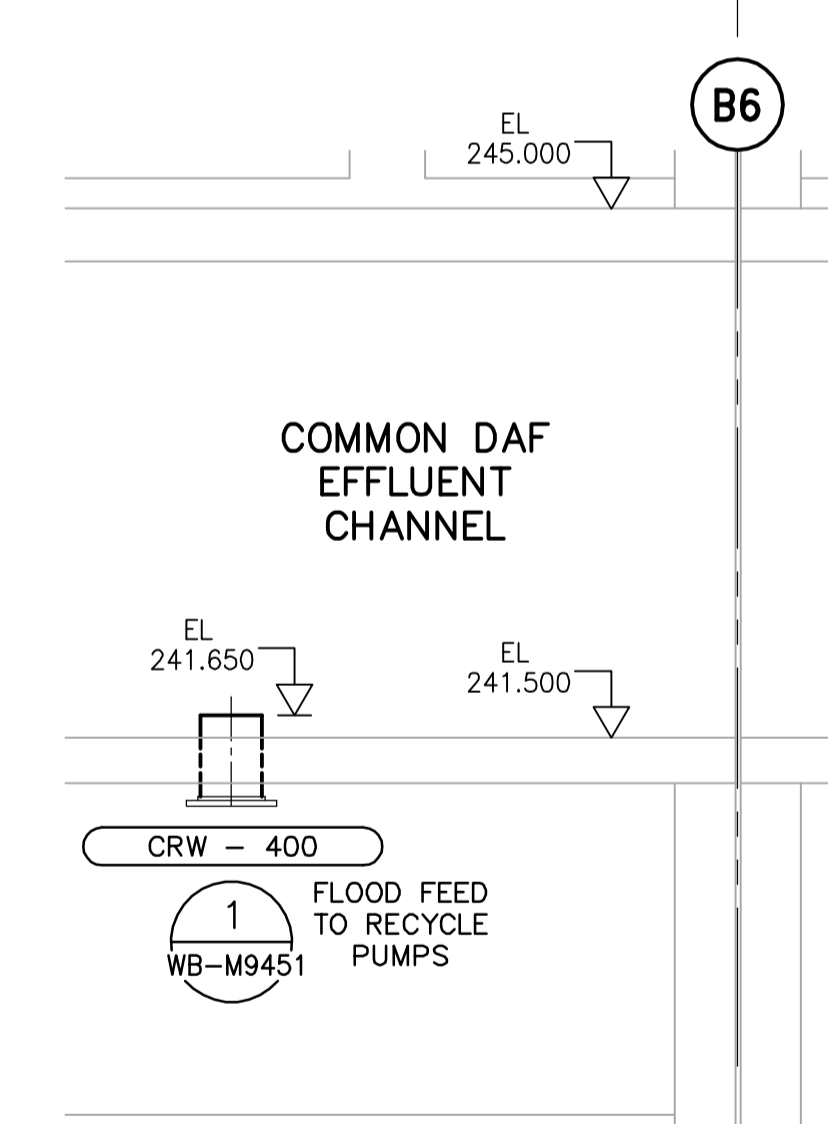

D SECTION - FEEDS TO RECYCLE PUMPS - TYP. 2  
WP-M9101 1:50

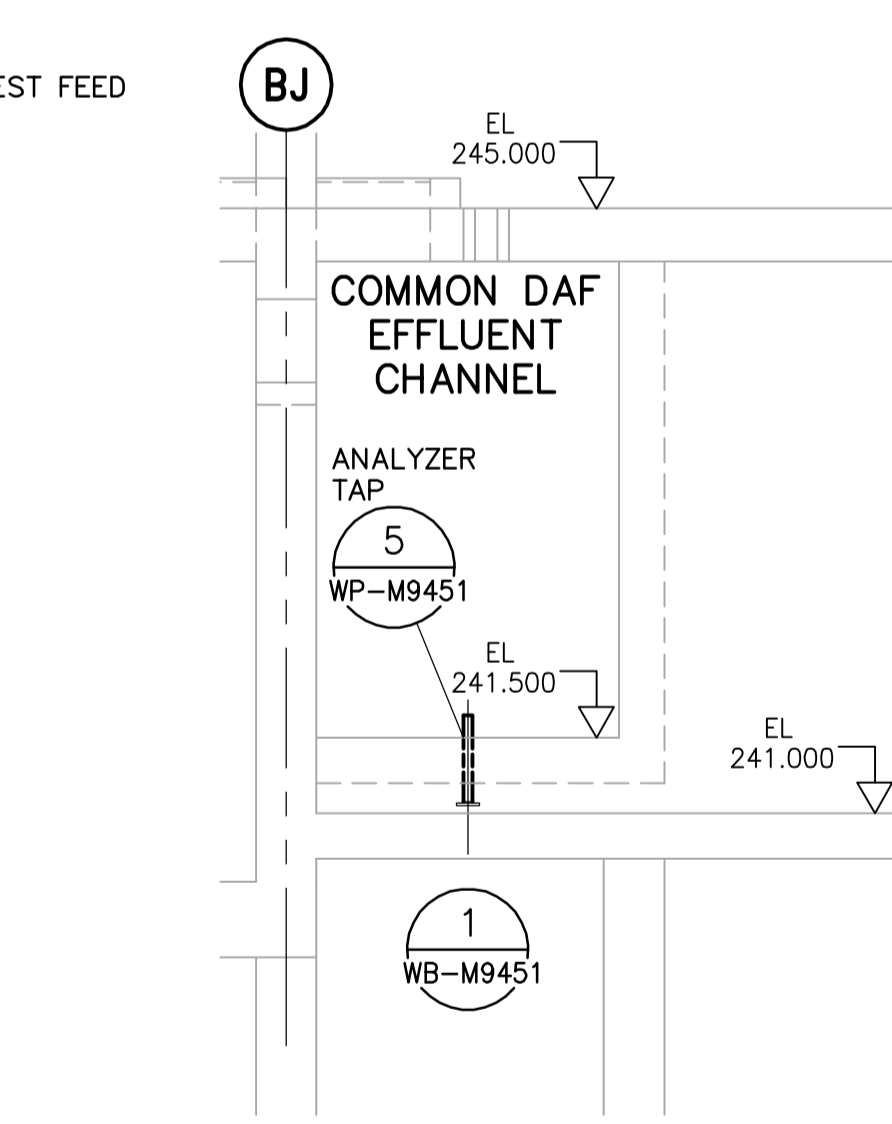

Q SECTION - EMBEDDED ANALYSER TAP TYP. 2  
WP-M9101 1:50

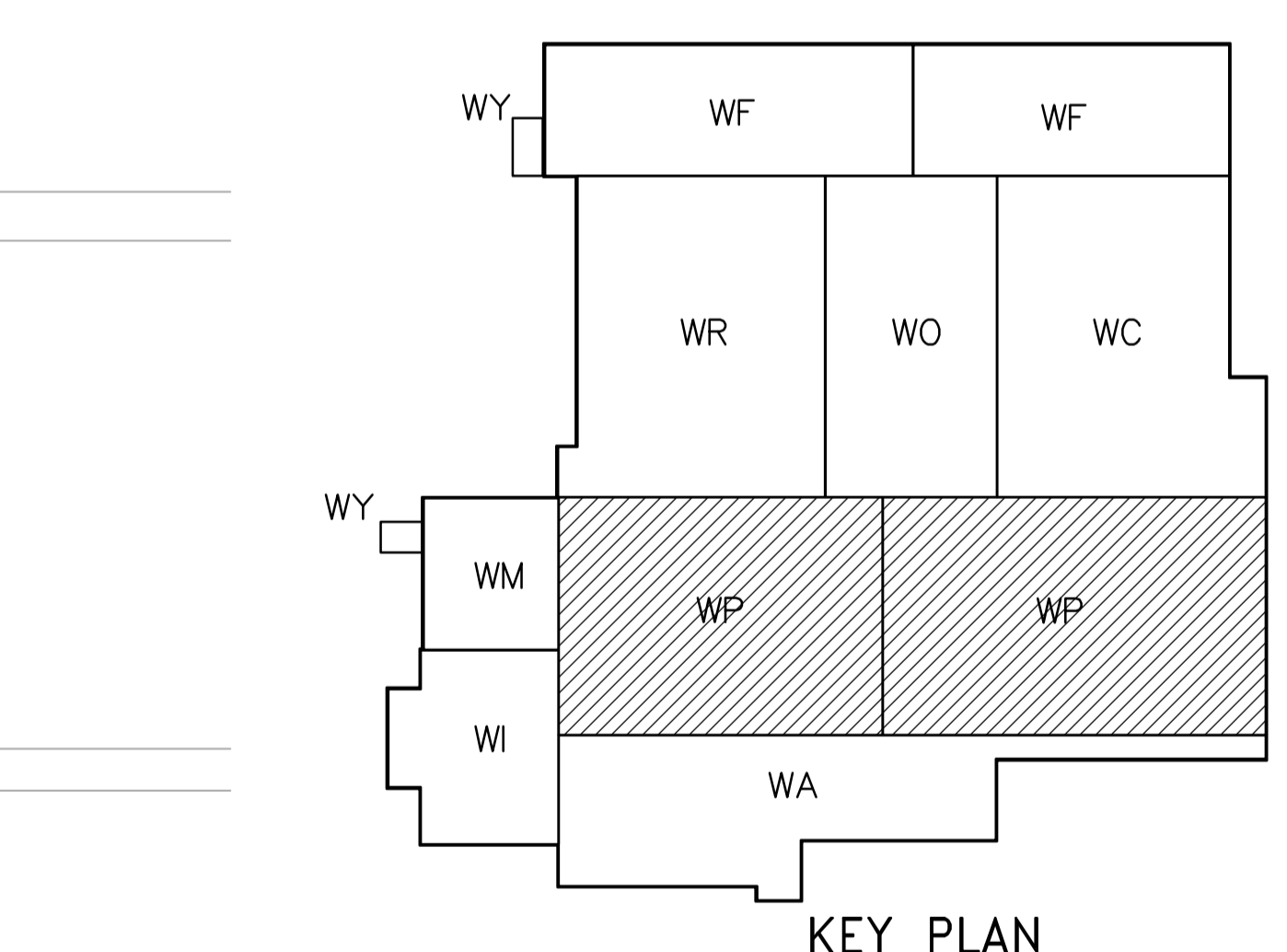

KEY PLAN

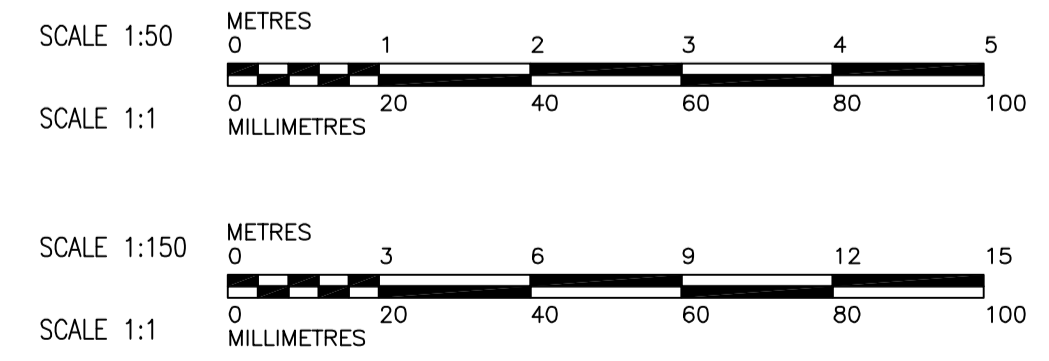

<p>Certificate of Authorization Earth Tech Canada Inc. No. 730 Expiry: April 30, 2006</p>		<p>Frederickson Cooper ARCHITECTS</p>		<p>A Tech International Ltd. Company</p>		<p>ENGINEER'S SEAL</p> <p>ORIGINAL SIGNED BY S.R. BILEVICIUS 2006/02/07</p> <p>CONSULTANT DRAWING NO. WP-M9101</p>	
<p>DESIGNED BY KAS</p> <p>DRAWN BY PL</p> <p>SCALE: AS SHOWN</p>		<p>CHECKED BY SRB</p> <p>APPROVED BY DJT</p> <p>RELEASED FOR CONSTRUCTION BY: R. SOROKOWSKI</p>		<p>DATE 2005/10/21</p> <p>DATE 2006/02/07</p>		<p>WATER TREATMENT PLANT FLOCCULATION AND DAF FOUNDATIONS AND CONCRETE STRUCTURES</p> <p>PIPE EMBEDS PLAN @ EL. 244.400 AND SECTIONS FLOCCULATION AND DAF TANKS</p>	
<p>00 ISSUED FOR TENDER 06/02/03 PL</p>		<p>NO. REVISIONS DATE BY</p>		<p>CITY FILE NUMBER</p>		<p>SHEET OF</p>	
<p>NO. REVISIONS DATE BY</p>		<p>DATE 2005/10/21 DATE 2006/02/07</p>		<p>CITY DRAWING NUMBER</p>		<p>1-0601P-A-M9101-001-000</p>	