

SEWPCC Upgrading/Expansion Conceptual Design Report

SECTION 13 - Hydraulic Profile

Table of Contents

13.0	HYDRAULIC PROFILE	13.1
13.1	INTRODUCTION.....	13.1
13.2	HYDRAULICS BASIC FEATURES AND TERMINOLOGY	13.4
	13.2.1 Hydraulic Head.....	13.4
	13.2.2 Head Losses	13.5
	13.2.3 Other Hydraulic Factors.....	13.6
13.3	FUNCTIONS OF THE HYDRAULIC EVALUATION AND MODELING.....	13.6
13.4	OVERVIEW OF THE SEWPCC.....	13.8
	13.4.1 General Plant Design Layout.....	13.8
	13.4.2 Influent and Headworks Preliminary Treatment	13.8
	13.4.3 Primary Settling Tanks	13.8
	13.4.4 BNR Bioreactors.....	13.9
	13.4.5 Secondary Clarifiers	13.10
	13.4.6 UV Disinfection System.....	13.10
	13.4.7 Plant Bypass Conduit System	13.11
	13.4.8 Outfall Pipeline System	13.11
	13.4.9 General Hydraulic Pathway Profile.....	13.12
13.5	KEY PLANT HYDRAULIC FEATURES AND CONTROLS	13.12
	13.5.1 Flowrate Limits and Flow Routing	13.12
	13.5.2 Recirculation and Extraction Flows	13.14
	13.5.3 Plant Features Affecting Hydraulics	13.14
13.6	DEVELOPMENT OF THE HYDRAULIC MODEL	13.15
	13.6.1 Inputs to the Hydraulic Model.....	13.15
13.7	HYDRAULIC SCENARIOS MODELED	13.20
13.8	MODELING RESULTS	13.21
	13.8.1 Outputs of the Hydraulic Model	13.21
	13.8.2 Example Model Simulation Result.....	13.22
13.9	CONCLUSION	13.25

13.0 Hydraulic Profile

13.1 INTRODUCTION

This section outlines hydraulic evaluation studies for the proposed expansion of the SEWPCC. The hydraulic evaluation studies summarized in this section were performed using InfoWorks® software from Walingford Software.

The SEWPCC was initially constructed over 35 years ago. The existing plant includes High Purity Oxygen Activated Sludge treatment technology to remove organic pollutants, as well as other treatment units. Several upgrades have occurred, including a major upgrade in the 1990s. The goals of the current project include further expansion of the plant capacity and upgrade of the plant treatment systems to accomplish removal of nitrogen and phosphorous. The project includes upgrade of the biological treatment portion of the plant to Biological Nutrient Removal (BNR) technology. The upgrade will be accomplished by eliminating the existing High Purity Oxygen system and constructing the BNR system and other treatment systems.

Average dry weather wastewater influent flowrates for the SEWPCC in recent years has averaged approximately 48 ML/d (million litres per day, or mega-litres per day). Dry weather low flowrate conditions typically occur during the winter. Recent year annual average flowrates have been higher than 48 ML/d and recent wet-weather flowrates have been substantially higher than that value. The design year for the upgrade/expansion is 2031. The annual average flowrate for the expansion / upgrade design is 90.4 ML/d. The upgrade / expansion design addresses wet-weather sewer flowrates up to 415 ML/d, the proposed total capacity of all of the raw wastewater influent pumps.

A summary of key plant influent flowrates is provided on Table 13-1.

Table 13.1 - Summary of SEWPCC Key Flowrates for Hydraulic Evaluations

Plant Influent Flowrates	Existing Plant Hydraulic Capacity	Recent Existing Plant Flowrates	Proposed Plant Design Flowrates
	(ML/d)	(ML/d)	(ML/d)
Dry Weather Flowrate	388 ₍₁₎	46 ₍₂₎	68
Maximum Monthly Flowrate	388	111 ₍₃₎	132
Maximum Daily Flowrate	388	272 ₍₄₎	300
Maximum Hourly Flowrate	388	350 ₍₅₎	415

Notes:

- 1) The maximum installed capacity of the four existing influent pumps is 388 ML/d. The existing firm capacity is 274 ML/d. (TM 25)
- 2) 46 ML/d is the average of January data for the years 1983 through 2003. December data were slightly higher.
- 3) 111 ML/d is the maximum monthly flowrate from 1983 through 2003, and occurred in April 1997.
- 4) 272 ML/d was the maximum daily flowrate from 1983 through 2005, and occurred in 2005 (PDR, Table 4-11).
- 5) (5) 350 ML/d was the maximum hourly flowrate from 1983 through 2005, and occurred in Spring 2005 (PDR Table 4-11).
- 6) Maximum flowrate values shown are indicative of wet weather flow conditions.

For convenience in considering the hydraulic evaluations performed, a copy of the base summary flow diagram of the proposed expanded treatment plant is provided below. This diagram was provided as Figure 24.2 in TM 24.

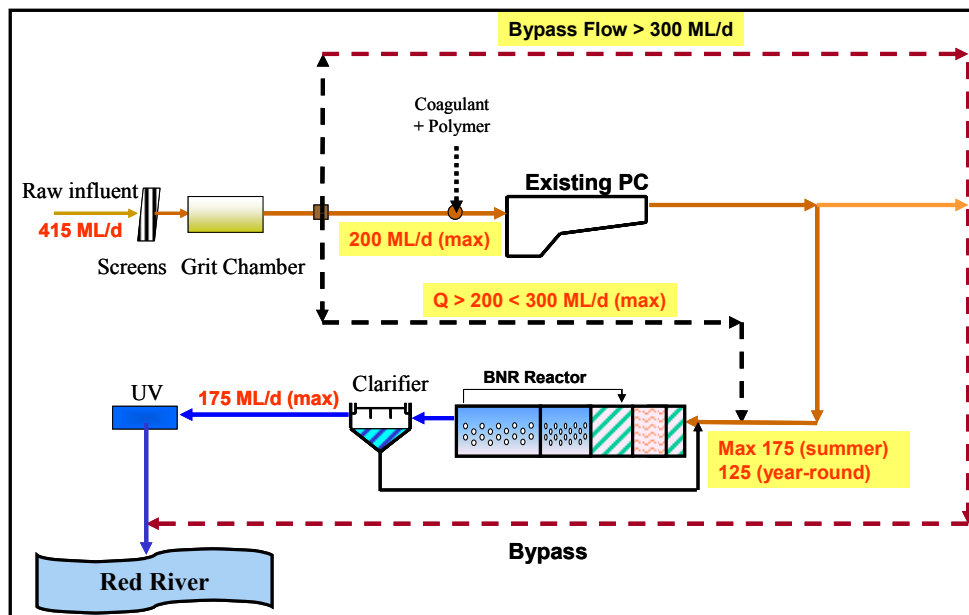

This diagram is intended to provide a general overview of the main plant flow pathways. The flowrate numbers shown represent conditions at projected future peak influent flow conditions. There are many other minor flow pathways in the plant design, and many other flowrate conditions which were evaluated. Further details are provided in the hydraulic evaluation discussion and in other sections of this report.

The upgrade / expansion project includes design capacity targets of 200 ML/d for primary clarification, 175 ML/d for the biological treatment for warm-weather months, and 125 ML/d for biological treatment during cold-weather months.

Within the past 30 years, a number of studies of the SEWPCC have been conducted which have focused at least in part on hydraulics of the treatment plant. Several of those studies have focused on flooding at the plant and on related hydraulic conditions in the plant outfall pipeline and treatment units such as the secondary clarifiers. Study, design reports and operational manuals referenced for this section include the following:

- *South End Water Pollution Control Centre - Functional Design Report*, prepared by MacLaren Engineers and others, September, 1989.
- *SEWPCC Expansion Stage I Evaluation Study - Draft Report*, prepared by Wardrop/MacLaren, December 1993.
- Operating Manuals for various portions of the SEWPCC, prepared during 1993 and 1994, by Wardrop/MacLaren.
- *South End Water Pollution Control Centre - Effluent Disinfection Project - Preliminary, Conceptual, and Functional Design Report*, prepared by Reid Crowther & Partners Ltd and others, July, 1998.
- *South End Water Pollution Control Centre - Effluent Disinfection Facility- Area Manual*, prepared by Reid Crowther & Partners Ltd, March, 2000.

One of the issues upon which previous studies focused was the effect of Red River flood water elevations on the hydraulics of the SEWPCC discharge through the plant outfall pipeline. Several of the previous studies have indicated that during historical high Red River water elevations, the hydraulic grade of the treated wastewater discharge increased through the outfall pipeline and surcharged the secondary clarifier weirs. As outlined below in this section, that situation will be greatly alleviated by the planned partial twinning of the plant Outfall pipeline, as well as by the implementation of the Red River Floodway Expansion Project.

The focus of the hydraulics evaluation conducted during the Preliminary and Conceptual Design has been on the main flow of wastewater through the major SEWPCC wastewater treatment units, including the mixed liquor (ML) which flows from the bioreactors to the secondary clarifiers. A major function of the hydraulic evaluation and design is to confirm that the main wastewater/ML stream, after the influent pumping, will flow through the plant and down the outfall pipeline system into the Red River entirely by gravity. The SEWPCC design includes other recirculation and sidestream flows which will be pumped, such as the return activated sludge (RAS). The hydraulics of those pumping systems and the gravity components of the sidestream and recirculation flows have been estimated to date and will be calculated in detail during the Detailed Design. However, the pumping pressure hydraulics related to the

recirculation and sidestream flows have not been incorporated into the InfoWorks® modeling of the hydraulics for the main wastewater/ML flow through the plant as part of the Preliminary and Conceptual Design. The numerical flowrates of the major recirculation streams such as the RAS have been incorporated into the InfoWorks modeling, represented as input additions and extractions from the total wastewater/ML flowrate.

13.2 HYDRAULICS BASIC FEATURES AND TERMINOLOGY

This section summarizes several of the basic concepts and terms used in hydraulic evaluations for wastewater treatment plants, with particular focus on features included in the SEWPCC.

13.2.1 Hydraulic Head

In this section as in many hydraulics reports, the terms “head” and “hydraulic head” are periodically used to designate the hydraulic energy in the liquid stream at a particular point on its path through the treatment plant. The hydraulic head (sometimes referred to as the Total Dynamic Head) is defined as the sum of the potential energy and the kinetic energy of the liquid at a particular location. The potential energy is sometimes referred to as the static or hydrostatic head. At points where the liquid is flowing in an open-top channel or tank, flowing in a partial-pipe flow condition, or resting still in a channel or tank, the potential energy is indicated by the elevation of the liquid surface. At locations where the liquid is flowing in a completely closed conduit such as a pipe under full-pipe conditions, the potential energy is indicated by the measured pressure of the liquid at that point in the conduit. The potential energy or static head is related to the vertical pull of gravity on the liquid. The kinetic energy of the flowing water is an exponential function of the velocity of the water at the particular point within the plant. Within most large open tanks in wastewater plants, the liquid velocities are generally low enough that the kinetic energy is low in comparison with the static head, such that the total dynamic head (the sum of the static energy and kinetic energy) is only slightly higher than the water surface elevation. In those situations, the water surface elevation serves as a reasonably accurate indication of the total dynamic head at that particular point. This is also true, but to a lesser extent, for open channels. For open channels, with liquid velocities, the total dynamic head is somewhat higher than the liquid surface, and the liquid surface elevation only serves as an approximate indication of the total dynamic head.

A condition that frequently occurs in wastewater treatment plants including the SEWPCC is one in which the liquid in an open tank or open channel typically has its top surface open and in equilibrium with the normal ambient atmosphere. In such conditions, the liquid is considered to have a “free energy surface.” If the gas over above the liquid surface (the “headspace”) is under any pressure condition significantly different than ambient atmospheric pressure, the liquid is not considered to have a free energy surface. Such conditions typically occur in anaerobic digesters, where the headspace gas is maintained at pressures slightly higher than atmospheric pressure. The SEWPCC has anaerobic digesters, while the NEWPCC does not. The SEWPCC design includes several treatment tanks where the headspace may be very slightly different than ambient atmospheric pressure, such as the covered Bioreactors. During the preliminary and conceptual design hydraulic evaluations, these have been considered to be close to free

energy surfaces, as a reasonable approximation. During the final design, these situations will be evaluated in further detail to assess whether the influence of the minor headspace pressure variations should be incorporated into the analysis of plant hydraulics.

When considering a point below the surface of a liquid in an open tank or channel, the pressure of the liquid at that depth is considered the “hydrostatic head” or “hydrostatic pressure.” This is not a major focus of the main wastewater/ML stream hydraulics evaluation, but will be addressed during the final design for certain sidestream components when finalizing pumping system and controls design.

13.2.2 Head Losses

As the wastewater/ML liquid flows through the treatment process, the liquid will lose energy due to friction losses, velocity-related molecular turbulence, and/or impact energy loss through water molecule collision with hard surfaces. Examples of points where the wastewater/ML will undergo head losses include:

- Flow through all treatment plant component vessels, by friction of water molecules against the wall surfaces of the vessels (tank, pipe, etc.), varying in part as a function of the roughness of the vessel wall surface material.
- Flow through narrow constructions such as small window ports, including both entry (constriction) losses and exit losses.
- Flow through sluice gate openings even in the open position, due to roughness of the gate frames.
- Flow through bends in channels, piping, or other conduits.
- Flow through conduit sections that include dimensional contractions or expansions.
- Flow through screens.
- Flow through media packing (negligible in many cases).
- Flow through gates or valves which are designed to throttle the flowrate by varying the percentage of opening.
- Flow over sharp-edged weirs, due to friction; (however, the drop in liquid level downstream of a weir is addressed as a separate function).

The InfoWorks® software provides for selection of specific codes and input values to address all of the types of head losses outlined above.

For weirs, the overall liquid surface elevation profile is evaluated along a pathway including backwater from down gradient features as well as the flow over the weir. If that profile results in

a condition where the flow over the weir occurs as a spout which is broken free from the downstream face of the weir and which splashes into the downstream liquid, the weir is considered to have an “aerated nappe” and the water level in the tank immediately upstream of the weir (e.g. a clarifier) is dependent only on the magnitude of the flowrate and the details of the weir geometry. In such conditions, it is considered that there is a free energy break at the weir, reflecting a discontinuity in the hydraulic grade. However, a situation may develop at a weir location in which the water level due to downstream effects either submerges the weir or approaches the weir crest elevation and eliminates or prevents the formation of an aerated nappe over the weir. In such cases, the water level in the tank or vessel immediately upstream of the weir is dependent not only on the magnitude of the flowrate and the weir details, but also on the hydraulic conditions farther downstream of the weir. In such cases, it is considered that there is full hydraulic connectivity along the pathway involving the weir. The hydraulics computational methods used for the SEWPCC evaluation addresses both of these conditions, using a different weir formula for the two different types of weir conditions.

13.2.3 Other Hydraulic Factors

There are other factors which affect the hydraulics, primarily related to sidestream conveyance and pumping systems. These include the density and viscosity of materials such as primary and secondary sludges, scum, and liquid chemicals; which are different from the values used for wastewater and ML. The potential to have laminar flow as compared with turbulent flow conditions for certain treatment plant areas is another factor. The potential occurrence of hydraulic jumps at transitions between subcritical and supercritical flow conditions is another factor. These factors will be reviewed in detail and addressed subsequently as part of the Detailed Design.

13.3 FUNCTIONS OF THE HYDRAULIC EVALUATION AND MODELING

The functions and purposes of the hydraulic evaluation included the following:

- To provide confirmation that the proposed upgraded treatment plant will have the hydraulic capacity to handle the design flowrates.
- Through the hydraulic model, to provide a tool that can be used for design refinement during detailed design, and for future operational purposes.

The evaluation approach included the following major steps:

- Review of drawings and measurements of the existing plant.
- Review of historical hydraulic conditions at the existing plan.
- Review of design flowrate development documentation.
- Preparation of a computer hydraulic model of the existing plant, using InfoWorks® software.

- Calibration of the computer model by comparing actual plant water level measurements with model predictions for a specific flowrate; adjust settings in the model to make it match reality.
- Expansion of the hydraulic model to incorporate the proposed upgrade modifications – add the design features of the modifications.
- Incorporation of plant flow split algorithms addressing wet weather flow management procedures, with key triggers at 125, 175, 200, and 300 ML/d values (influent or internal).
- Simulation of runs with the expanded model to simulate key hydraulic loading conditions at the proposed expanded plant.
- Development of feedback to design team for any required adjustments.
- Repeat simulations as necessary for design revision.

The plant model to date has been run in steady-state mode. Key premises adopted in the development and execution of the hydraulic modeling and evaluation included the following:

- The InfoWorks® model only addresses the wastewater liquid stream hydraulics, with appropriate recycle inputs to that liquid stream. (All plant streams including solids streams and chemical feed streams are modeled or calculated as part of Detailed Design).
- At this time, the treatment plant model is not coupled with hydraulic modeling of the influent interceptor sewer.
- No overflow is considered acceptable for the plant.
- The plant model upper hydraulic boundary has been established at the influent grit channels - influent pumps separate.
- The hydraulic model to date has analyzed key influent flowrates ranging from 20 ML/d to 422 ML/d. The low value represents an hourly low flow, and the high value represents the projected maximum influent flowrate plus recycle streams.

Particular features of the InfoWorks® hydraulic modeling software include the following:

- InfoWorks® provides a comprehensive multiple-pathway energy balance to arrive at a coherent solution for water hydraulic grade and water surface elevation.
- The model is constructed as a diagram involving “Nodes,” and “Links” between the Nodes.
- Links are considered as Conduits, and may be coded as being sealed (for pipes) or unsealed (for open channels).

13.4 OVERVIEW OF THE SEWPCC

13.4.1 General Plant Design Layout

A general plan view of the plant design layout is shown on Figure 13.1. An overview description of the SEWPCC, including the general hydraulic features, in the proposed upgraded and expanded condition, is provided below.

13.4.2 Influent and Headworks Preliminary Treatment

Wastewater from the Winnipeg collection system flows by gravity through the main interceptor sewer into the wet well of the influent pumping station at the plant. There are four influent raw wastewater pumps. The influent pumps lift the raw wastewater and discharge it into the plant headworks, which include screening and grit removal chambers and equipment. From the headworks, the main wastewater stream flows by gravity through all subsequent treatment systems at the plant.

The SEWPCC design includes controls to limit the flowrate into the existing two gravity grit settling chambers to 200 ML/d (100 ML/d per chamber). The maximum flowrate that will be sent through the existing grit chambers and the Primary Settling Tanks (PST) is 200 ML/d. Influent flows in excess of 200 ML/d will be diverted and sent through the two new vortex grit chambers, fine screens, and to the Plant bypass line. This diverted flow is considered to be the primary bypass stream. The flow splitting will be accomplished by manipulation of weirs and gates at the grit influent channel area.

Historical drawings and reports indicate some features in the headworks area that do not match apparent current conditions, based on initial examination by Stantec personnel. This includes indications on earlier plans and reports of the weirs and sluice gates in the vicinity of the initial coarse screen channels. It is recommended that during the Detailed Design phase, a comprehensive examination, measurement and review be conducted with City operational personnel to confirm the exact details of all existing features that will remain in place through the SEWPCC upgrade/ expansion project; and that further modeling be performed if necessary to refine the hydraulic evaluation to accurately reflect those conditions.

13.4.3 Primary Settling Tanks

Wastewater flows from the gravity grit chambers through channels into the PSTs. In the PSTs, a significant portion of the solids which are in suspension in the dewatered raw wastewater are removed by gravity settling. There are three PSTs, which operate in parallel. They are rectangular in plan shape. Wastewater enters the front end and exits the downstream end of the PSTs. Solids settle to the bottom of the settling tanks and are removed as primary sludge by scrapers, conveyors and pumps. Scum is also removed from the surface of the PSTs. The clarified wastewater discharges over weirs at the downstream end of the PSTs to flow as primary effluent toward the BNR bioreactors. As explained below, under certain conditions, a portion of the primary effluent may be diverted from entering the BNR bioreactors.

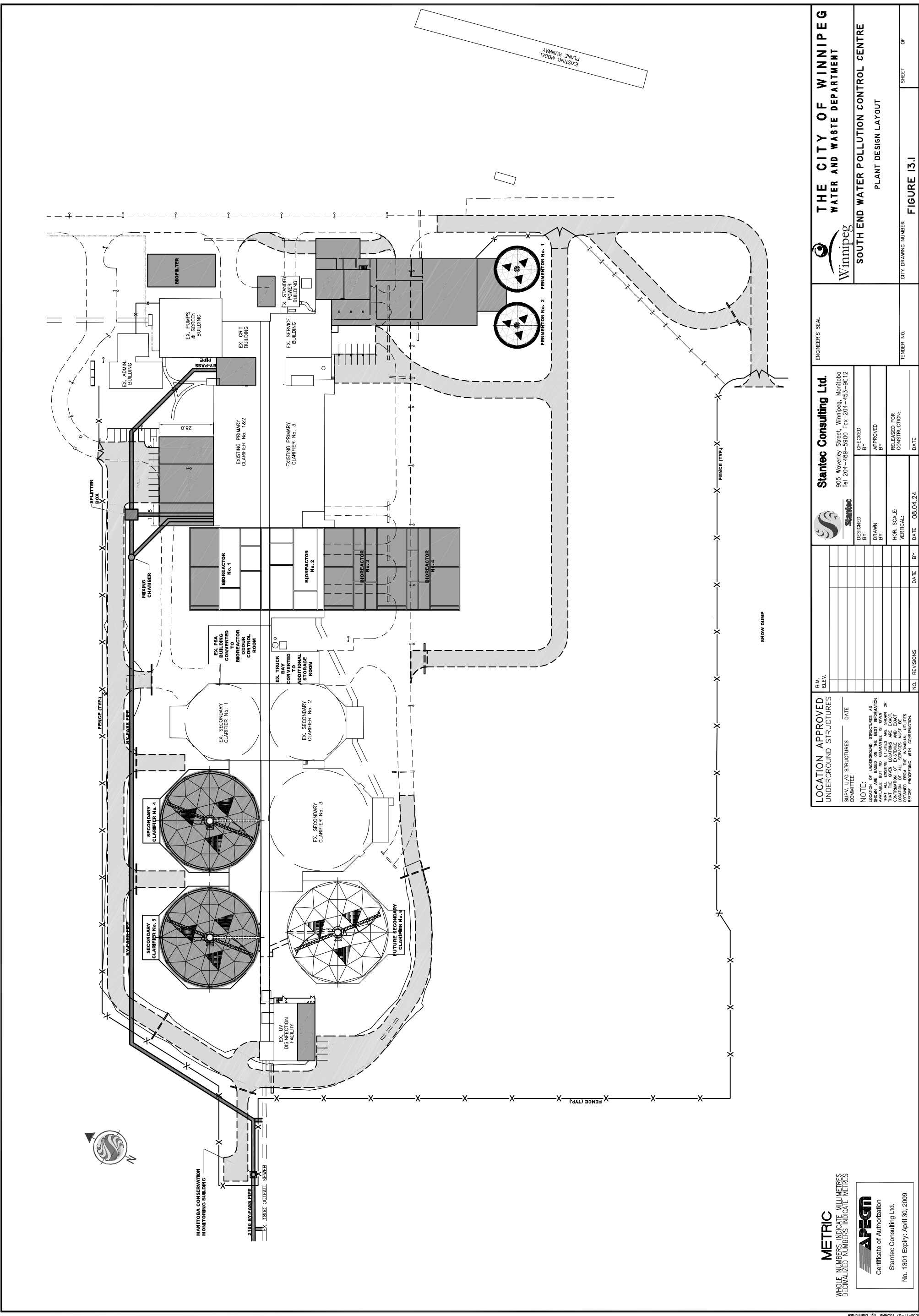

THE CITY OF WINNIPEG
WATER AND WASTE DEPARTMENT
SOUTH END WATER POLLUTION CONTROL CENTRE
PLANT DESIGN LAYOUT
FIGURE 13.1

ENGINEER'S SEAL
 TENDER NO. _____
 SHEET _____ OF _____

Stantec Consulting Ltd.
 905 Moyerley Street, Winnipeg, Manitoba
 Tel 204-489-5900 Fax 204-453-9012

NO.	REVISIONS	DATE	BY

LOCATION APPROVED UNDERGROUND STRUCTURES
 SUPV. U/G STRUCTURES COMMITTEE DATE
 NOTE: LOCATION OF UNDERGROUND STRUCTURES AS SHOWN ARE FOR INFORMATION AVAILABLE BUT NO GUARANTEE IS GIVEN THAT ALL EXISTING UTILITIES ARE SHOWN OR THE LOCATION OF ALL SERVICES MUST BE CONFIRMED BY THE EXISTENCE AND EXACT LOCATION OF ALL SERVICES MUST BE CONFIRMED BEFORE PROCEEDING WITH CONSTRUCTION.

DESIGNED BY	CHECKED BY	DATE

METRIC
 WHOLE NUMBERS INDICATE MILLIMETRES
 DECIMALIZED NUMBERS INDICATE METRES

APEGM
 Certificate of Authorization
 Stantec Consulting Ltd.
 No. 1301 Expiry: April 30, 2009

13.4.4 BNR Bioreactors

The settled wastewater from the PSTs (primary effluent) flows by gravity through a distribution channel and piping to the BNR bioreactors. The BNR influent channel is an elevated trough which receives the primary effluent. The BNR bioreactors will also receive any primary bypass flow which may be split off from the Plant bypass line to receive biological treatment, depending on the overall plant flowrates and on the available BNR bioreactor capacity. In warm weather months, the plant controls will be set to allow up to 175 ML/d of total flow to be sent to the BNR bioreactors. During cold weather months, the BNR influent will be limited to a maximum of 125 ML/d. Primary effluent will be conveyed from the BNR influent channel to each of the BNR bioreactors through four sets of piping connections, which will draw wastewater from the bottom of the BNR influent channel. Each of the four connecting piping runs will include a flowmeter and a throttling valve, which will be programmed to balance the BNR influent flow appropriately among all of the active BNR bioreactors. The general target for this flow control system will be to limit the total wastewater flow to the BNR system to 125 ML/d in cold weather months and 175 ML/d in warm weather months. The specific control settings to meet those targets will be developed during Detailed Design, and will be further refined during plant operations as additional data on hourly flowrate variability accumulates over time. The primary effluent throttling valves represent points of key hydraulic control in the treatment plant.

During high wet weather events with plant flow greater than 200 ML/d, some of the degrittled primary bypass flow from the Plant bypass line will be diverted to the BNR bioreactors, with flowrate control. To accomplish that, a pipe will extend from a flow splitter structure on the Plant bypass line to the influent side of the BNR bioreactors, where it will split into four branches, one feeding each bioreactor through a flowmeter and a throttling valve. This flow control system, located at the influent side of the BNR bioreactors, will necessitate control weirs or other flow control devices at the flow splitter structure to be located on the Plant bypass line. The controls will be set to limit the maximum flowrate of degrittled primary bypass flow to the BNR bioreactors to 100 ML/d (total for all bioreactors). Any degrittled primary bypass flow which is greater than this flowrate will continue flowing down the Plant bypass pipeline toward the outfall pipeline system.

The SEWPCC design incorporates provisions to divert some of the primary effluent around the BNR bioreactor system to the Plant bypass pipeline. This will be accomplished by a diversion pipe that will be connected to the bioreactor influent channel near the north end of the channel. The primary effluent diversion pipe will drop from the bottom of the channel. There will be a throttling valve on the primary effluent diversion pipe that will be controlled through the new plant control system to prevent unwanted drainage of the primary effluent to the Plant bypass line. This control system will ensure that the intended amount of primary effluent is conveyed into the bioreactors and that any excess primary effluent greater than that amount gets drained to the Plant bypass line. The primary effluent diversion pipe will extend in buried condition northward through the yard, and will connect to the Plant bypass pipeline at a junction structure at a point downstream of the Primary bypass splitter structure. It will not be necessary to have any flow control devices at the junction structure on the Plant bypass pipeline.

The new facility will include four parallel bioreactors trains. In the bioreactors, the wastewater will undergo a series of biochemical transformations through which most of the dissolved materials in the wastewater are converted to solid material consisting of a mixture of microbial cell material and some precipitated inorganic solids. The mixture of these solids in suspension in the dilute solution of the remaining dissolved organic and inorganic chemicals is defined as ML. The bioreactors are designed to accomplish biological nutrient removal, including removal of nitrogen and phosphorous from the wastewater. In the bioreactors, the wastewater will flow through a series of different compartments including anaerobic, anoxic, and aerobic conditions. The aerobic zones are supplied with diffused air from blowers. Mixing is provided in several of the zones. The last aerobic zones contain submerged media that provide surfaces for the growth of fixed-film microbial populations, representing the Integrated Fixed-film Activated Sludge (IFAS) feature of the treatment in progress. In passing through the bioreactors, the wastewater flows over a series of weirs and through window ports in the partition walls that separate the different zones. The wastewater (the ML) leaves the last aerobic zones through a set of screens that prevent the IFAS media from being washed out of the bioreactors. The ML then flows through a bioreactor effluent channel and on through piping to the secondary clarifiers.

In the BNR bioreactor system, the weirs between compartments and the final exit screens represent important hydraulic head loss features. The media in the IFAS zones represent a lesser hydraulic head loss feature.

13.4.5 Secondary Clarifiers

The ML flows from the bioreactors through a series of channels and conduits into the secondary clarifiers (or final clarifiers). The expanded plant will include five secondary clarifiers, circular in plan shape, which will operate in parallel. The ML enters the secondary clarifiers through piping and a central feed column conduit on each clarifier. The ML then radiates outward through the body of each clarifier to a circular ring of elevated overflow weirs at the perimeter of each clarifier. Solids settle by gravity to the floor of the clarifiers and are removed as secondary sludge. The clarified wastewater flows over the weirs into effluent channels and conduits. At this point in the treatment process, the treated wastewater is referred to as secondary effluent or biological treatment effluent. It will travel to the UV disinfection system.

13.4.6 UV Disinfection System

Effluent from the secondary clarifiers will flow through the effluent channel to the ultraviolet (UV) disinfection structure, which will be an expansion and modification of the existing UV system. This will consist of a rectangular structure with several parallel channels. Four channels will contain UV lamps. One channel without lamps will serve as a bypass pathway. The overall UV disinfection structure includes a distribution channel that branches to each of the four parallel UV lamp channels. At the end of the UV lamp channels, there is a junction channel which recombines the branched flows into a single outlet from the UV disinfection structure, including any flow that has bypassed the UV lamp channels. The flow then exits the UV disinfection structure and enters the outfall pipeline system.

The UV disinfection structure is being designed to limit the flow through the UV lamp channels to 175 ML/d or less. This will be accomplished by use of a weir on the bypass channel and sluice gates which will distribute the flow in the desired manner.

13.4.7 Plant Bypass Conduit System

The general overall direction of flow through the SEWPCC is from northeast to southwest.

In addition to the major treatment stages, the SEWPCC design also incorporates a series of bypass points, as outlined above. These serve to divert a portion of the wastewater flow around certain stages of treatment during times when the influent flows to the plant are high due to wet weather. A series of diversion structures and junction structures in the plant serve to divert flow to the bypass conduit and under certain conditions to direct bypassing flow back into the treatment system. The plant bypass conduit has a design diameter of 2,100 mm.

13.4.8 Outfall Pipeline System

The section of the outfall pipeline system that is immediately downstream of the UV disinfection system consists of a single buried circular pipe, which carries the effluent in a southwesterly direction heading to the outfall point on the Red River.

A short distance downstream along the outfall pipeline from the UV disinfection system, the Plant bypass conduit will join the outfall pipeline at a junction manhole structure. Several metres downstream of that point, a splitter structure splits the flow from the single outfall pipeline to two twinned outfall pipelines. That structure will also serve as a monitoring chamber. The twin pipelines run in parallel for several hundred metres until re-joining again into the final single-pipe outfall segment that discharges to the Red River. The outfall pipeline diameter is 1,800 mm in the final segment.

The final single outfall pipeline has an invert elevation of +218.542 m at the point of discharge to the Red River. This is an elevation that is frequently submerged by the elevation of the river water. Based on historical records, the Red River at the SEWPCC Outfall discharge locations has a 50-year return period water elevation of +229.80 m. For comparison, the design floor elevation of the chamber at the end of the UV disinfection structure is +229.05 m. As noted elsewhere, it is estimated that the probability of the Red River again reaching an elevation of +229 m at the outfall location is very low.

The invert elevation of the main trunk sewer at the point where it enters the wet well of the SEWPCC influent pump station is +219.61. The invert elevation of the influent pump station wet well is +216.05. The invert elevation of the screen channel which receives the discharge of the influent pumps is +232.87 m. Thus, there is a total drop in invert elevation from the plant influent screen channel to the end of UV disinfection structure of 3.82 m (232.87 m – 229.05 m). This provides a general idea of the overall grade available through the treatment process at the SEWPCC.

13.4.9 General Hydraulic Pathway Profile

A simplified profile drawing that follows the pathway of the wastewater flow through the main treatment units of the SEWPCC in the upgraded and expanded condition is shown in vertical cross-section view on Figure 13.2.

13.5 KEY PLANT HYDRAULIC FEATURES AND CONTROLS

13.5.1 Flowrate Limits and Flow Routing

The design for the SEWPCC upgrade/expansion incorporates a specific set of bypass trigger flowrates for different portions of the year. These trigger values incorporate the following premises:

- a) All influent flows will pass through the coarse (12 mm) screens.
- b) The maximum flowrate sent through the existing aerated grit chambers will be 200 ML/d.
- c) Influent flows in excess of 200 ML/d will be diverted from entering the existing aerated grit chambers, and will be sent through the new vortex grit collection system and new 6 mm fine screens.
- d) In cold weather months, the maximum flowrate sent through the biological treatment system (the bioreactors and the secondary clarifiers) will be 125 ML/d. Flows in excess of that value during cold weather months are bypassed around the secondary treatment system.
- e) In warm weather months, the maximum flowrate sent through the biological treatment system will be 175 ML/d. Flows in excess of that during warm weather months will be bypassed around the secondary treatment system.
- f) The maximum flowrate sent through the PSTs will be 200 ML/d. Influent flows in excess of 200 ML/d will be diverted around the PSTs.
- g) The maximum flowrate sent through the ultraviolet (UV) disinfection system will be 175 ML/d. Flows in excess of that value will be diverted around the UV system.
- h) For high influent flowrates during wet weather, treatment bypass routing will be performed in a manner to minimize the amount of flow that does not receive either primary settling or biological treatment with secondary clarification.
- i) For the range of high influent flowrates in excess of 200 ML/d, which is the maximum capacity of the PSTs, up to 300 ML/d, treatment bypass routing will be done in accordance with the following general operational rules:

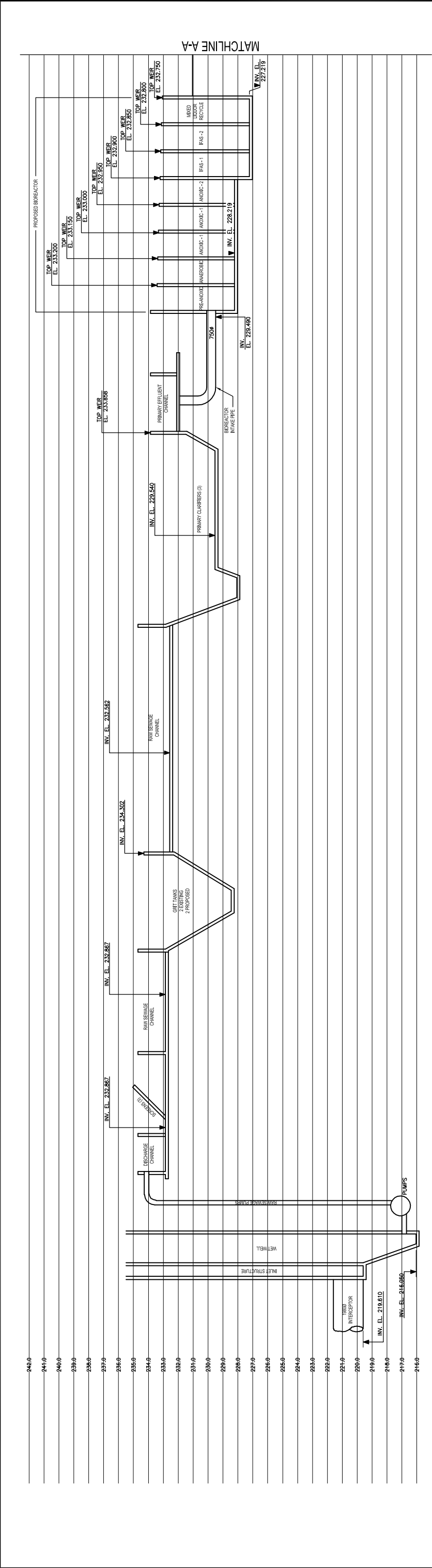

MATCHLINE A-A

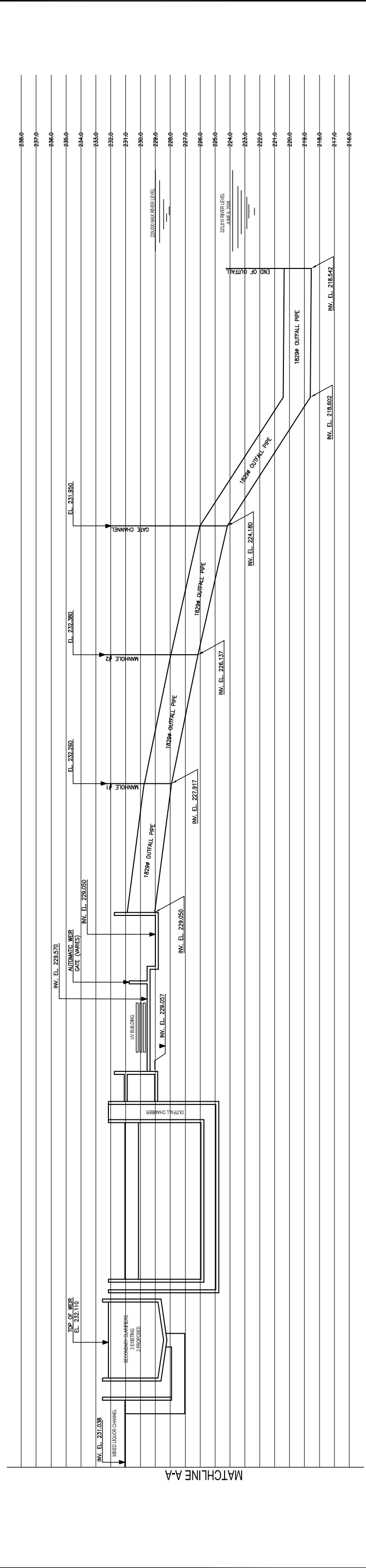

MATCHLINE A-A

LOCATION APPROVED UNDERGROUND STRUCTURES

SUPV. U/G STRUCTURES _____ DATE _____

COMMITTEE _____

NOTE: UNDERGROUND STRUCTURES AS SHOWN ARE BASED ON THE INFORMATION AVAILABLE BUT NO GUARANTEE IS GIVEN THAT ALL EXISTING UTILITIES ARE SHOWN OR LOCATION OF ALL SERVICES MUST BE CONFIRMED BY A PROFESSIONAL ENGINEER BEFORE PROCEEDING WITH CONSTRUCTION.

Stantec Consulting Ltd.
 905 Waverley Street, Winnipeg, Manitoba
 Tel. 204-489-5900 Fax. 204-453-9012

DESIGNED BY _____

DRAWN BY _____

CHECKED BY _____

APPROVED BY _____

AS NOTED FOR CONSTRUCTION

DATE 2008.11.03

ENGINEER'S SEAL

THE CITY OF WINNIPEG
 WATER AND WASTE DEPARTMENT

SOUTH END WATER POLLUTION CONTROL CENTRE

SIMPLIFIED PLANT HYDRAULIC CROSS - SECTION

CITY DRAWING NUMBER _____ TENDER NO. _____

FIGURE 13.2 SHEET _____ OF _____

NOTES:

1. NEW VORTEX GRIT CHAMBERS NOT SHOWN, FOR CLARITY.
2. BY-PASS CONDUITS ARE NOT SHOWN
3. WATER LEVEL PROFILES ARE SHOWN ON OTHER FIGURES.

1. 200 ML/d, after degritting and screening, will be sent to the PSTs.
 2. The excess portion of the influent flow which is over 200 ML/d, after degritting and screening, will be routed via the Plant bypass line around the PSTs; this bypass flow will consist of excess flows ranging between 0 ML/d and 100 ML/d.
 3. All of the primary bypass flow (which will range between 0 and 100 ML/d) will be subsequently split back from the Plant bypass line and will be sent to the BNR bioreactors.
 4. A portion of the flow which has passed through the PSTs (the primary effluent) will be routed to the BNR bioreactors; up to the point where the total flow routed to the BNR bioreactors (including primary effluent and primary bypass flows) does not exceed its seasonal limit (175 ML/d in warm weather and 125 ML/d in cold weather). The remaining portion of the primary effluent will bypass biological treatment (the BNR bioreactors and the secondary clarifiers) and the UV disinfection system and will blend back in with the treated and disinfected flow to enter the outfall pipeline.
- j) For the range of high influent flowrates in excess of 300 ML/d (up to 415 ML/d), treatment bypass routing will be done in accordance with the following operational rules:
1. 200 ML/d, after degritting and screening, will be sent to the PSTs. All of this flow will bypass secondary treatment and UV disinfection.
 2. The excess portion of the influent flow which is over 200 ML/d, after degritting and screening, will be routed via the Plant bypass line around the PSTs; this primary bypass flow will range between 0 ML/d and 215 ML/d.
 3. Of the total primary bypass flow, a portion will be subsequently split back from the Plant bypass line and will be sent to secondary treatment, up to the maximum seasonal capacity of the secondary treatment system. During warm months, that portion will range between 0 and 175 ML/d, and in colder months will range between 0 and 125 ML/d.
 4. A portion of the flow that has passed through the PSTs (the primary effluent) will be routed to the BNR bioreactors; up to the point where the total flow routed to the BNR bioreactors (including primary effluent and primary bypass flows) does not exceed its seasonal limit (175 ML/d in warm weather and 125 ML/d in cold weather). The remaining portion of the primary effluent will bypass biological treatment and the UV disinfection system and will blend back in with the treated and disinfected flow to enter the outfall pipeline.

13.5.2 Recirculation and Extraction Flows

The SEWPCC design incorporates several recirculation and extraction flows. These streams affect the hydraulics of the main wastewater/ML stream flowing through the plant to varying degrees. Recirculation and extraction streams include the following:

- Withdrawal of primary sludge from the PSTs flowing to the fermenters (a moderate/minor flow).
- Input of fermentate from the fermenters into the bioreactor system (a minor flow).
- Internal recirculation of ML within the bioreactor system (a major flow).
- Recirculation of RAS from the bottom of the secondary clarifiers back to the bioreactor system (a major flow).
- Withdrawal of Waste Activated Sludge (WAS) from the bioreactor final ML discharge; which will be sent to the Dissolved Air Flotation (DAF) system (a moderate/minor flow).
- Return of DAF Subnatant to the PSTs (a minor flow).
- Extraction of elutriation water from the secondary clarifier effluent (a minor flow).
- Removal of dewatered sludge from the DAF system through the sludge storage tanks and truck hauling (an insignificant volumetric flowrate).

Some of the above flows have an effect low enough in comparison with the main wastewater/ML flow and the major recirculation flows that they are ignored during the initial hydraulics modeling.

The InfoWorks® modeling performed to date as summarized in this technical memorandum has not modeled the pumping for the recirculation and extraction streams which are pumped; but has incorporated flow inputs into the main wastewater/ML stream and major extractions from the main wastewater/ML stream at the appropriate locations. Conceptual pumping system hydraulic calculations have been separately performed for each of the recirculation and extraction streams, and are included with the Conceptual Design documentation for the respective areas of the plant.

13.5.3 Plant Features Affecting Hydraulics

The SEWPCC design incorporates a number of physical features throughout the plant that affect the hydraulics of the main wastewater/ML flow. These include:

- Sluice gates throughout the plant. These provide flow pathway routing control by means of opening or closing. The gate frames, even with the gates fully open, represent minor head losses.

- Valves of several types, used for flow routing and control in piping. In the fully open position, these typically represent relatively minor head losses. As the degree of closure increases, the head loss increases. At several points in the plant, the design includes the use of valves to throttle the flowrate. This will occur on the inlet piping of the primary effluent to the BNR bioreactors and on inlet piping of the primary bypass flow to the BNR bioreactors.
- Screens, representing relatively significant head losses, depending on the screen opening dimension and degree of clogging assumed. Screens will exist in the raw wastewater influent channels (coarse screens), in the high flow channels just downstream of the new vortex grit chambers (coarse screens), and at the exit of the IFAS tankages of the four BNR trains to contain the IFAS media (coarse screens).
- Weirs at several locations, including the existing grit chambers, the PSTs, several points within the BNR bioreactor trains at the compartment partition walls separating different zones, the secondary clarifiers, and the bypass channel of the UV disinfection structure.
- Fixed window ports between treatment unit compartments, such as the bioreactor compartments; representing minor head losses.
- Bends in channels and piping, generally representing relatively minor head losses. Long-radius bends will be used at critical points in piping. Channel corners will be rounded to minimize losses.

In addition, as indicated in an earlier section, head loss will develop due to surface friction effects of the liquid flowing through piping, channels, and tanks.

The computer modeling has included selection and entry of coding values to represent all of these types of losses for the SEWPCC hydraulic model.

13.6 DEVELOPMENT OF THE HYDRAULIC MODEL

13.6.1 Inputs to the Hydraulic Model

Inputs to the InfoWorks® hydraulic model included:

- Creation of an array of model nodes and links (conduits) for the SEWPCC plant; and entry of related information including sizes and lengths of conduits, and locations and features of nodes. For the SEWPCC project, the nodes and links were input using actual field survey locational and elevation data sets, supplemented with information taken from City of Winnipeg historical plans.
- Location and dimensional details for gates, screens, pumps, and other features.
- Elevations of chamber overflow rims and floor elevations potentially susceptible to overflow, and desired freeboard dimensions.

- Gate settings for each influent flowrate and flow routing scenario.
- Friction and velocity head loss factors for conduit wall surfaces, orifice entry ports, orifice exit ports, gates, screens, bends, and other devices.

The InfoWorks® software was originally developed for computer evaluation of the hydraulics of sanitary sewer and storm drainage systems, as well as combined sewer systems; and was subsequently adapted for the hydraulic evaluation of treatment plants. Because of that history, the InfoWorks® software has a number of features that are related strictly to sewerage and drainage modeling, such as definition of storm precipitation catchment features, assignment of pipeline infiltration rates, and definition of temporary surface ponding at sewer backup locations. For the evaluation of the SEWPCC hydraulics, Stantec disabled or ignored some of the features of InfoWorks® that relate only to sewer systems and not to treatment plants.

The InfoWorks® software allows for modeling of both steady-state hydraulic conditions as well as for variable-flowrate hydraulic conditions. The software is moderately complex to apply for steady-state conditions for treatment plants, and more complex and time-consuming to apply for variable-flowrate conditions. For this reason, the hydraulic modeling for the SEWPCC was completed using steady-state flow conditions, with incremental plant influent flowrate steps entered in separate simulations, up to the maximum possible influent pumping capacity. Since the SEWPCC will normally be operated with treatment units full (i.e. no batch fill treatment units), and because a hydraulic surface wave passes through the plant quickly compared with the rate of change of plant influent flowrate from the sewer system, it is believed that the incremental flowrate step approach is a valid modeling approach for the SEWPCC. Additional focused modeling will be done during Detailed Design. Variable-flowrate analysis may subsequently be applied for focus on specific issues, such as optimizing the influent pumping from the raw wastewater pump station wet well.

The model inputs included the proposed new bypass conduit and partial outfall twinning. To assess potential high water levels, one scenario was run for Red River at elevation +229 m with a plant flowrate of 300 ML/d). The water elevation of +229 m represents a historical high flood elevation for the Red River in the vicinity of the outfall discharge. The return period of the river water reaching the elevation of 228.70 m in the area of the outfall is once every 33 years.

A print from the InfoWorks® model of the nodes and links diagram that was developed for the SEWPCC project is provided as Figure 13.3. This figure is intended only to provide a general overview of the physical configuration of the hydraulic model developed. This diagram and the other model diagrams presented in this report are oriented with true North at the top of the image. The cluster of nodes near the center of Figure 13.3 diagram represents the treatment plant. The long link in the upper (northern) section of the diagram represents the influent trunk sewer which feeds the plant pump station wet well. It does not represent the entire sewer system. The long extension in the lower left (southwest) portion of the diagram represents the outfall pipeline system, including an initial twinned section and the final single pipe section which discharges to the Red River.

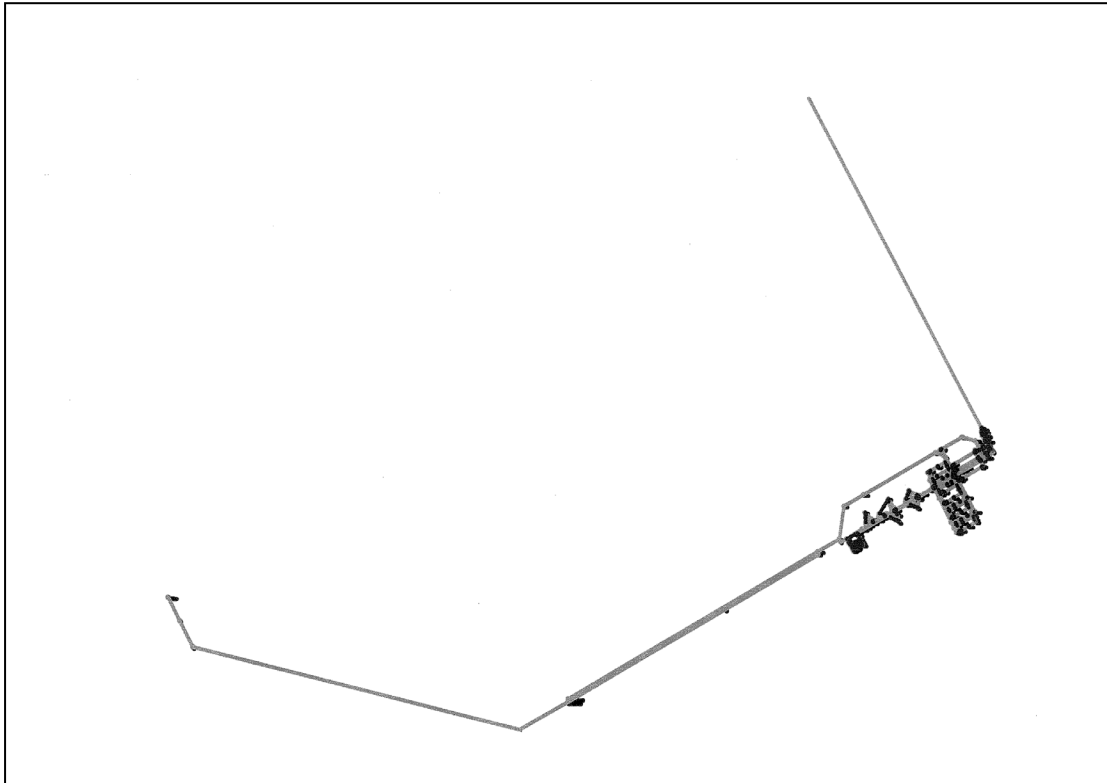

Figure 13.3: Model Input – Entire Nodes and Links Diagram

Figure 13.4 shows an expanded view of the portion of the model nodes and links diagram that covers the main treatment units of the SEWPCC, in the upgraded and expanded configuration as currently proposed. The influent pumping station and headworks are indicated on the upper right (northeast). The BNR bioreactors are in the center right area. To the southwest of the bioreactors are the secondary clarifiers and the UV disinfection system. The central axis of the plant that runs from northeast to southwest includes the mixed liquor channel between the bioreactors and the secondary clarifiers, and the secondary effluent. The line to the north and parallel to the main plant axis is the plant bypass conduit, which includes a series of junction structures and splitter structures. The plant Bypass conduit rejoins the treated effluent line downstream of the UV disinfection system, to flow further southwest through the outfall pipeline.

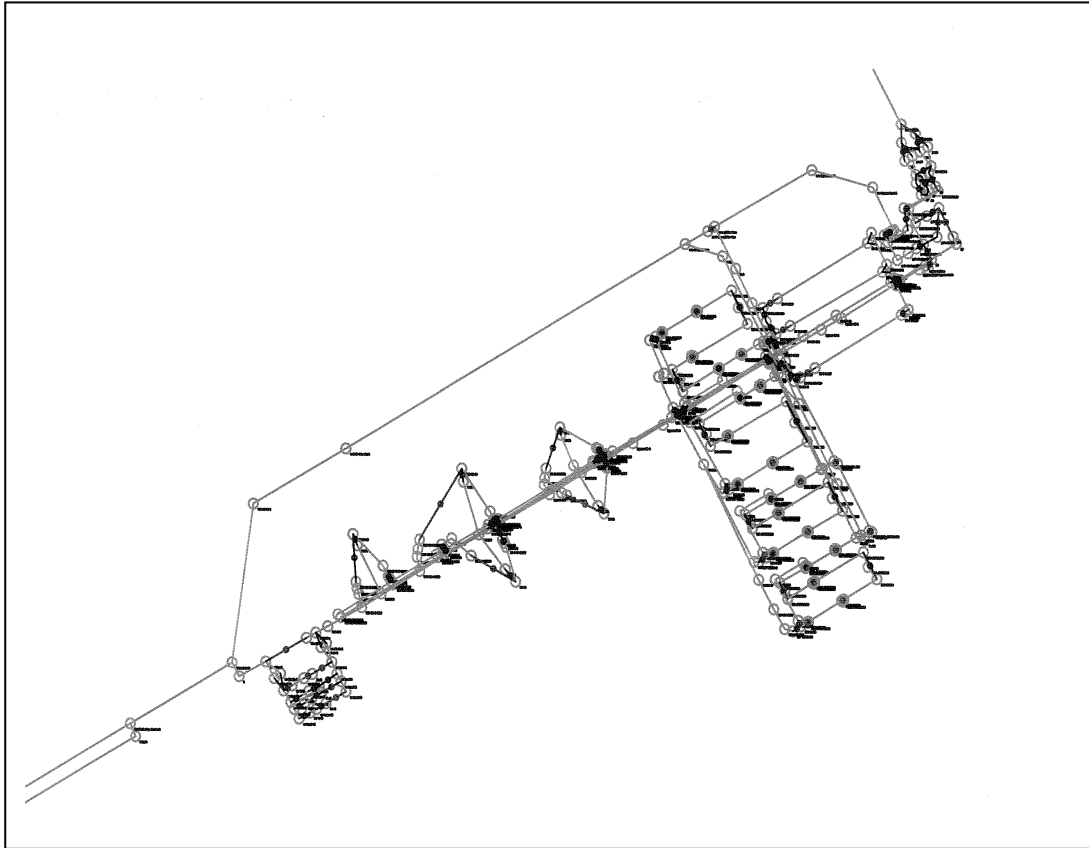

Figure 13.4: Model Nodes and Links Diagram Treatment Plant Overview

Figure 13.5 is an enlargement of the model diagram focusing on the BNR bioreactor system, indicating the four parallel BNR trains. The mixed liquor from the bioreactors is shown combined through the common channel to flow to the secondary clarifiers. Sluice gates and valves, as well as weirs, are displayed as elements positioned between link segments. The links, which appear as single lines on the diagram, are coded to represent pipelines, open channels, and tanks (basins).

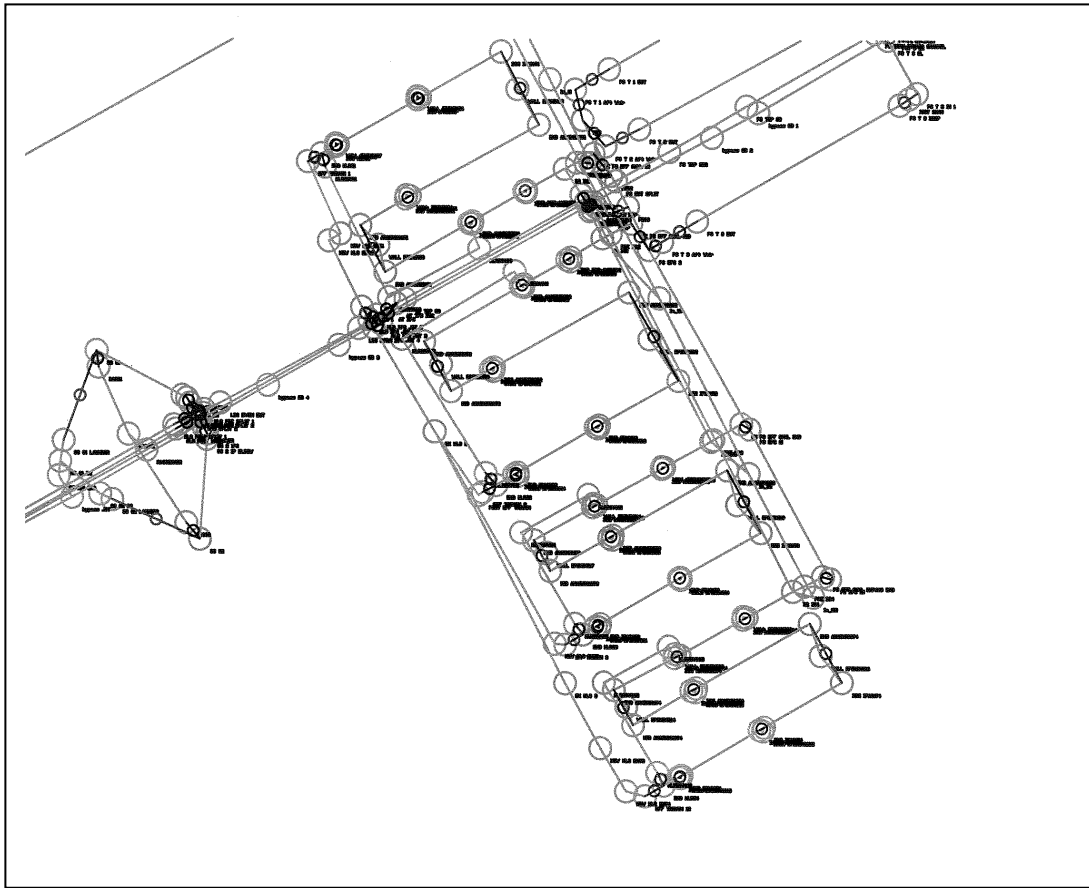

Figure 13.5: Model Input – Nodes and Links – Bioreactor Area

Influent flow from the PSTs will enter the four bioreactor trains by passing through a flow distribution channel and four flowmeters. Each of the four bioreactor trains will have separate compartments for pre-anoxic, anaerobic, anoxic-1, anoxic-2, aerobic-1, aerobic-2, and final mixed liquor recycle zones. Flow through the compartments in each train will involve passage through wall ports and over weirs. The aerobic compartments will be partially filled with media for the Integrated Fixed-film Activated Sludge (IFAS) function. The flow will exit the IFAS zones through screens. Mixed liquor from the final compartment will be locally pumped and recycled back to the anoxic-1 compartment. Return Activated Sludge (RAS) will be recycled back from the secondary clarifiers back to the bioreactors. Fermentate will be conveyed from the fermenters to the bioreactors. Each of these features and design elements is coded into the InfoWorks® model, with type codes entered to differentiate between open conduits and pressurized conduits (e.g., pipes),

To provide an indication of the degree of detail that the model incorporates, an expanded window of a small portion of the model, focusing on the UV disinfection system, is shown as Figure 13.6.

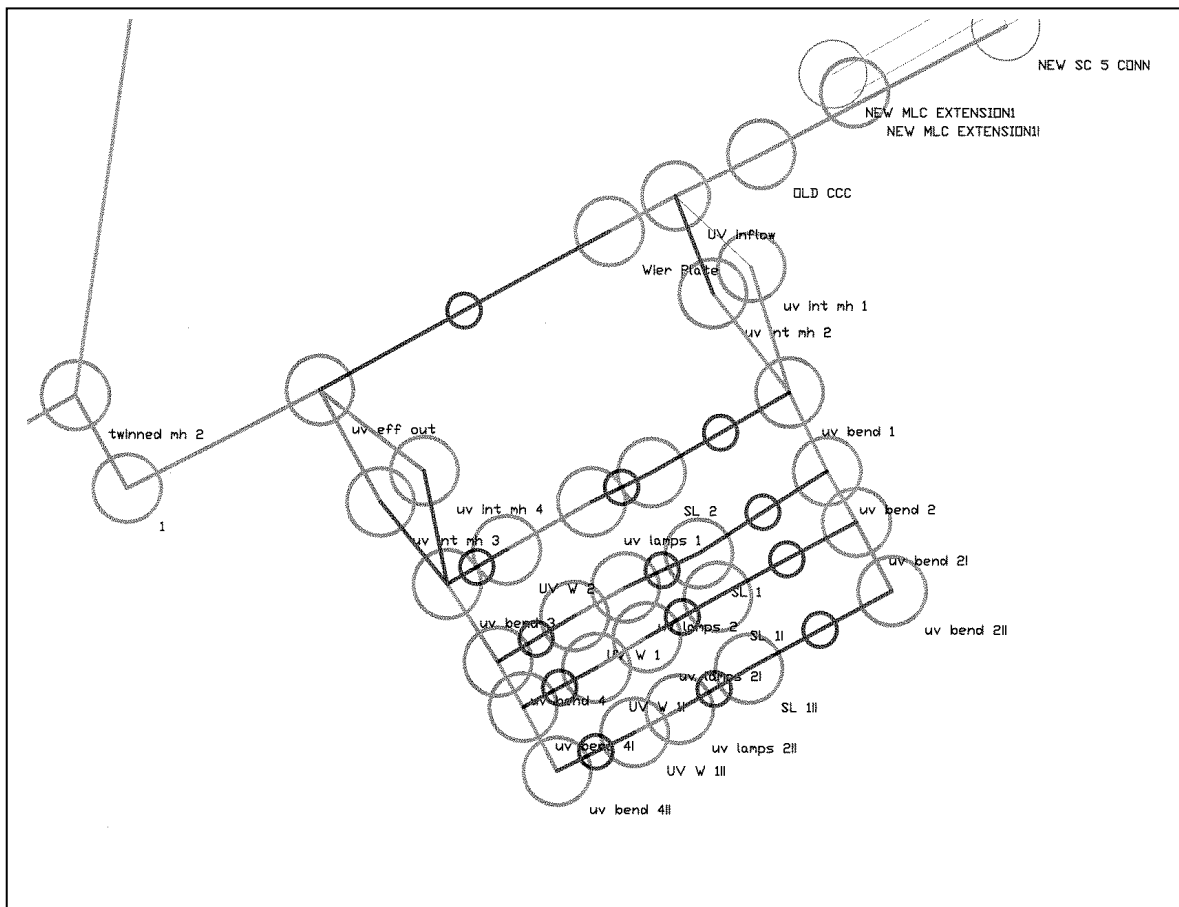

Figure 13.6: Model Input- Nodes and Links – UV Disinfection

The UV disinfection structure as expanded will include four UV lamp channels and a UV bypass channel, with routing gates throughout. As indicated on this figure, nodes are assigned at the channel intersection points and at points to allow the entry of gates and UV lamp assemblies.

13.7 HYDRAULIC SCENARIOS MODELED

The hydraulic modeling to date has analyzed key influent flowrates ranging from 20 ML/d to 422 ML/d. The low value (20 ML/d) was considered to review hourly low flow conditions, for the purpose of evaluating low flow velocities in critical conduit segments. The high value (422 ML/d) was considered to evaluate projected maximum sewer input plus plant recycle flows. As indicated in Section 7 - Raw Sewage Pumping and Headworks, the design criteria for the raw sewage pumping are to provide for a total installed pumping capacity of at least 415 ML/d and a firm pumping capacity of 300 ML/d. The existing influent pumping system includes two pumps with capacity of 114 ML/d each and two pumps rated with capacity of 80 ML/d each. This provides a current installed capacity of 388 ML/d and a firm rated capacity of 274 ML/d. The current Conceptual Design includes planning to replace one of the smaller pumps with a new pump of higher capacity (at least 114 ML/d). Thus, the expanded and upgraded plant influent

pumping system will have an installed capacity of at least 422 ML/d and a firm rated capacity of at least 308 ML/d.

To date, Stantec has modeled the SEWPCC in the planned upgraded and expanded condition using InfoWorks®, for the following influent sewer flowrates:

- 55 ML/d influent (Winter Minimum Day).
- 200 ML/d influent.
- 300 ML/d influent.
- 300 ML/d influent, with high Red River water elevation.
- 422 ML/d influent, with high Red River water elevation.
- 20 ML/d influent.

13.8 MODELING RESULTS

13.8.1 Outputs of the Hydraulic Model

Each model simulation reflects a specific set of input flowrate and routing gate positions and other input control conditions. Outputs of the InfoWorks® hydraulic model for each simulation include the following:

- A plan view display of the Nodes and Links diagram. This includes a colored track with arrows highlighting the pathway selected for display of profiles by the user for specific pathways of interest.
- The flowrate that developed in each link (conduit) segment of the model. Among other things, this displays how the flow gets split and distributed among multiple parallel pathways; for example, how the primary effluent flow gets distributed to each of the four parallel BNR bioreactor trains.
- Concentric warning rings on the plan Nodes and Links diagram, showing where any overflowing occurs for that flow scenario. (None appeared for the SEWPCC simulations).
- Vertical section Hydraulic Profile display along a pathway selected by the user.
- Tables of data for all Nodes and Conduits related to water surface, hydraulic grade elevation, flow velocity, hydraulic gradient (head loss over length or through item), and other features.

Only one pathway at a time is highlighted (**in red**) for profiling in the model output, although many pathways may be flowing simultaneously (e.g. parallel flow through three clarifiers). The software allows for a wide variety of output information displays.

Stantec reviewed each set of model simulation results to perform spot checks of flowrate distribution and balance and reasonableness of hydraulic profile reflecting head losses through portions of the treatment plant based on experience. Additional model refinement, simulations, and further checking will be performed during the Detailed Design phase of the project.

13.8.2 Example Model Simulation Result

As an example of the model outputs, a set of InfoWorks® results for a selected simulation is provided below. This example is for the simulation of 300 ML/d (3.47 m³/s) of raw wastewater influent to the SEWPCC. This value represents the Maximum Day (summertime) influent flowrate. This simulation also incorporated an input for Red River water elevation of +229.0 m, which represents an extreme river flood level.

Figure 13.7 shows the model output plan of the Nodes and Links diagram for 300 ML/d influent flowrate. This includes a track highlighted on the pathway selected for display of the vertical hydraulic profile. Figure 13.7 only shows the treatment plant portion of the model. The pathway selected for profile display includes the influent pump discharge compartment, one of the existing grit chambers, one of the three PSTs (PST Number 1), one of the four BNR bioreactor trains (the northernmost train), one of the five secondary clarifiers (Secondary Clarifier Number 1), and one of the four UV disinfection lamp channels (the northernmost of the four lamp channels). Although the pathway highlighting only tracks one of the parallel trains or units, the model was simulating flow distributed among all of the parallel treatment units; as well as a portion of the influent flow diverted through the vortex grit chambers, fine screens, and the Plant bypass line.

Figure 13.8 shows a plan view of the outfall pipeline portion of the model. This simply indicates that the outfall pipeline and its associated hydraulic features, along with the Red River high water elevation, were included in this model simulation for 300 ML/d of influent flow.

The vertical hydraulic profile through the treatment plant for the 300 ML/d influent flowrate simulation is shown on Figure 13.9. This corresponds to the selected display pathway shown on Figure 13.7. The corresponding vertical hydraulic profile through the outfall pipeline for the 300 ML/d influent flowrate simulation is shown on Figure 13.10.

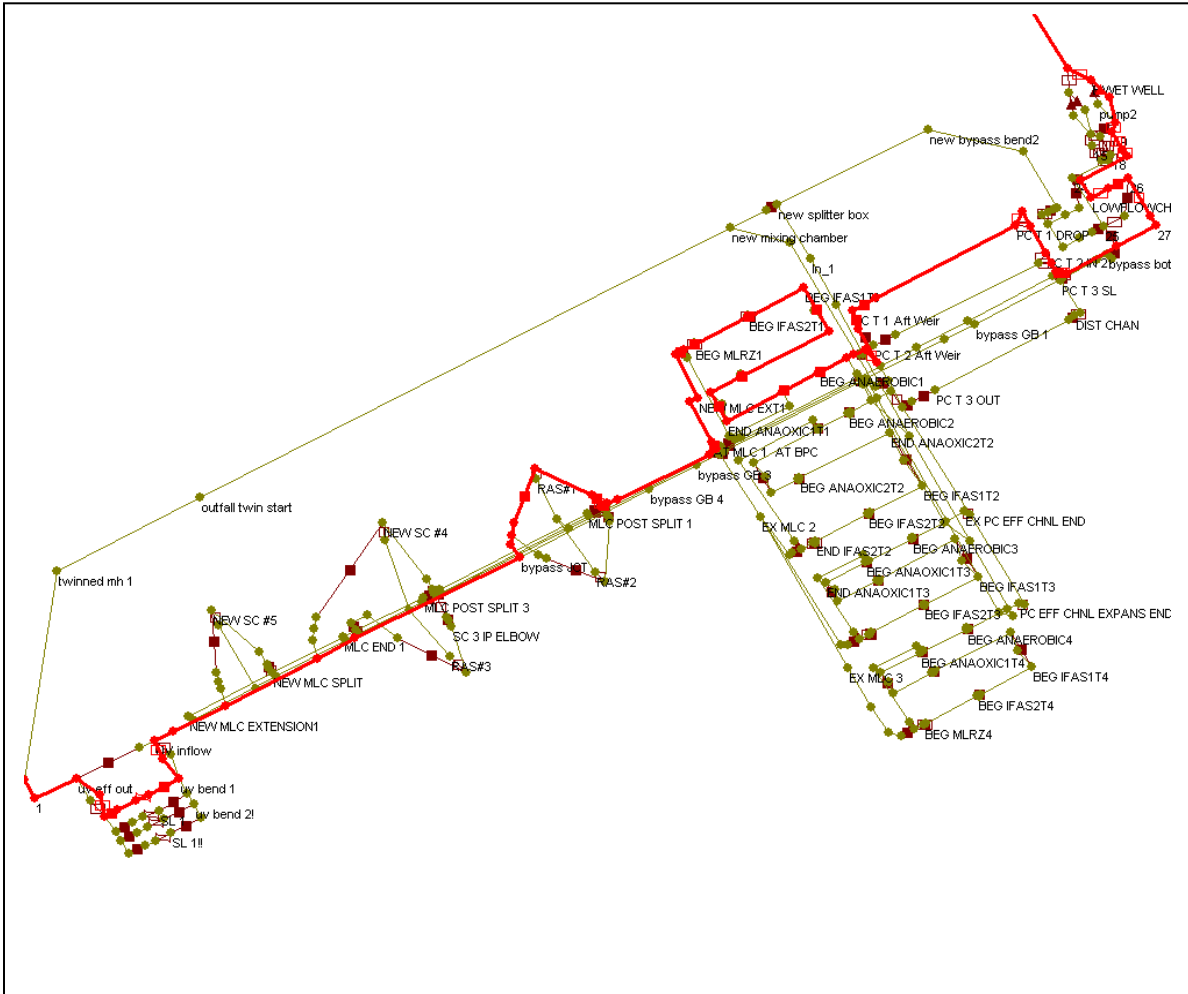

Figure 13.7: Model Output Plan – 300 ML/d, High River - Plant

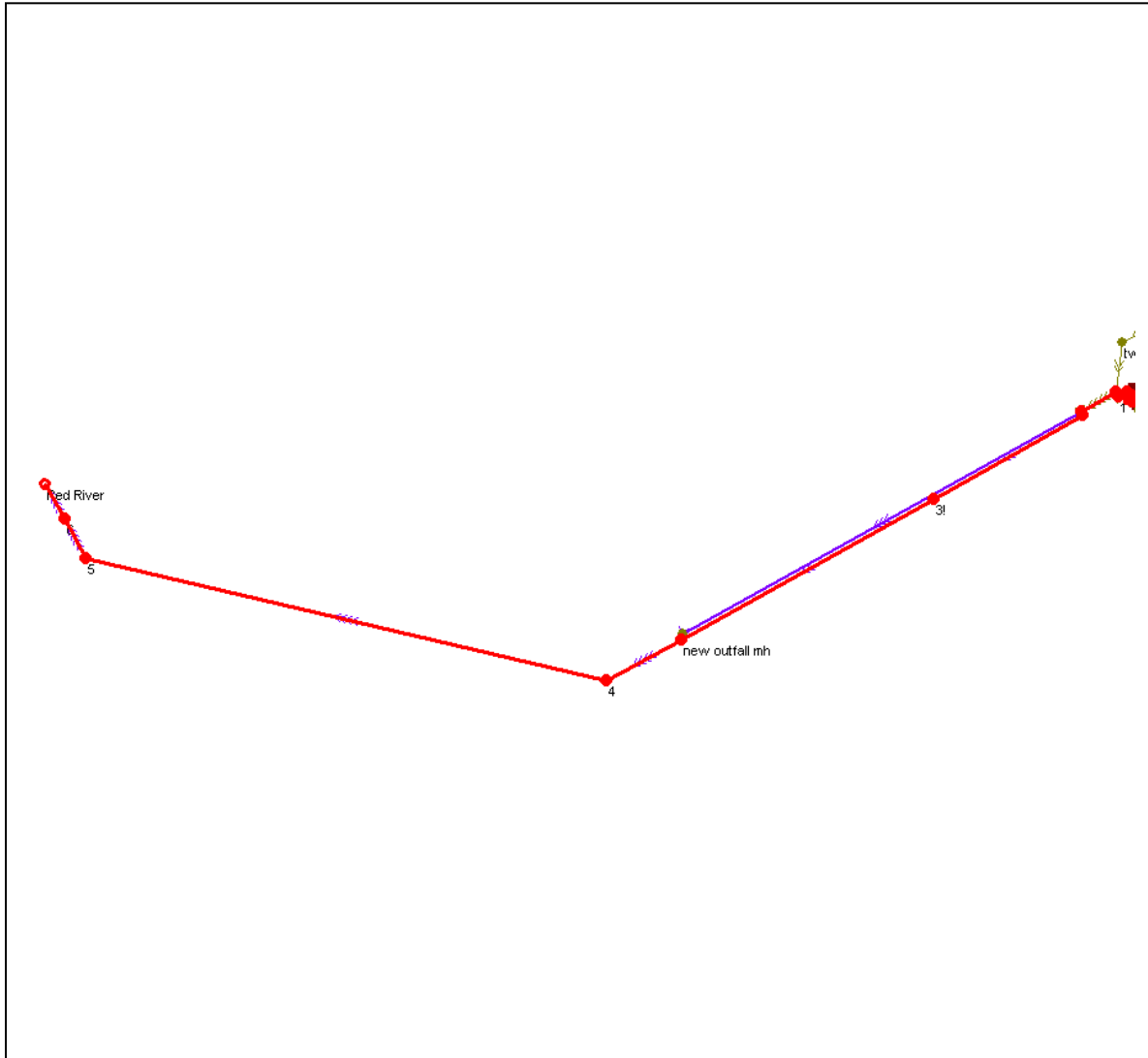

Figure 13.8: Model Output Plan – Outfall - 300 MLD with High River Level

Selected tabular output data from the InfoWorks® model simulation for 300 ML/d influent flowrate and high Red River water elevation are provided below. The tables include formatted versions of output data sets exported from the InfoWorks® model. The formatting included editing to hide output data columns that are inapplicable, such as InfoWorks® default output data columns related to sewer systems, which do not apply to this plant model. InfoWorks® default heading formats for the data columns were re-formatted for easier reading.

The InfoWorks® outputs include separate tables of data for nodes, conduits (links), weirs, gates, orifices, screens, and pumps. The conduits tables provide the resulting flowrates in each of the conduit segments. Each conduit segment is connected to a Node at the upper and lower end of the conduit. The nodes output data tables provide the resulting liquid surface elevation and the

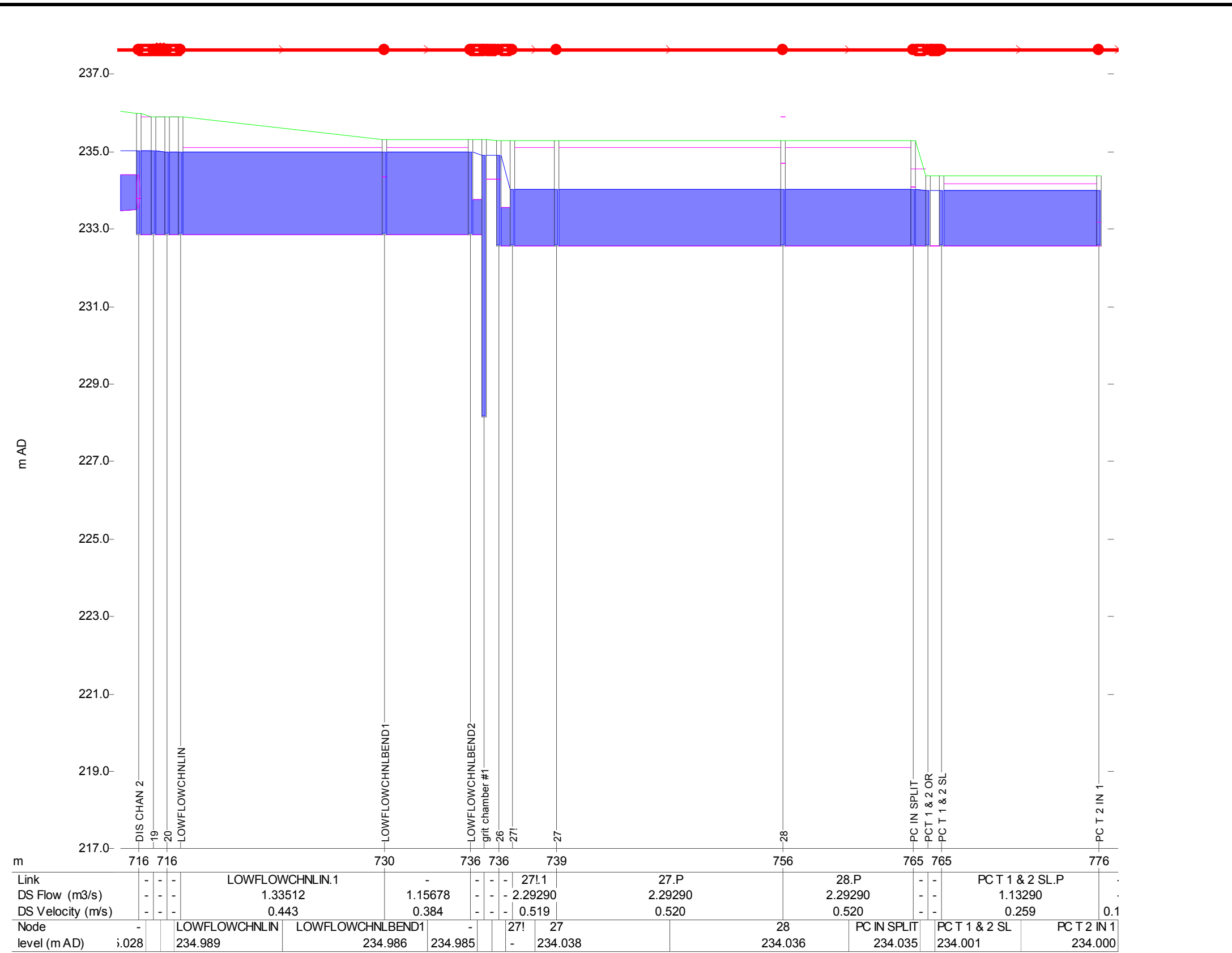

Figure 13.9: Part A - Headworks to Primary Clarifier

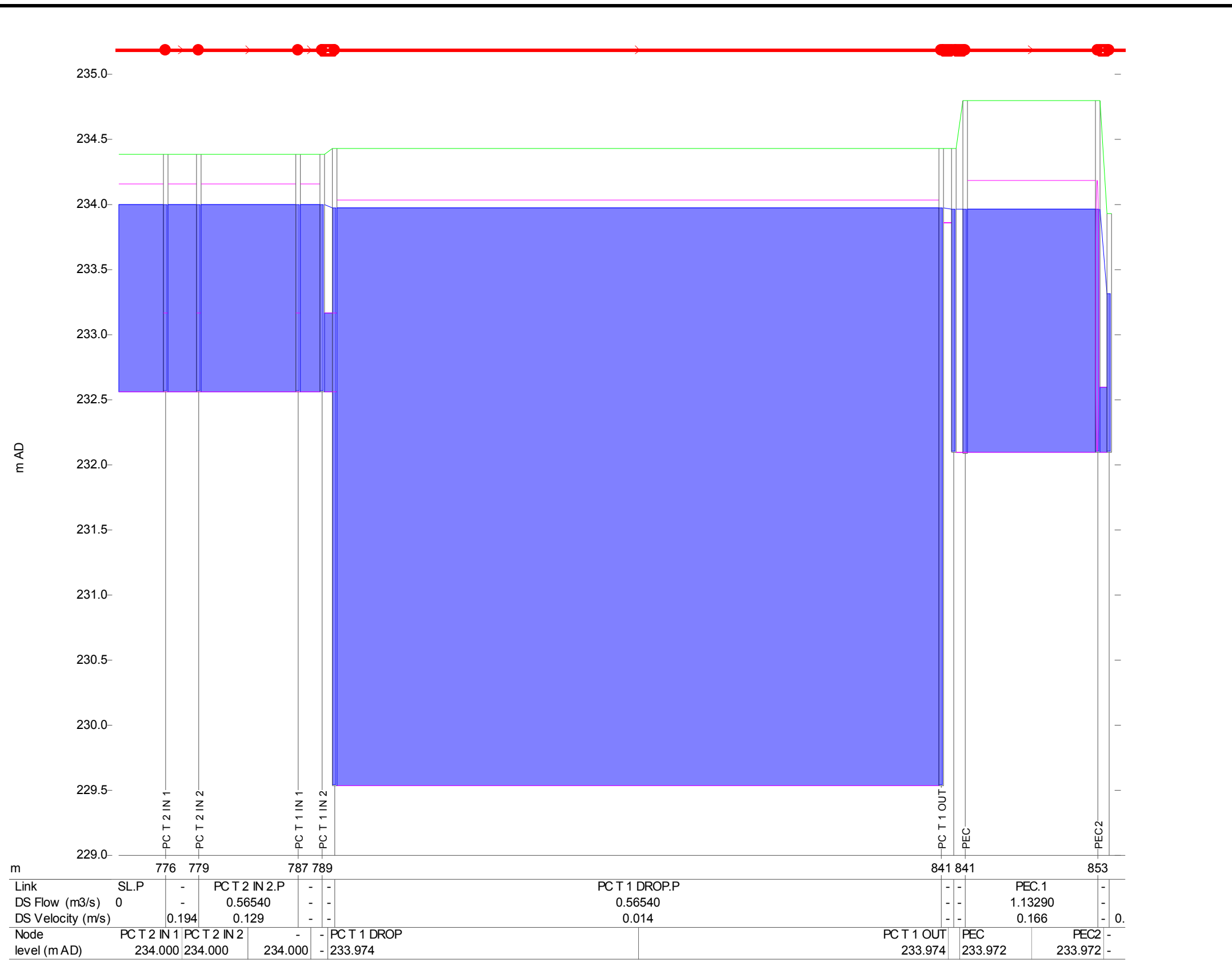

Figure 13.9: Part B - Primary Clarifier to Bioreactor

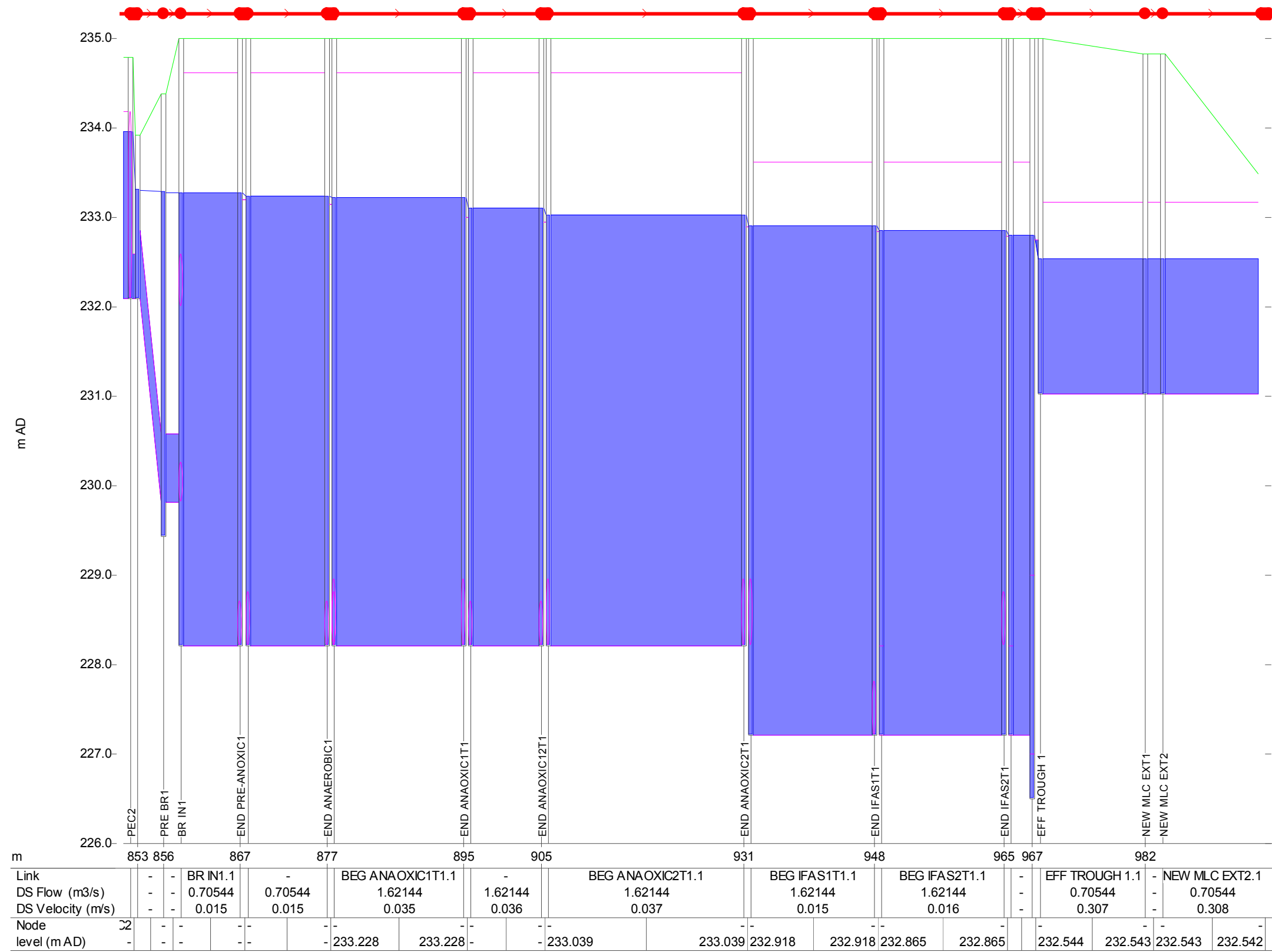

Figure 13.9: Part C - Bioreactors to Secondary Clarifiers

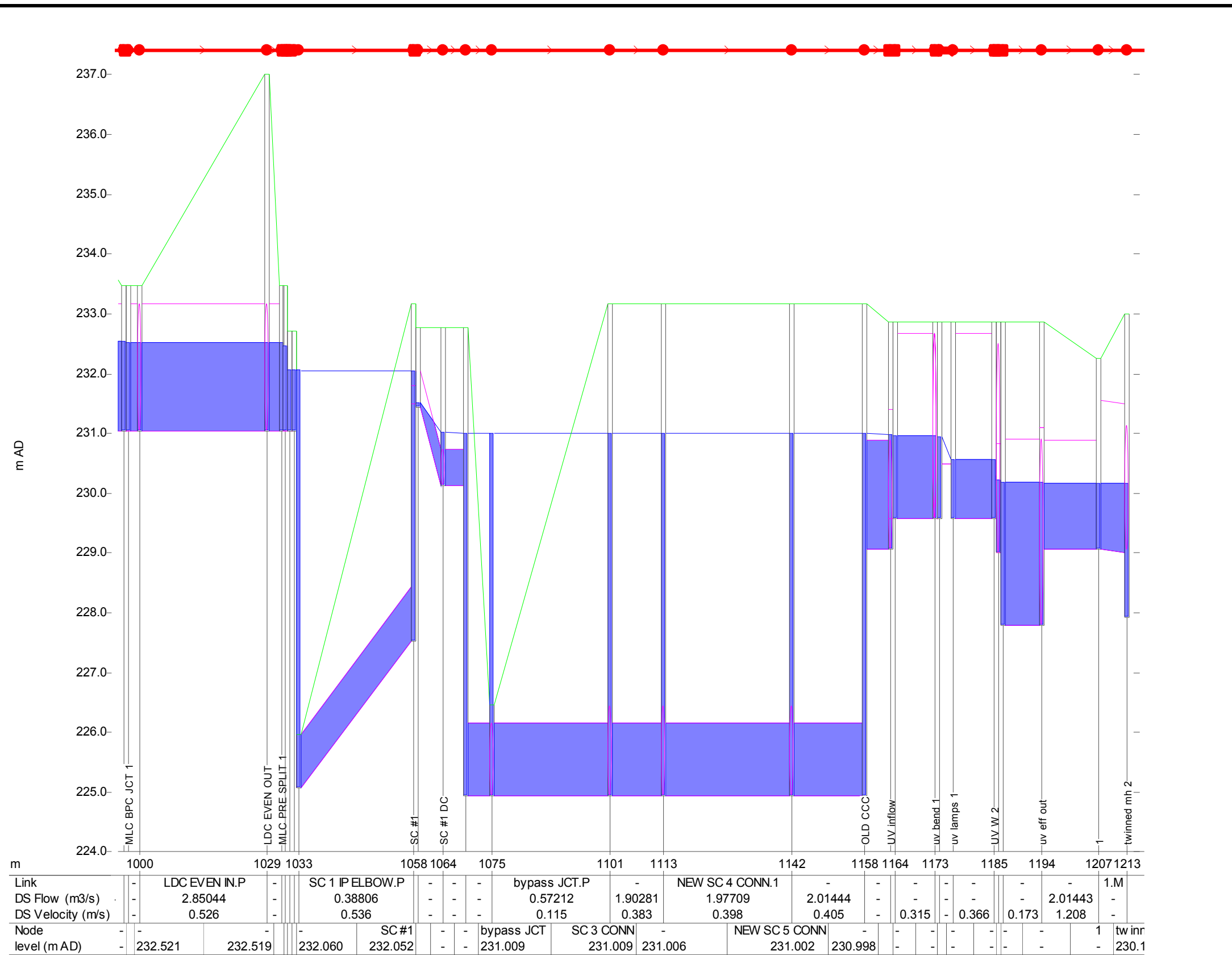

Figure 13.9: Part D - Secondary Clarifiers to UV Disinfection

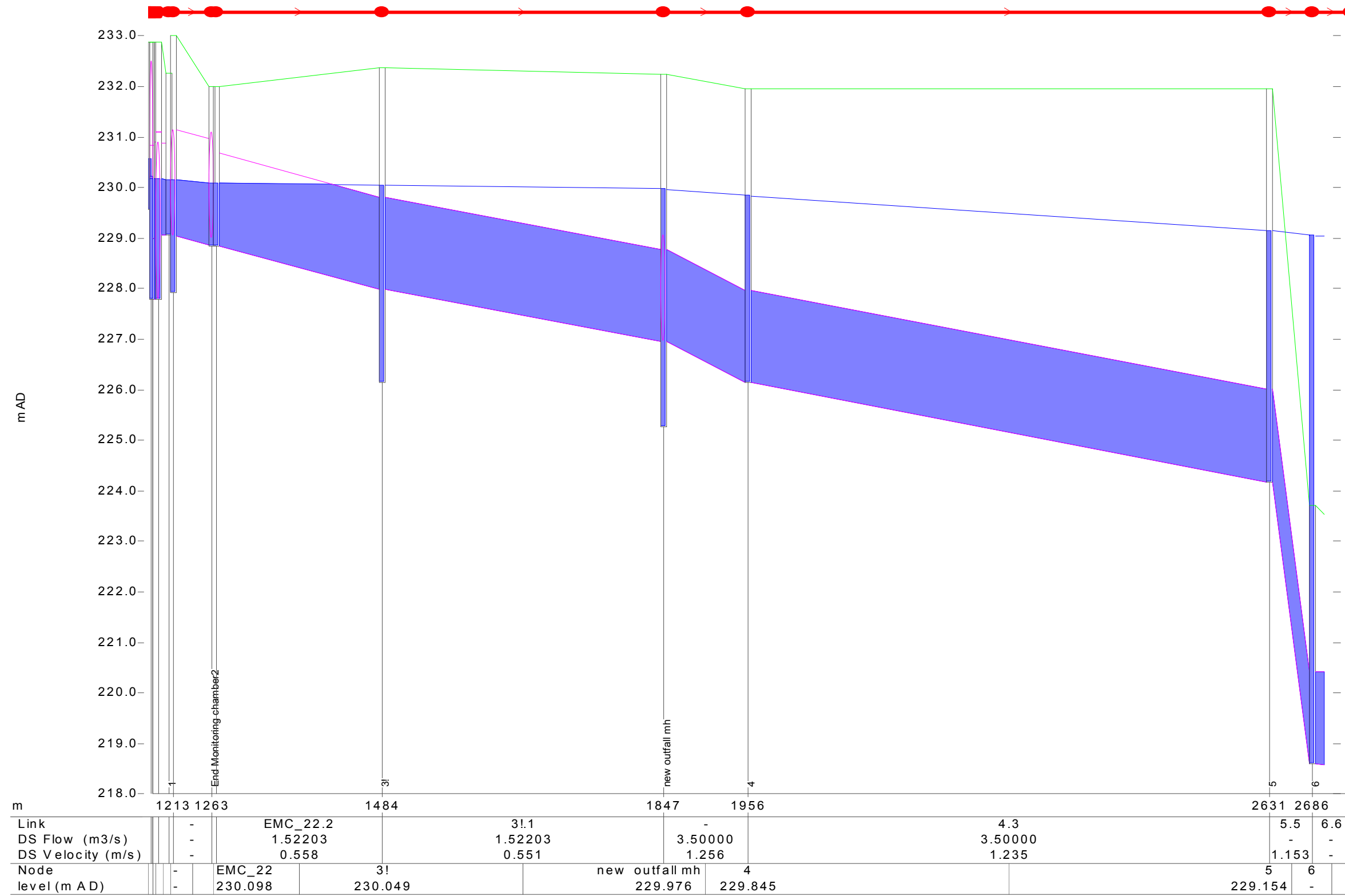

Figure 13.10: Hydraulic Profile Outfall Pipeline - 300 ML/d and High River Level

resulting total hydraulic grade elevation at each node. They indicate whether closed conduits such as pipes are flowing full; and, if so, an indication of the degree of pressurization of the conduit. These data sets also indicate whether the liquid has reached the elevation of overflow at any point in the system (such as a channel rim), or whether the liquid has come within a specific sidewater depth safety factor entered for each node. These two data sets provide the most important initial information for review. If overflow occurs for the plant flowrate entered, these output data sets also display the location and magnitude of the overflow. Additional information is provided on these two output tables and on the other output tables, related to head loss through specific items such as screens, unit hydraulic gradient values, and flow velocities, and other information.

Additional model data output tables are provided in the Appendix K, including simulations for the other influent flowrate input values ranging from 20 ML/d to 415 ML/d.

13.9 CONCLUSION

The model output data for the simulation of 300 ML/d influent flowrate with high Red River water elevation of +229.0 m indicates that a portion of the outfall pipeline system is surcharged. However, based on the proposed design surcharge conditions would not extend back into the treatment units to the point where treatment structures would overflow or be significantly impaired. Under the conditions modeled, the resulting water level in the effluent launders of the secondary clarifiers is projected to be +231.519 m. That is 0.523 m below the crest of the clarifier weir, which is at elevation +232.052. This indicates that the secondary clarifier weirs would not be surcharged, and in fact that sufficient fall would exist to maintain an aerated nappe over the weir. This reflects an improvement in the outfall pipeline hydraulics from the recent historical condition by the addition of the proposed new parallel twinning section of the outfall pipeline. The model indicates that the hydraulic bottleneck effect in the existing single pipe Outfall line will be substantially relieved by the construction of the new twinning outfall pipeline segment.

The liquid head over the weir (the height of the clarifier body liquid over the weir elevation) is projected to be 0.010 m (1.0 cm).

Conclusions from the Conceptual Design evaluations performed to date of the SEWPCC hydraulics include the following:

- The SEWPCC reflected in the current Conceptual Design will be able to handle the projected design flow loadings, when the proposed new plant bypass line is included.
- Even at high plant flowrate (300 ML/d) and Red River elevation of 229 m, the upgraded plant will not surcharge any units.
- The plant design, with the bypass and partial outfall twinning, will handle 422 ML/d without overflowing treatment units.

The following additional steps are anticipated related to the hydraulics of the SEWPCC for the upgrade / expansion project:

- All hydraulic model results for all key loading scenarios will be included in the Conceptual Design Report.
- Some additional detailed field measurement of existing plant features is anticipated during the Detailed Design phase.
- Additional modeling will be performed in conjunction with the design refinement during the Detailed Design phase.
- More detailed modeling of the hydraulics will be performed as the details of the flow splitting and junction structures related to the Plant bypass are refined during the Detailed Design phase.
- The algorithms for flow splitting, diversion and distribution which are reflected in the hydraulic model will also be made available as part of a set of operational tools to allow accurate control of the treatment processes.
- Additional hydraulic modeling of the Influent Pump Station is anticipated, to focus on variable flowrate sewer flows entering the wet well, examining time increments on the order of 1 minute.
- The plant hydraulic model will be available in the future for integration with hydraulic modeling of the sewer system.

The SEWPCC upgrade / expansion construction will require the existing treatment plant continue in service while it is being modified and expanded. This will require careful planning for construction sequencing. In conjunction with this planning, it is proposed that additional modeling of hydraulic conditions be performed to simulate interim plant conditions during the construction phase. It is recommended that those efforts focus, among other things, on the BNR bioreactor section of the plant, where the existing High Purity Oxygen (HPO) treatment units will be successively converted to be new BNR treatment sections and where additional new compartments for BNR will also be added. That process will likely require that at least one of the existing HPO treatment trains will be taken out of service at a time as part of the conversion process. The hydraulic modeling of the construction-period conditions should be done after the plans for interim treatment operations are finalized as part of the Detailed Design phase.

Table 13.1 - 300 ML/d Model Output Data - Nodes

Node ID	Level (m AD)	Flood Depth (m)	Flood Volume (m3)	Volume Lost (m3)	Max Level (m AD)	Max Flood Depth (m)	Max Flood Volume (m3)	Max Volume Lost (m3)	Max Volume (m3)	Volume balance (%)
x1	220.319	-9.781	-57.7	0	220.319	-9.781	-57.7	0	0.6	0
UV W 2	230.566	-2.104	-2.1	0	230.566	-2.104	-2.1	0	1	0
uv lamps 1	230.567	-2.103	-2.1	0	230.567	-2.103	-2.1	0	1	0
uv int mh 4	230.179	-2.491	-2.5	0	230.179	-2.491	-2.5	0	2.4	0
uv int mh 2	230.966	-1.704	-1.7	0	230.966	-1.704	-1.7	0	1.4	0
UV inflow	230.993	-1.877	-4.2	0	230.993	-1.877	-4.2	0	10.3	0
uv eff out	230.178	-2.492	-142	0	230.178	-2.492	-142	0	135.6	0
uv bend 3	230.216	-2.454	-2.5	0	230.216	-2.454	-2.5	0	1.2	0
uv bend 1	230.965	-1.705	-1.7	0	230.965	-1.705	-1.7	0	1.4	0
twinned mh 2	230.163	-2.837	-7.4	0	230.163	-2.837	-7.4	0	5.8	0
SL 2	230.956	-1.714	-1.7	0	230.956	-1.714	-1.7	0	1.4	0
SC 3 CONN	231.009	-2.163	-39.4	0	231.009	-2.163	-39.4	0	110.4	0
SC 1&2 EDB	231.009	-1.757	-2.6	0	231.009	-1.757	-2.6	0	9.1	0
SC 1 OR	232.076	-0.436	-0.4	0	232.076	-0.436	-0.4	0	1	0
SC 1 IPC	232.068	-0.444	-1	0	232.068	-0.444	-1	0	2.4	0
SC 1 IP ELBOW	232.06	6.091	0	0	232.06	6.091	0	0	0.9	0
SC #1 LAUNDER	231.519	-1.247	-79.8	0	231.519	-1.247	-79.8	0	5.5	0
SC #1 DC	231.021	-1.745	-3.5	0	231.021	-1.745	-3.5	0	1.8	0
SC #1	232.052	-1.12	-988.8	0	232.052	-1.12	-988.8	0	3989.9	0
Red River	229				229					
pump1	235.028	-0.972	-1	0	235.028	-0.972	-1	0	18	0
PRE BR1	233.292	-1.099	-2	0	233.292	-1.099	-2	0	6.4	0
PEC2	233.972	-0.778	-0.8	0	233.972	-0.778	-0.8	0	1.9	0
PEC	233.972	-0.778	-3.9	0	233.972	-0.778	-3.9	0	9.4	0
PCT 1 & 2 OR	234.011	-0.152	-0.2	0	234.011	-0.152	-0.2	0	1.4	0
PC T 2 IN 2	234	-0.163	-0.2	0	234	-0.163	-0.2	0	1.4	0
PC T 2 IN 1	234	-0.163	-0.2	0	234	-0.163	-0.2	0	1.4	0
PC T 1 OUT	233.974	-0.181	-0.2	0	233.974	-0.181	-0.2	0	4.4	0
PC T 1 IN 2	234	-0.163	-0.2	0	234	-0.163	-0.2	0	1.4	0
PC T 1 IN 1	234	-0.163	-0.2	0	234	-0.163	-0.2	0	1.4	0
PC T 1 DROP	233.974	-0.181	-0.2	0	233.974	-0.181	-0.2	0	4.4	0
PC T 1 Aft Weir	233.973	-0.182	-0.2	0	233.973	-0.182	-0.2	0	1.9	0
PC T 1 & 2 SL	234.001	-0.162	-0.2	0	234.001	-0.162	-0.2	0	1.4	0

Table 13.1 - 300 ML/d Model Output Data - Nodes

Node ID	Level (m AD)	Flood Depth (m)	Flood Volume (m3)	Volume Lost (m3)	Max Level (m AD)	Max Flood Depth (m)	Max Flood Volume (m3)	Max Volume Lost (m3)	Max Volume (m3)	Volume balance (%)
PC IN SPLIT	234.035	-1.067	-1.1	0	234.035	-1.067	-1.1	0	1.5	0
OLD CCC	230.998	-1.562	-37.1	0	230.998	-1.562	-37.1	0	144.1	0
NEW SC 5 CONN	231.002	-2.17	-39.5	0	231.002	-2.17	-39.5	0	110.3	0
NEW SC 4 CONN	231.006	-2.166	-39.4	0	231.006	-2.166	-39.4	0	110.4	0
new outfall mh	229.976	-2.274	-2.3	0	229.976	-2.274	-2.3	0	13.5	0
NEW MLC EXT2	232.543	-2.077	-2.1	0	232.543	-2.077	-2.1	0	1.5	0
NEW MLC EXT1	232.543	-2.077	-2.1	0	232.543	-2.077	-2.1	0	1.5	0
MLC SPLIT 1	232.474	-0.698	-0.7	0	232.474	-0.698	-0.7	0	1.4	0
MLC PRE SPLIT 1	232.518	-0.654	-0.7	0	232.518	-0.654	-0.7	0	1.5	0
MLC BPC JCT 1	232.521	-0.65	-0.6	0	232.521	-0.65	-0.6	0	1.5	0
MID ANAOXIC12T1	233.107	-1.543	-1.5	0	233.107	-1.543	-1.5	0	4.9	0
LOWFLOWCHNLIN	234.989	-0.926	-3.5	0	234.989	-0.926	-3.5	0	8	0
LOWFLOWCHNLBEND2	234.985	-0.117	-0.1	0	234.985	-0.117	-0.1	0	2.1	0
LOWFLOWCHNLBEND1	234.986	-0.116	-0.1	0	234.986	-0.116	-0.1	0	2.1	0
LDC EVEN OUT	232.519	-4.481	-4.5	0	232.519	-4.481	-4.5	0	1.5	0
LDC EVEN IN	232.521	-0.651	-0.7	0	232.521	-0.651	-0.7	0	1.5	0
INLET STRUC	219.61	-10.51	-103	0	219.61	-10.51	-103	0	0	0
grit chamber #1	234.915	-0.39	-32.6	0	234.915	-0.39	-32.6	0	564	0
EX PC EFF CHNL IN	233.32	-0.614	-1.6	0	233.32	-0.614	-1.6	0	3.2	0
END PRE-ANOXIC1	233.279	-1.371	-1.4	0	233.279	-1.371	-1.4	0	5.1	0
End Monitoring chamber#2	230.099	-1.901	-12.2	0	230.099	-1.901	-12.2	0	8	0
END MLRZ1	232.809	-1.841	-1.8	0	232.809	-1.841	-1.8	0	6.3	0
END IFAS2T1	232.865	-1.785	-1.8	0	232.865	-1.785	-1.8	0	5.6	0
END IFAS1T1	232.918	-1.732	-1.7	0	232.918	-1.732	-1.7	0	5.7	0
END ANAOXIC2T1	233.039	-1.611	-1.6	0	233.039	-1.611	-1.6	0	4.8	0
END ANAOXIC1T1	233.228	-1.422	-1.4	0	233.228	-1.422	-1.4	0	5	0
END ANAOXIC12T1	233.107	-1.543	-1.5	0	233.107	-1.543	-1.5	0	4.9	0
END ANAEROBIC1	233.25	-1.4	-1.4	0	233.25	-1.4	-1.4	0	5	0
EMC_22	230.098	-1.902	-11.4	0	230.098	-1.902	-11.4	0	7.5	0
EFF TROUGH 1	232.544	-2.106	-2.1	0	232.544	-2.106	-2.1	0	1.5	0
E WET WELL	217	-9	-394.2	0	217	-9	-394.2	0	41.6	0
DIS CHAN 2	235.028	-0.952	-21	0	235.028	-0.952	-21	0	47.7	0
bypass JCT	231.009	4.847	0.3	0	231.009	4.847	0.3	0	2.2	0

Table 13.1 - 300 ML/d Model Output Data - Nodes

Node ID	Level (m AD)	Flood Depth (m)	Flood Volume (m3)	Volume Lost (m3)	Max Level (m AD)	Max Flood Depth (m)	Max Flood Volume (m3)	Max Volume Lost (m3)	Max Volume (m3)	Volume balance (%)
BR IN1	233.279	-1.371	-1.4	0	233.279	-1.371	-1.4	0	5.1	0
BEG MLRZ1	232.809	-1.841	-1.8	0	232.809	-1.841	-1.8	0	5.6	0
BEG IFAS2T1	232.865	-1.785	-1.8	0	232.865	-1.785	-1.8	0	5.6	0
BEG IFAS1T1	232.918	-1.732	-1.7	0	232.918	-1.732	-1.7	0	5.7	0
BEG ANAOXIC2T1	233.039	-1.611	-1.6	0	233.039	-1.611	-1.6	0	4.8	0
BEG ANAOXIC1T1	233.228	-1.422	-1.4	0	233.228	-1.422	-1.4	0	5	0
BEG ANAEROBIC1	233.25	-1.4	-1.4	0	233.25	-1.4	-1.4	0	5	0
AT MLC 1 AT BPC	232.542	-0.629	-0.6	0	232.542	-0.629	-0.6	0	1.5	0
6	229.062	5.342	0	0	229.062	5.342	0	0	5.1	0
5	229.154	-2.796	-3.1	0	229.154	-2.796	-3.1	0	12.4	0
4	229.845	-2.105	-19.6	0	229.845	-2.105	-19.6	0	34.5	0
3!	230.049	-2.331	-2.6	0	230.049	-2.331	-2.6	0	10.8	0
28	234.036	-1.066	-1.1	0	234.036	-1.066	-1.1	0	1.5	0
27!	234.038	-1.064	-1.1	0	234.038	-1.064	-1.1	0	1.5	0
27	234.038	-1.064	-1.1	0	234.038	-1.064	-1.1	0	1.5	0
26	234.907	-0.195	-0.2	0	234.907	-0.195	-0.2	0	2.3	0
20	235.001	-0.914	-0.9	0	235.001	-0.914	-0.9	0	2.1	0
19	235.016	-0.901	-4.7	0	235.016	-0.901	-4.7	0	11.2	0
1	230.166	-2.094	-54.4	0	230.166	-2.094	-54.4	0	28.8	0

Table 13.2 - 300 ML/d Model Output Data - Conduit

US Node ID	Link Suffix	DS Depth (m)	DS Flow (m3/s)	DS Froude number	DS Velocity (m/s)	Hydraulic Gradient	Max DS Depth (m)	Max DS Flow (m3/s)	Max DS Froude number	Max DS Velocity (m/s)	Max Surcharge State	Max US Depth (m)	Surcharge State	US Depth (m)	US Flow (m3/s)	US Froude number	US Velocity (m/s)	Volume (m3)
x1	1	0.099	0	0	0	0.00086	0.099	0	0	0	0.05	0.099	0.05	0.099	0	0	0	39.2
uv lamps 1	P	0.996	0.51813	0.117	0.366	9.00E-05	0.996	0.51813	0.117	0.366	0.32	0.997	0.32	0.997	0.51813	0.117	0.366	13
uv int mh 4	P	2.378	1.00722	0.036	0.173	0.00001	2.378	1.00722	0.036	0.173	0.77	2.378	0.77	2.378	1.00722	0.036	0.173	49.5
uv int mh 2	P	1.395	1.00643	0.085	0.315	4.00E-05	1.395	1.00643	0.085	0.315	0.45	1.396	0.45	1.396	1.00643	0.085	0.315	29.1
uv eff out	P	1.109	2.01444	0.399	1.208	0.0008	1.109	2.01444	0.399	1.208	0.61	1.12	0.61	1.12	2.01444	0.392	1.195	21.5
twinned mh 2	1	1.23	3.5	0.526	1.661	0.00125	1.23	3.5	0.526	1.661	0.59	1.122	0.59	1.122	3.5	0.626	1.859	99.2
SC 3 CONN	1	6.064	1.90281	0.015	0.383	1.00E-04	6.064	1.90281	0.015	0.383	2	6.065	2	6.065	1.90281	0.015	0.383	59.4
SC 1&2 EDB	P	6.067	0.57212	0.004	0.115	0.00001	6.067	0.57212	0.004	0.115	2	6.067	2	6.067	0.57212	0.004	0.115	29.3
SC 1 IPC	P	6.991	0.38806	0.025	0.505	0.00511	6.991	0.38806	0.025	0.505	1	1.027	1	1.027	0.38806	0.032	0.587	0.7
SC 1 IP ELBOW	P	4.519	0.38806	0.027	0.536	2.30E-04	4.519	0.38806	0.027	0.536	1	6.989	1	6.989	0.38806	0.025	0.505	19.1
SC #1 LAUNDER	P	0.897	0.28306	0.021	0.364	0.08885	0.897	0.28306	0.021	0.364	1	0.086	1	0.086	0.28306	2.914	2.684	2.2
SC #1 DC	P	0.886	0.57212	0.042	0.736	8.40E-04	0.886	0.57212	0.042	0.736	2	0.89	2	0.89	0.57212	0.042	0.736	3.9
pump1	1	1.528	0	0	0	-1.00E-05	1.528	0	0	0	1	1.628	1	1.628	0	0	0	5.3
PRE BR1	1	3.461	0.49644	0.053	0.968	0.00212	3.461	0.49644	0.053	0.968	2	3.466	2	3.466	0.49644	0.053	0.967	1.3
PEC	1	1.867	1.1329	0.039	0.166	0.00001	1.867	1.1329	0.039	0.166	0.9	1.867	0.9	1.867	1.1329	0.039	0.166	77.1
PC T 2 IN 2	P	1.435	0.5654	0.034	0.129	0.00001	1.435	0.5654	0.034	0.129	0.9	1.435	0.9	1.435	0.5654	0.034	0.129	37.2
PC T 2 IN 1	P	1.435	0.84862	0.052	0.194	0.00001	1.435	0.84862	0.052	0.194	0.9	1.435	0.9	1.435	0.84862	0.052	0.194	12.3
PC T 1 IN 1	P	1.435	0.28267	0.017	0.065	0	1.435	0.28267	0.017	0.065	0.9	1.435	0.9	1.435	0.28267	0.017	0.065	9.2
PC T 1 DROP	P	4.434	0.5654	0.002	0.014	0	4.434	0.5654	0.002	0.014	0.99	4.434	0.99	4.434	0.5654	0.002	0.014	2087.5
PC T 1 & 2 SL	P	1.435	1.1329	0.069	0.259	2.00E-05	1.435	1.1329	0.069	0.259	0.9	1.938	0.9	1.938	1.1329	0.069	0.259	49
OLD CCC	1	1.936	2.01444	0.086	0.746	2.80E-04	1.936	2.01444	0.086	0.746	2	1.938	2	1.938	2.01444	0.086	0.746	15.3
NEW SC 5 CONN	1	6.056	2.01444	0.016	0.405	1.10E-04	6.056	2.01444	0.016	0.405	2	6.058	2	6.058	2.01444	0.016	0.405	81.1
NEW SC 4 CONN	1	6.06	1.97709	0.015	0.398	1.10E-04	6.06	1.97709	0.015	0.398	2	6.063	2	6.063	1.97709	0.015	0.398	143.4
new outfall mh	1	3.707	3.5	0.046	1.256	0.00101	3.707	3.5	0.046	1.256	1	2.997	1	2.997	3.5	0.047	1.267	301.6
NEW MLC EXT2	1	1.504	0.70544	0.08	0.308	5.00E-05	1.504	0.70544	0.08	0.308	0.7	1.505	0.7	1.505	0.70544	0.08	0.308	30.7
NEW MLC EXT1	1	1.505	0.70544	0.08	0.308	5.00E-05	1.505	0.70544	0.08	0.308	0.7	1.505	0.7	1.505	0.70544	0.08	0.308	5.6
MLC BPC JCT 1	P	1.483	0.81226	0.079	0.299	3.00E-05	1.483	0.81226	0.079	0.299	0.69	1.483	0.69	1.483	0.81226	0.079	0.299	6.7
MID ANAOXIC12T1	1	4.888	1.62144	0.005	0.036	0	4.888	1.62144	0.005	0.036	0.76	4.888	0.76	4.888	1.62144	0.005	0.036	427.9
LOWFLOWCHNLIN	1	2.119	1.33512	0.094	0.443	9.00E-05	2.119	1.33512	0.094	0.443	0.95	2.121	0.95	2.121	1.33512	0.094	0.442	43.6
LOWFLOWCHNLBEND1	1	2.118	1.15678	0.081	0.384	7.00E-05	2.118	1.15678	0.081	0.384	0.95	2.119	0.95	2.119	1.15678	0.081	0.384	18.5
LDC EVEN OUT	P	1.48	1.50058	0.146	0.554	1.20E-04	1.48	1.50058	0.146	0.554	0.69	1.48	0.69	1.48	1.50058	0.146	0.554	8.6
LDC EVEN IN	P	1.481	2.85044	0.138	0.526	6.00E-05	1.481	2.85044	0.138	0.526	0.69	1.482	0.69	1.482	2.85044	0.138	0.526	154.5
EX PC EFF CHNL IN	2	3.474	0.49644	0.053	0.967	0.00391	3.474	0.49644	0.053	0.967	1	1.202	1	1.202	0.49644	0.059	1.037	1.7
EMC_22	2	2.069	1.52203	0.028	0.558	0.00022	2.069	1.52203	0.028	0.558	1	1.247	1	1.247	1.52203	0.241	0.798	524
EMC_22	1	1.249	-1.52203	0.174	-0.609	-0.00019	1.249	-1.52203	0.174	-0.609	0.5	1.228	0.5	1.228	-1.52203	0.179	-0.62	13.6
EFF TROUGH 1	1	1.505	0.70544	0.08	0.307	5.00E-05	1.505	0.70544	0.08	0.307	0.7	1.506	0.7	1.506	0.70544	0.08	0.307	32.8
bypass JCT	P	6.067	0.57212	0.004	0.115	0.00001	6.067	0.57212	0.004	0.115	2	6.067	2	6.067	0.57212	0.004	0.115	130.8
BR IN1	1	5.06	0.70544	0.002	0.015	0	5.06	0.70544	0.002	0.015	0.79	5.06	0.79	5.06	0.70544	0.002	0.015	372
BEG MLRZ1	1	5.59	1.62144	0.002	0.016	0	5.59	1.62144	0.002	0.016	0.87	5.59	0.87	5.59	1.62144	0.002	0.016	300.6
BEG IFAS2T1	1	5.646	1.62144	0.002	0.016	0	5.646	1.62144	0.002	0.016	0.88	5.646	0.88	5.646	1.62144	0.002	0.016	1734.9
BEG IFAS1T1	1	5.699	1.62144	0.002	0.015	0	5.699	1.62144	0.002	0.015	0.89	5.699	0.89	5.699	1.62144	0.002	0.015	1770.6
BEG ANAOXIC2T1	1	4.82	1.62144	0.005	0.037	0	4.82	1.62144	0.005	0.037	0.75	4.82	0.75	4.82	1.62144	0.005	0.037	1172.7
BEG ANAOXIC1T1	1	5.009	1.62144	0.005	0.035	0	5.009	1.62144	0.005	0.035	0.78	5.009	0.78	5.009	1.62144	0.005	0.035	807.3
BEG ANAEROBIC1	1	5.031	0.70544	0.002	0.015	0	5.031	0.70544	0.002	0.015	0.79	5.031	0.79	5.031	0.70544	0.002	0.015	496.5
6	6	10.461	3.5	0.04	1.153	0.001	10.461	3.5	0.04	1.153	1	10.451	1	10.451	3.5	0.04	1.153	153.7
5	5	10.463	3.5	0.04	1.153	0.00144	10.463	3.5	0.04	1.153	1	4.962	1	4.962	3.5	0.045	1.235	162.4
4	4	4.975	3.5	0.045	1.235	0.001	4.975	3.5	0.045	1.235	1	3.689	1	3.689	3.5	0.046	1.256	1897.6
3!	1	3.017	1.52203	0.02	0.551	0.00019	3.017	1.52203	0.02	0.551	1	2.067	1	2.067	1.52203	0.029	0.558	998.3

Table 13.2 - 300 ML/d Model Output Data - Conduit

US Node ID	Link Suffix	DS Depth (m)	DS Flow (m3/s)	DS Froude number	DS Velocity (m/s)	Hydraulic Gradient	Max DS Depth (m)	Max DS Flow (m3/s)	Max DS Froude number	Max DS Velocity (m/s)	Max Surcharge State	Max US Depth (m)	Surcharge State	US Depth (m)	US Flow (m3/s)	US Froude number	US Velocity (m/s)	Volume (m3)
28	P	1.47	2.2929	0.137	0.52	7.00E-05	1.47	2.2929	0.137	0.52	0.58	1.471	0.58	1.471	2.2929	0.137	0.52	41
27	P	1.471	2.2929	0.137	0.52	7.00E-05	1.471	2.2929	0.137	0.52	0.58	1.472	0.58	1.472	2.2929	0.137	0.519	71.1
27!	1	1.473	2.2929	0.137	0.519	8.00E-05	1.473	2.2929	0.137	0.519	0.58	1.473	0.58	1.473	2.2929	0.137	0.519	13.9
1	M	1.163	2.01444	0.256	0.866	0.0005	1.163	2.01444	0.256	0.866	0.47	1.109	0.47	1.109	2.01444	0.275	0.908	14.2

Table 13.3 - 300 ML/d Model Output Data - Weirs

US Node ID	Link Suffix	DS Depth (m)	DS Flow (m3/s)	DS Froude number	Max DS Depth (m)	Max DS Froude number	Max DS Velocity (m/s)	Max Surcharge State	US Depth (m)	US Froude number	US Cumulative Flow (m3)	US Velocity (m/s)	Volume (m3)
AT MLC 1 AT BPC	W	1.483	0.705	0.102	1.483	0	0.000	2.000	1.504	0.1	30474.88	0.384	0
END ANAEROBIC1	1	0.078	0.35041	0.559	0.078	0	0	2	0.1	0.391	15137.85	0.387	0
END ANAOXIC12T1	1	0.089	0.98857	1.305	0.089	0	0	2	0.157	0.559	42706.13	0.693	0
END ANAOXIC1T1	1	0.107	1.06076	1.941	0.107	0	0	2	0.228	0.62	45824.87	0.928	0
END ANAOXIC2T1	1	0.018	0.64422	17.098	0.018	0	0	2	0.139	0.793	27830.25	0.926	0
END IFAS1T1	1	0.015	0.76946	7.163	0.015	0	0	2	0.068	0.75	33240.79	0.612	0
END IFAS2T1	1	0.009	0.7593	15.39	0.009	0	0	2	0.065	0.789	32801.77	0.631	0
END MLRZ1	1	-0.206	0.70544	0	0	0	0	-1	0.059	0.85	30474.88	0.646	0
END PRE-ANOXIC1	1	0.05	0.32824	1.043	0.05	0	0	2	0.079	0.519	14179.82	0.457	0
grit chamber #1	W	0.605	1.15678	0.086	0.605	0	0	2	0.613	0.084	49972.87	0.206	0
MLC PRE SPLIT 1	W	1.436	1.50058	0.152	1.436	0	0	2	1.48	0.146	64825.14	0.555	0
PC T 1 Aft Weir	W	1.867	0.5654	0.008	1.867	0	0	2	1.868	0.008	24425.21	0.032	0
PC T 1 OUT	W	0.108	0.5654	0.246	0.108	0	0	2	0.109	0.243	24425.21	0.196	0
PCT 1 & 2 OR	W	1.436	1.1329	0.07	1.436	0	0	2	1.446	0.069	48941.42	0.261	0
SC #1	W	-0.523	0.28306	0	0	0	0	-1	0.01	0.85	12228.28	0.267	0
SC 1 OR	W	1.03	0.38806	0.065	1.03	0	0	2	1.038	0.064	16764.28	0.204	0
uv bend 1	W	1.386	0.51813	0.071	1.386	0	0	2	1.395	0.071	22383.4	0.261	0
UV W 2	W	-0.084	0.51813	0	0	0	0	-1	0.266	0.85	22383.4	1.372	0

Table 13.4 - Model Output Data - 300 ML/d with River at 228.0 m - Gates, Screens, and Orifices

Part A: GATES																				
US Node ID	Link Suffix	DS Depth (m)	DS Flow (m3/s)	DS Froude number	DS Velocity (m/s)	Hydraulic Gradient	Max DS Depth (m)	Max DS Flow (m3/s)	Max DS Froude number	Max DS Velocity (m/s)	Max Surcharge State	Max US Depth (m)	Max US Flow (m3/s)	Max US Froude number	Max US Velocity (m/s)	Surcharge State	US Depth (m)	US Flow (m3/s)	US Froude number	US Velocity (m/s)
20		2.122	1.33512	0.077	0.35	0	2.122	1.33512	0	0	2	2.134	1.33512	0	0	2	2.134	1.33512	0.076	0.348
DIS CHAN 2	3	2.149	1.33512	0.075	0.345	0	2.149	1.33512	0	0	2	2.161	1.33512	0	0	2	2.161	1.33512	0.075	0.343
INLET STRUC	1	-2.61	0	0	0	0	0	0	0	0	-1	0	0	0	0	2	0	0	0	0
LOWFLOWCHNLBEND2	1	2.048	1.15678	0.277	0.83	0	2.048	1.15678	0	0	2	2.118	1.15678	0	0	2	2.118	1.15678	0.277	0.83
PC T 1 IN 2	S	1.409	0.28267	0.207	0.507	0	1.409	0.28267	0	0	2	1.435	0.28267	0	0	2	1.435	0.28267	0.207	0.507
uv bend 3	1	1.179	1.00722	0.183	0.623	0	1.179	1.00722	0	0	2	1.216	1.00722	0	0	2	1.216	1.00722	0.175	0.604
UV Inflow	1	1.396	1.00643	0.142	0.526	0	1.396	1.00643	0	0	2	1.423	1.00643	0	0	2	1.423	1.00643	0.138	0.516
Part B: SCREENS																				
US Node ID	Link Suffix	DS Depth (m)	DS Flow (m3/s)	DS Froude number	DS Velocity (m/s)	Hydraulic Gradient	Max DS Depth (m)	Max DS Flow (m3/s)	Max DS Froude number	Max DS Velocity (m/s)	Max Surcharge State	Max US Depth (m)	Max US Flow (m3/s)	Max US Froude number	Max US Velocity (m/s)	Surcharge State	US Depth (m)	US Flow (m3/s)	US Froude number	US Velocity (m/s)
19	B	2.134	1.33512	0.076	0.348	0	2.134	1.33512	0	0	2	2.149	1.33512	0	0	2	2.149	1.33512	0.075	0.345
Part C: ORIFICES																				
US Node ID	Link Suffix	DS Depth (m)	DS Flow (m3/s)	DS Froude number	DS Velocity (m/s)	Hydraulic Gradient	Max DS Depth (m)	Max DS Flow (m3/s)	Max DS Froude number	Max DS Velocity (m/s)	Max Surcharge State	Max US Depth (m)	Max US Flow (m3/s)	Max US Froude number	Max US Velocity (m/s)	Surcharge State	US Depth (m)	US Flow (m3/s)	US Froude number	US Velocity (m/s)
26	1	1.473	2.2929	0	2.919	0	1.473	2.2929	0	0	2	2.342	2.2929	0	0	2	2.342	2.2929	2.2929	99053.42
MLC SPLIT 1	O	1.038	0.38806	0	1.976	0	1.038	0.38806	0	0	2	1.436	0.38806	0	0	2	1.436	0.38806	0.38806	16764.28
PC IN SPLIT	O	1.446	1.1329	0.132	0.499	0	1.446	1.1329	0	0	2	1.47	1.1329	0	0	2	1.47	1.1329	1.1329	48941.42
PEC2	1	1.215	0.49644	0	2.528	0	1.215	0.49644	0	0	2	1.867	0.49644	0	0	2	1.867	0.49644	0.49644	21446.08