

Field Notes for Installation:

Before 2nd pole back from train overpass.

Pole Site Location N/S Pioneer Av west of Waterfront Dr

Sign Panel	Panel Type
PiW3	A logo

Pole Type **A**

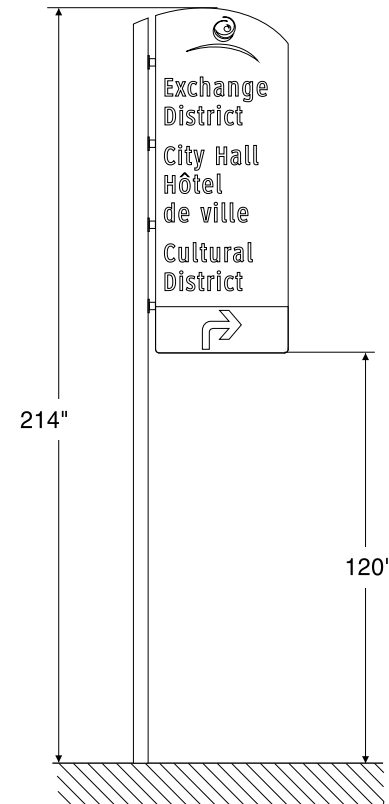



Field Notes for Installation:

In median in front of light pole. Sign edge 2' from curb edge.
Remove existing signs in median.

Pole Site Location S/S Pioneer Av east of Waterfront Dr

Sign Panel Panel Type

PiW2 **D logo**

Pole Type **D**

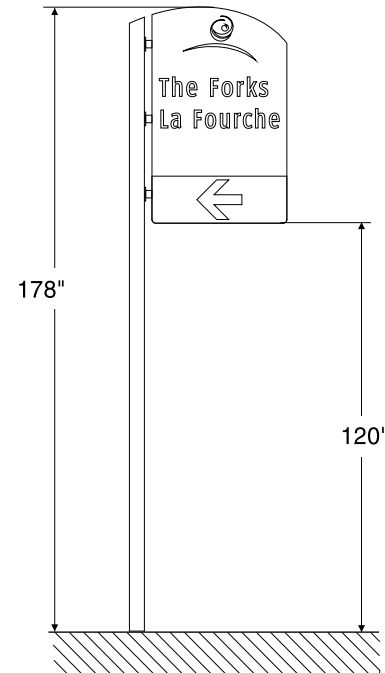

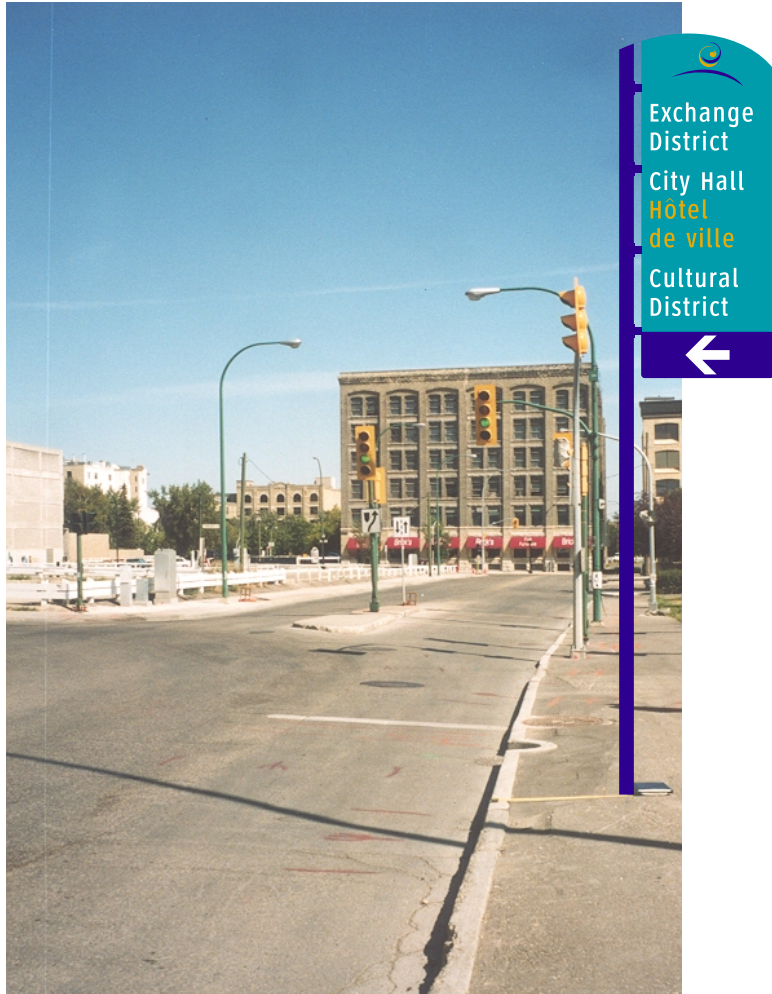

Field Notes for Installation:
35' back from corner.

Pile Site Location E/S Westbrook St south of
Portage Av E.

Sign Panel	Panel Type
PiW3-F	A logo

Pole Type **A**

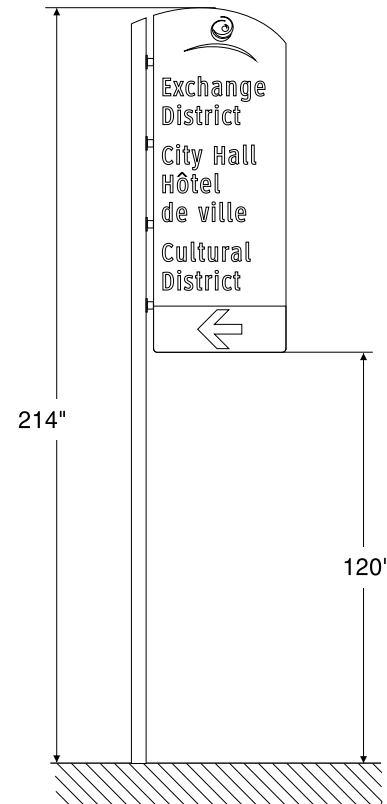



Field Notes for Installation:

Left side 60' beyond Westbrook where sidewalk narrows, pole to left.

Pole Site Location N/S Pioneer Av east of Main St

Sign Panel Panel Type

PiW5 **B "P"**

Pole Type **B**

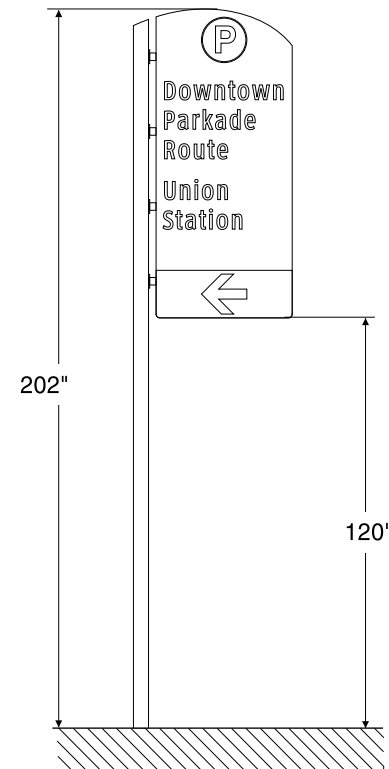



Field Notes for Installation:

Basically just a repeat of PiW5, but have a “left around barrier” symbol, 20' beyond driveway entrance to lot on left side.

Pole Site Location S/S Pioneer Av east of Westbrook St

Sign Panel	Panel Type
PiW6	B “P”

Pole Type **B**

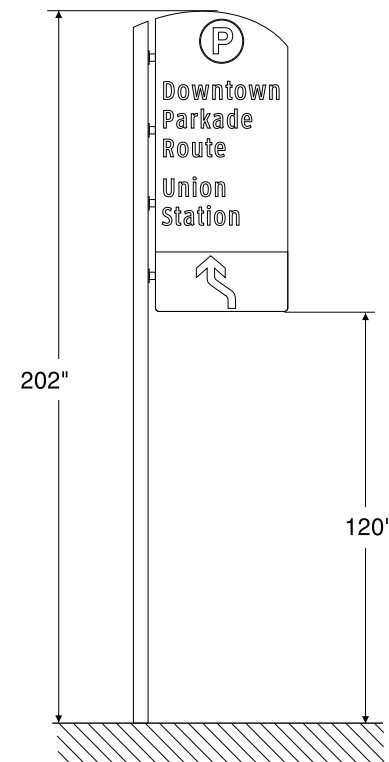

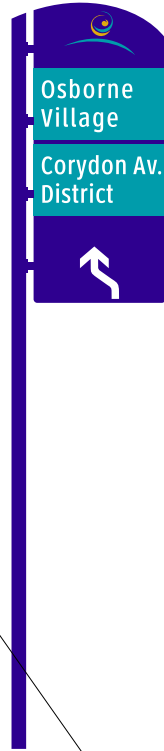
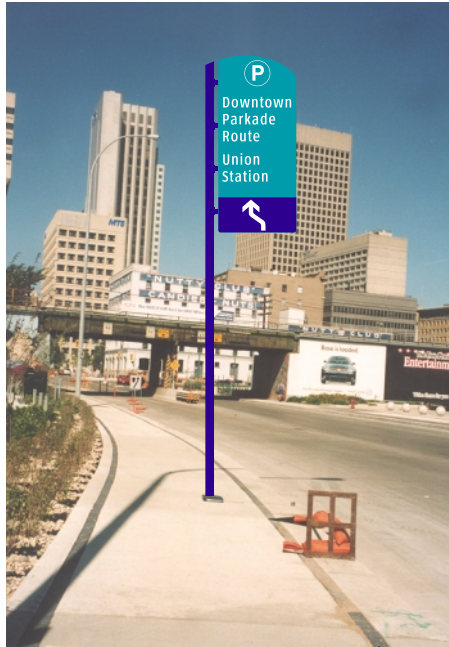

Pole Site Location S/S Pioneer Av east of Westbrook St

Sign Panel	Panel Type
PiW6a	B logo

Pole Type **B**

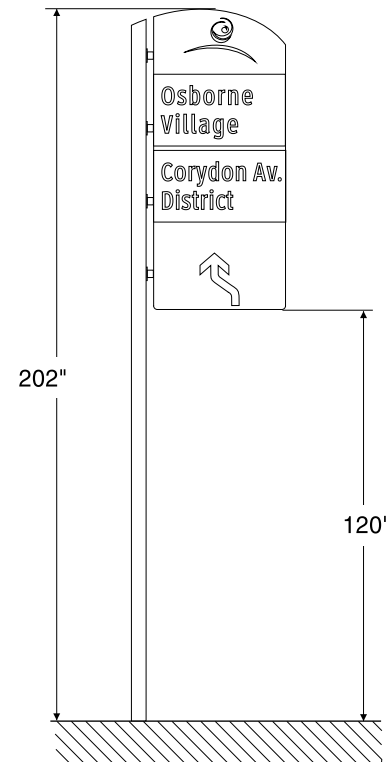

Field Notes for Installation:

Place before PiW6, on left side of Pioneer, across from PiW3.



Field Notes for Installation:

At corner of former Bank of Canada.

Pole Site Location N/S Portage Av E. east of Main St

Sign Panel Panel Type

PW2 **A logo**

Pole Type **A**

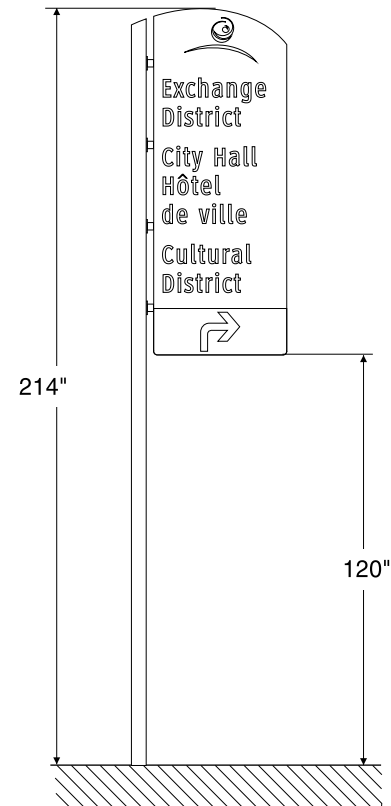



Field Notes for Installation:

44' back from Notre Dame corner.

Pole Site Location N/S Portage Av west of Main St

Sign Panel Panel Type

PW3 **D logo**

Pole Type **D**

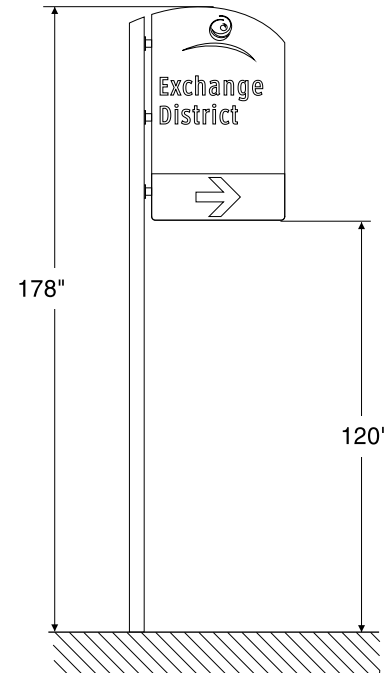



Field Notes for Installation:

35' back from corner, just after entrance, remove existing "P" sign.

Pole Site Location N/S Notre Dame Av west of

Portage Av

Sign Panel	Panel Type
PW3-F1	D "P"

Pole Type **D**

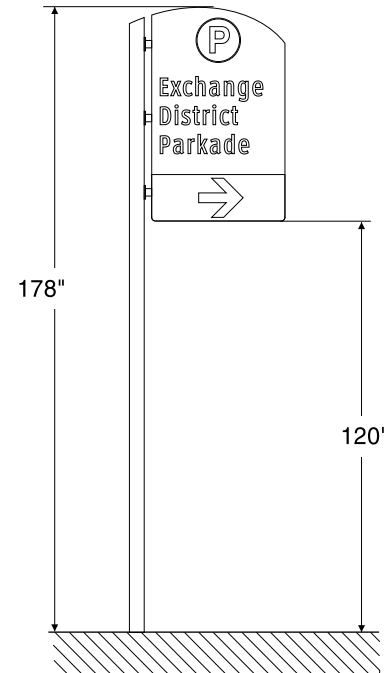

Pole Site Location E/S Albert St north of Notre Dame Av

Sign Panel	Panel Type
------------	------------

PW3-F2	D "P"
---------------	--------------

Pole Type	D
-----------	----------



Field Notes for Installation:

6' beyond driveway entrance.

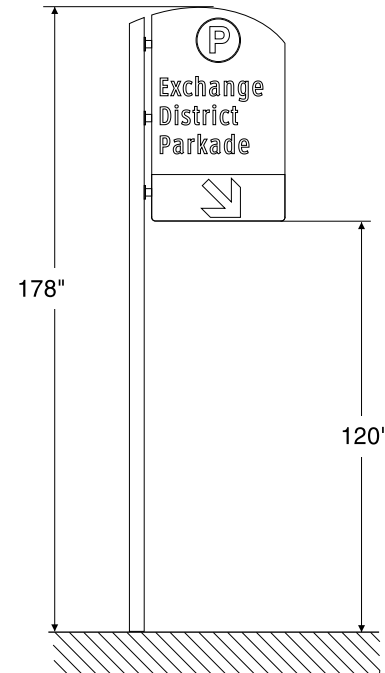



Field Notes for Installation:

In line with 3rd light pole back (the one with "Rt. 42" sign on it), 2' from curb.

Pole Site Location N/S Portage Av west of Garry St

Sign Panel Panel Type

PW4 **D "P"**

Pole Type **D**

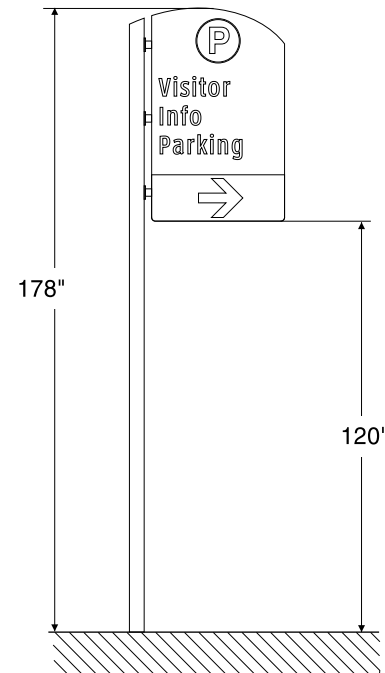

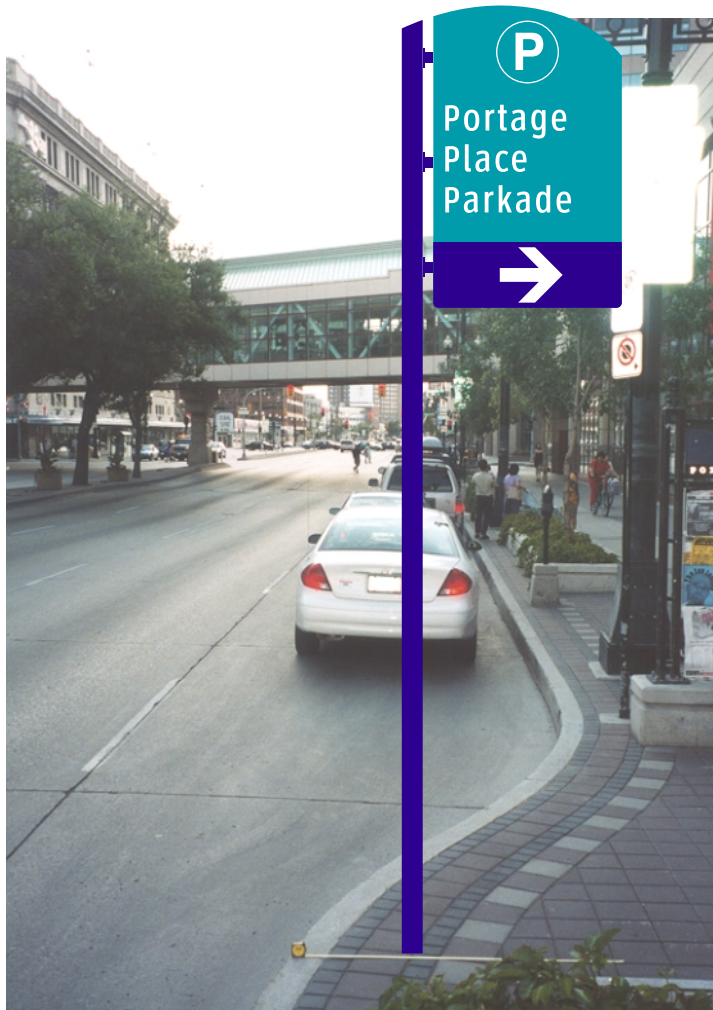

Field Notes for Installation:

Just beyond planter, after light on outcropping.

Pole Site Location N/S Portage Av east of Vaughan St

Sign Panel Panel Type

PW5 **D "P"**

Pole Type **D**

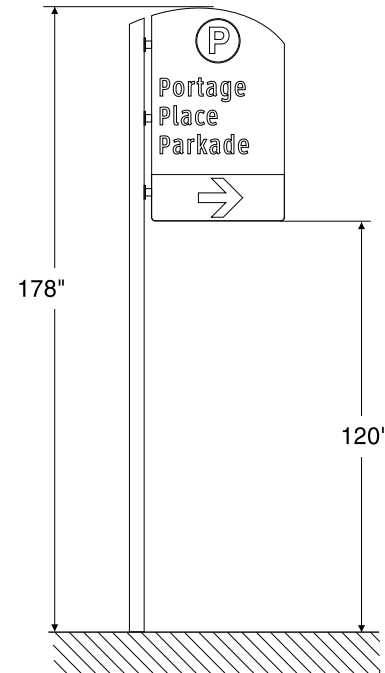



Field Notes for Installation:

In island, 2' in from curb — remove existing illuminated “P” sign.

Pole Site Location E/S Vaughan St north of
The Promenade

Sign Panel	Panel Type
PW5-F1	D “P”

Pole Type **D**

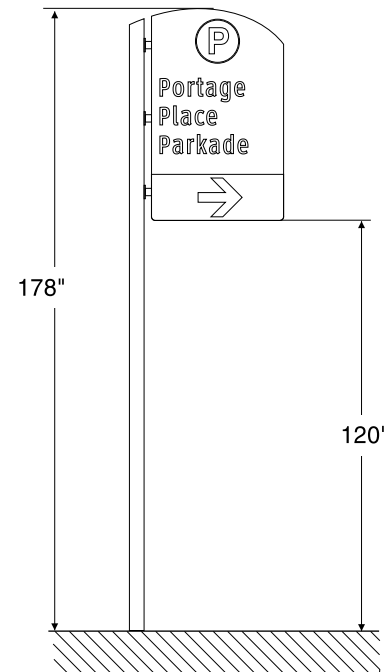



Field Notes for Installation:

To left of garage entrance in line with light pole immediately to right of bollard.

Note to Portage Place: add "No Pedestrians" sign?

Pole Site Location S/S The Promenade east of Vaughan St

Sign Panel	Panel Type
------------	------------

PW5-F2	D "P"
---------------	--------------

Pole Type	D
-----------	----------

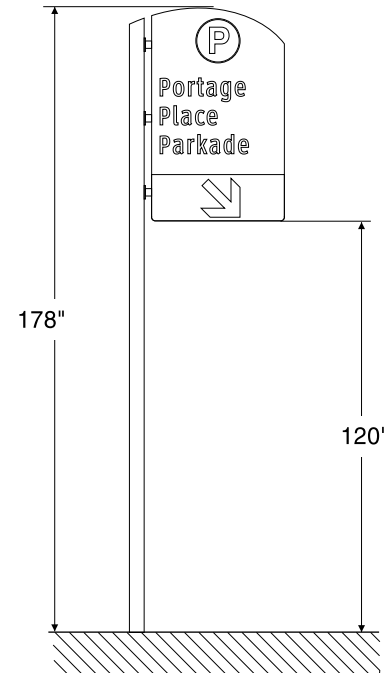

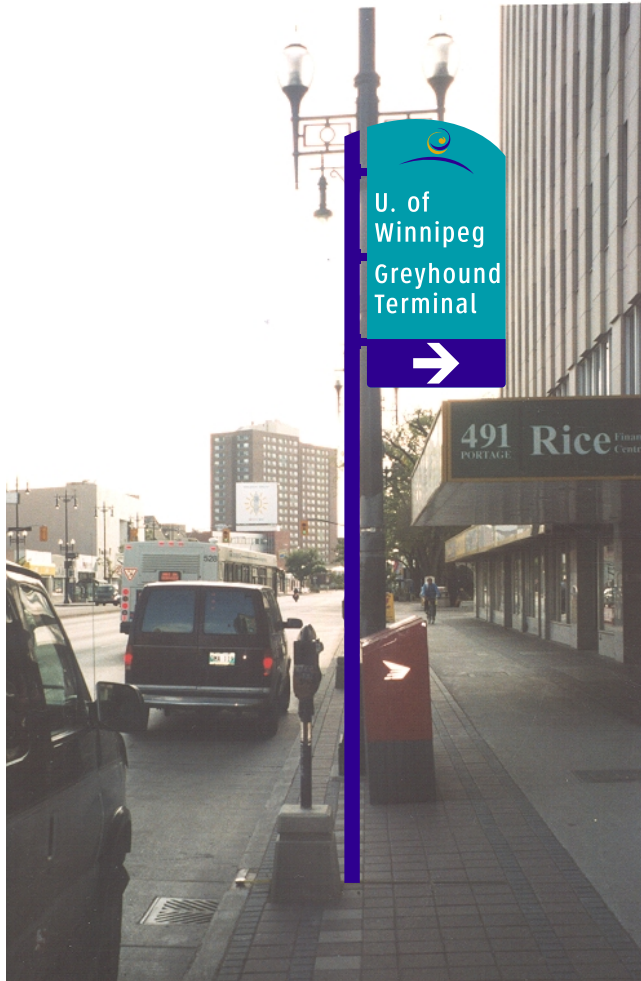

Field Notes for Installation:

In front of parking meter, in front of light at Rice Fin. Ctr. sign.

Pole Site Location N/S Portage Av west of Colony St

Sign Panel Panel Type

PW6 **C logo**

Pole Type **C**

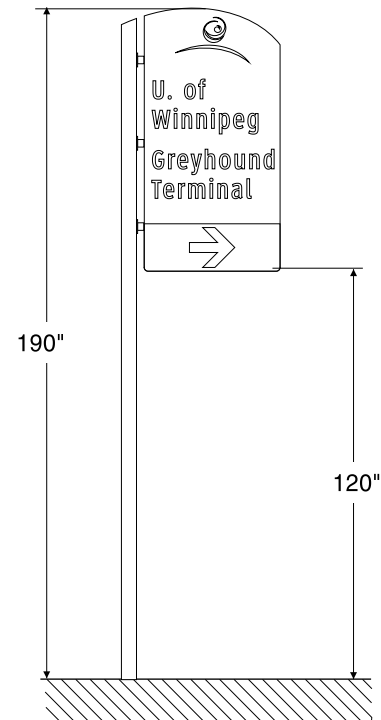



Field Notes for Installation:

Place just behind transit signs pole, this sign at least 1' above top transit sign.
 No follow-up needed on Colony at terminal — big neon sign already there.

Pole Site Location E/S Balmoral St south of Ellice Av

Sign Panel	Panel Type
PW6-F	D logo

Pole Type	D
-----------	----------

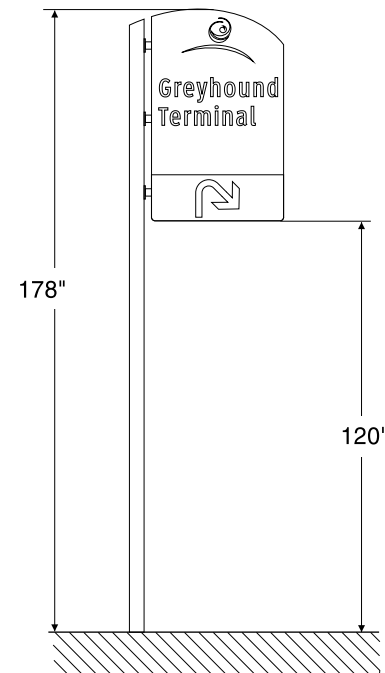



Pole Site Location N/S Portage Av east of Colony St

Sign Panel	Panel Type
PW7	B logo

Pole Type **B**

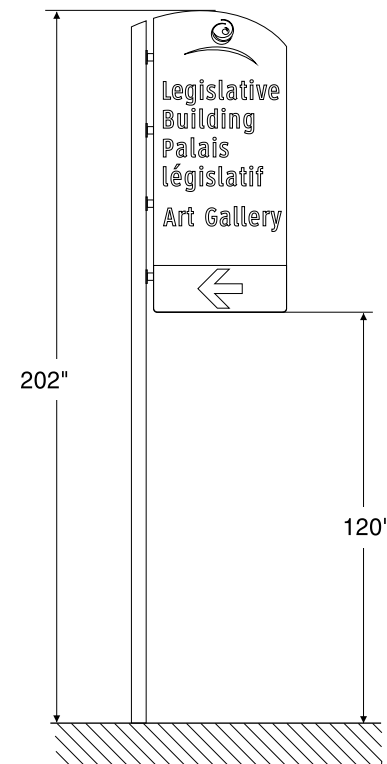

Field Notes for Installation:

In front of pole with star attraction signs (remove) — 2nd light pole after Vaughan.

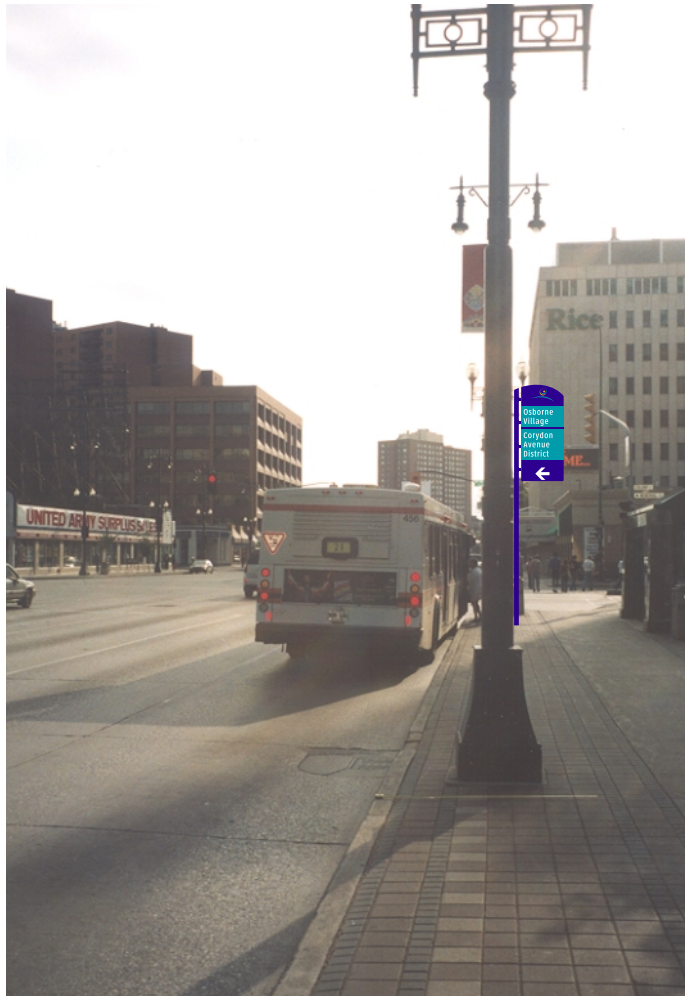

Pole Site Location N/S Portage Av west of Vaughan St

Sign Panel Panel Type

PW8 **B logo**

Pole Type **B**

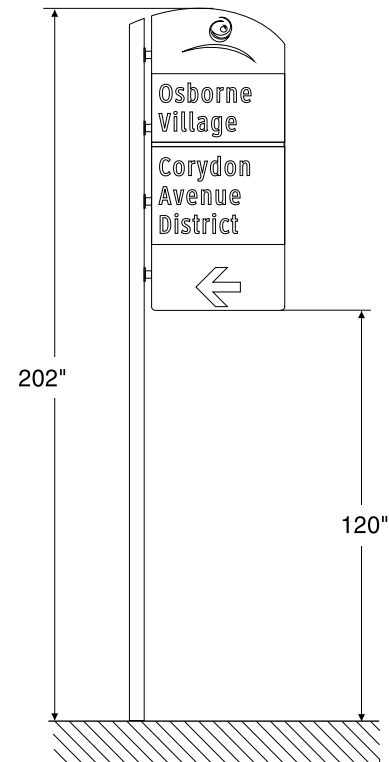

Field Notes for Installation:

In front of 3rd light pole after Vaughan.



Field Notes for Installation:

At light pole just beyond pedestrian crossing to Bay.

Pile Site Location W/S Memorial Blv south of Portage Av

Sign Panel	Panel Type
PW8-F-U	D logo
PW8-F-L	C lower
Pole Type	D+C

