



DILLON
CONSULTING

CITY OF WINNIPEG

Winnipeg Transit Fort Rouge Garage – Hydrogen Infrastructure

FINAL



June 21, 2021



Winnipeg Transit
421 Osborne Street
Winnipeg, Manitoba
R3L 2A2

Attention: Erin Cooke, P.Eng.

Winnipeg Transit Fort Rouge Garage – Hydrogen Infrastructure – FINAL

Dillon Consulting Limited (Dillon) is pleased to submit the following report of our findings and recommendations on the Hydrogen Infrastructure of the Winnipeg Transit Fort Rouge Garage.

We look forward to your review, should you have any questions or comments, please contact the undersigned at (204) 453-2301 or via email at jyablecki@dillon.ca.

Sincerely,

DILLON CONSULTING LIMITED

A handwritten signature in black ink, appearing to read "J Yablecki", is written over the printed name.

Jessica Yablecki, P.Eng.
Project Manager

JCY:bg

Our file: 21-1393

1558 Willson Place
Winnipeg, Manitoba
Canada
R3T 0Y4
Telephone
204.453.2301
Fax
204.452.4412

Table of Contents

1.0	Background	1
2.0	System Requirements	2
2.1	Overview	2
2.2	Codes and Standards	2
2.3	Site Layout and Setbacks	3
2.4	Installation Requirements	4
2.4.1	Potable Water	4
2.4.2	Drainage	4
2.4.3	Electrical and Communications	4
2.4.4	Station Safety	5
2.4.5	Other	6
3.0	Proposed Installation	7
3.1	Site Preparation	7
3.1.1	Civil	7
3.1.2	Electrical	7
3.2	Station Installation	7
3.2.1	Hydrogen Production Equipment	8
3.2.2	Hydrogen Fuel Station	9
3.2.3	General Contractor Scope	11
3.2.4	Other Equipment Suppliers	11
4.0	Operating Requirements	13
4.1	Scheduled Maintenance	13
4.1.1	Overall Maintenance Requirements	13
4.1.2	Hydrogen Production Package	13
4.1.3	Hydrogen Storage and Fuel Dispensing Package	14
4.2	Annual Inspections and Reporting	14

4.3	Lifecycle Overview.....	14
5.0	Costing	16
<hr/>		
Figures		
<hr/>		
	Figure 1: Required Clearances for Parked Vehicles	4
<hr/>		
Tables		
<hr/>		
	Table 1: Applicable Exposures and Minimum Clearances	3
	Table 2: Equipment Anticipated Service Life	14
<hr/>		
Appendices		
<hr/>		
A	Class 3 Cost Estimate (-20% to +30%)	
B	Drawings	
C	Equipment Specification Sheets	
D	Equipment Maintenance Schedules	

1.0 Background

Dillon Consulting Limited (Dillon) was retained by the City of Winnipeg Transit department (Winnipeg Transit) to provide an assessment and Class 3 Cost Estimate for the infrastructure costs associated with the installation of a 350 bar hydrogen dispensing and production station to serve Winnipeg Transit's Fort Rouge Garage (FRG) at 421 Osborne Street. The following report summarizes the proposed installation including the site works and equipment required to produce, compress, store and dispense hydrogen to a test fleet of buses.

2.0 System Requirements

2.1 Overview

The hydrogen infrastructure outlined in this design memo has been sourced in accordance with the following technical requirements provided in the RFP:

- Production of 400 kilogram (kg)/day of hydrogen;
- Operate in temperatures of -40°C to 40°C;
- Options for 500 kg and 1,000 kg of storage (500 kg is upgradable to 1,000 kg at a later date); and
- Able to accommodate both 40-foot and 60-foot buses which have curb weights up to 16,000 kg and 25,000 kg, respectively.

2.2 Codes and Standards

The following are the primary applicable codes and standards for hydrogen fuelling and production infrastructure:

- CAN/BNQ 1784-000 – The Canadian Hydrogen Installation Code Standard. This code sets the installation requirements for hydrogen generating equipment, hydrogen utilization equipment, hydrogen dispensing equipment, hydrogen storage containers, hydrogen piping systems and their related accessories;
- NFPA 2 – Hydrogen Technologies Code – This code provides fundamental safeguards for the generation, installation, storage, piping, use and handling of hydrogen in compressed gas form or cryogenic liquid form;
- CSA – C22.1 Canadian Electrical Code;
- ASME B31.12 – Hydrogen Piping and Pipelines – This standard contains requirements for piping in gaseous and liquid hydrogen service and pipelines in gaseous hydrogen service;
- ASME B31.3 – Process Piping – This standard covers materials and components, design, fabrication, assembly, erection, examination, inspection and testing of piping;
- CSA B51 – Boiler, Pressure Vessel and Pressure Piping Code – This code contains the requirements for boilers, pressure vessels, pressure piping and fittings. It is intended mainly to fulfill two (2) objectives:
 - To promote safe design, construction, installation, operation, inspection, testing and repair practices; and
 - To facilitate adoption of uniform requirements by Canadian jurisdictions.
- SAE J2579 – Standard for Fuel Systems in Fuel Cell and Other Hydrogen Vehicles and SAE J2600 – Compressed Hydrogen Surface Refueling Connection Devices – These standards are referenced in relation to the dispensing and filling requirements for the vehicles; and

- CGA G5.5 – Hydrogen Vent Systems – This is a design guideline for hydrogen vent systems used in gaseous and liquid hydrogen systems at user sites and provides recommendations for safe operation of these vents.

2.3 Site Layout and Setbacks

The land at 421 Osborne Street is currently zoned as C3 (Commercial Corridor). Dillon reviewed the proposed hydrogen infrastructure with the City of Winnipeg’s Planning, Property and Development Office to assist in determining the appropriate use category. The proposed hydrogen infrastructure would be considered “Major Utility Facility” use which has limited permitted zoning districts (M2 and M3) and condition use districts (A, MMU, M1). The City of Winnipeg (the City) Planning Department indicated that an accessory use classification to the existing C3 zoning would be considered. This would allow the land to remain as C3 and avoid rezoning. A detailed letter of intent and further discussion with the City’s Planning Department to review the proposed equipment and related safety items would be required.

The City zoning requirements for this proposed site require a 25 foot setback from the front of the lot (Osborne Street) and rear (transit corridor). There is no required setback from Brandon Avenue.

For outdoor gaseous hydrogen storage installations above 35 kg, minimum clearance distances from the equipment to a number of different exposures must be maintained as per CAN/BNQ 1784-000. The following Table 1 summarizes the applicable exposures for this application and the minimum clearance distances to be maintained.

Table 1: Applicable Exposures and Minimum Clearances

Exposure	Minimum Distance (m)
Building or Structure (Sprinklered)	1.5
HVAC Inlets	15.2
Wall Openings	7.6
Aboveground Flammable and Combustible Liquids (above 3,785 litres (L))	15.2
Public Sidewalks and Parked Vehicles	4.6

The proposed site is in accordance with the noted clearances related to the adjacent buildings and public sidewalks. The proposed site is within an existing parking lot. Along with the parking spaces that will be removed for the physical site, additional spaces within a set zone will also need to be removed to adhere to the requirements of CAN/BNQ 1784-000. Figure 1 highlights the impacted area.

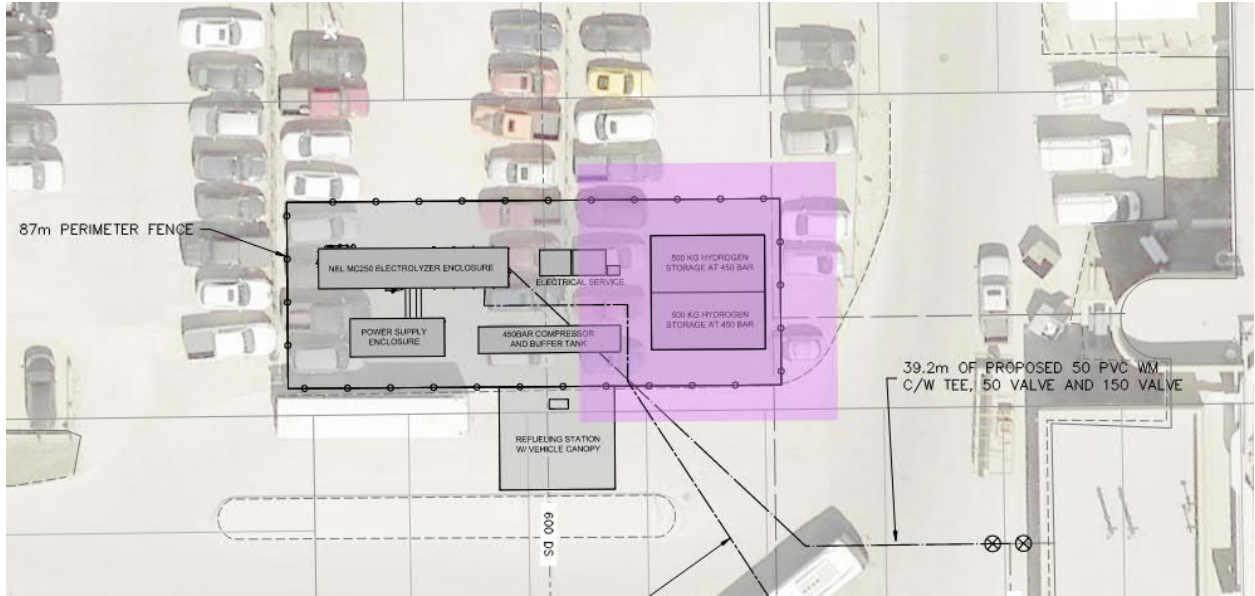

Figure 1: Required Clearances for Parked Vehicles

2.4 Installation Requirements

The following summarizes the site requirements for the installation.

2.4.1 Potable Water

Potable water is required for the electrolyzer. A water treatment skid is required to treat the water to the levels required for the electrolyzer equipment. It is estimated that 1.5 to 2 L of potable water will produce 1 L of pure process water required for the electrolysis equipment and 1 L of process water is required to produce 1 normal metre cubed (Nm^3) of hydrogen. The anticipated water usage at the site for full production (400 kg/day) would be 6,700 to 8,900 L/day with a peak flow of 35.2 gallons per minute (gpm).

2.4.2 Drainage

The electrolyzer equipment requires a sanitary drainage connection for equipment drainage and process drainage. The proposed site will also require grading for the installation and stormwater management.

2.4.3 Electrical and Communications

The total power requirements for the hydrogen infrastructure is 1,920 kVA at the beginning of operational life (BOL) to 2,080 kVA at the end of operational life (EOL) and is broken down as follows:

- 475 kW at 480 V:
 - 300 kW (Powertech compressors, chiller and controls);
 - 100 kW (NEL ancillary); and
 - 75 kW (NEL TCU cooling).

- 40 kW at 480 V back-up HVAC power;
- 1.25 to 1.4 MW at 25 kV (NEL Electrolyser (BOL to EOL)); and
- Power factor > 0.9.

An internet connection is required for communication and monitoring of the system.

2.4.4 Station Safety

CAN/BNQ 1784-000 sets out the installation requirements for the hydrogen generation, storage, piping and dispensing equipment. Included in the code is a number of safety requirements. The following summarizes the applicable requirements for the proposed installation.

2.4.4.1 Emergency Shutdown System (ESD)

An ESD system is required to promptly shut down part or all of the facility in the event of a hazardous condition occurring. Its location must be clearly identified.

2.4.4.2 Ground and Bonding

Along with meeting the requirements of CSA-C22.1 for the electrical equipment, the hydrogen containers, vent system, piping and flanges and dispensing equipment shall be electrically grounded and bonded.

2.4.4.3 Master Shutoff Valve

An approved manually and remotely activated master shutoff valve shall be installed at the outlet pipe immediately adjacent to the hydrogen storage.

2.4.4.4 Pressure Relief Devices

Pressure relief valves shall meet the requirements of ASME and be registered in accordance with CSA-B51 Part 1.

2.4.4.5 Hydrogen Vent Systems

The vent characteristics and location shall comply with CGA Standard G 5.5 and be installed in accordance with ASME B31.3 for the rated pressure, volume and temperature.

2.4.4.6 Signage

All hydrogen piping must be clearly identified.

Outdoor installations require signage identifying.

2.4.5 Other

The hydrogen equipment would qualify as “outside storage” (outside storage but not display for sale of goods and/or materials) per the City’s definitions. As such, it will require screening from any adjacent residential lots by a fence 6 feet high that meets the following requirements: “effectively screened from the view of the residential buildings by (a) an opaque fence or masonry wall at least 6 feet in height, or (b) a chain link fence with plastic slats at least 6 feet in height, or (c) a chain link fence bordered by coniferous trees and shrubs with an expected mature height at least equal to the height of the fence. The stored materials, inventory, or products within the enclosure must not exceed the height of the enclosure.” The fence along with all equipment enclosures shall be locked to prevent unauthorized access as per NFPA 2.

Concrete pads for the equipment will be required within the site. Specific details for the concrete requirements and associated reinforcement are provided in further detail under the applicable equipment sections.

Dillon provided an environmental file search review to determine if a Phase II Environmental Site Assessment (ESA) would be required at the property in our previous report. The site has historically contained soil exceedances for Petroleum Hydrocarbons (PHC), Polycyclic Aromatic Hydrocarbon (PAH) and/or metal parameters. Given the historical sites and surrounding land uses there is a potential for soil concentrations to exceed applicable site criteria, however, it is anticipated that the environmental exposure from the proposed construction would be minimal as the new construction would not include a habitable building, would be graded with new fill material and would be fenced with minimal access to the public. Dillon recommends that soil excavated and planned for removal from the site be stockpiled. This material could then be tested and determined if disposal at a waste disposal ground or licenced disposal facility would be required.

3.0 Proposed Installation

3.1 Site Preparation

3.1.1 Civil

Based on a review of the as-built drawings and utility data available, the proposed location will require approximately 40 metres (m) of piping to connect to the existing 350 Ø water main and 60 m of piping to connect to the existing 250 Ø sanitary system. The site will require grading to ensure it drains to the existing land drainage system. There is no anticipated rerouting of utilities (water, gas, drainage) in the area for the installation of the proposed equipment, however, the close proximity of existing utilities including natural gas lines to the proposed installations will require hand digging during the installation of the new utility lines. The site will require 87 m of perimeter fencing around the equipment.

3.1.2 Electrical

To meet the anticipated electrical demand outlined in Section 2.0, a three (3) phase 2,000 kVA service is required. At 421 Osborne Street there is a recently upgraded customer owned 25 kV three (3) phase service which feeds four (4) customer owned 25/0.6 kV transformers. Based on the current demand, it is estimated that the existing utility service infrastructure is sufficient to allow for the addition of the proposed hydrogen infrastructure.

Given that the service is already customer owned, a utility service upgrade is not anticipated, however, there would be added complexity with connecting into the existing 25 kV service loop that may result in downtime for the existing service. The required service infrastructure upgrades would include connecting to the existing 25 kV service loop with approximately 40 m of buried 25 kV loop feed. The electrolyser site would require a 25 kV switchgear, 25/0.48 kV transformer, 600/480 V transformer, 480 V distribution panels as well as all associated conduit and cabling.

A 600 V back-up power feed of 40 kVA is required for the Electrolyser HVAC system. This feed will connect to the 600/480 V transformer noted above.

One (1) or two (2) 12-strand fibre optic cables, depending on existing network architecture, will be run to the hydrogen station control equipment for connection to transit communication systems.

3.2 Station Installation

The equipment required to produce, compress, store and dispense fuel for the test fleet of buses is broken down into two (2) main areas; Hydrogen Production and Hydrogen Fueling Station based on what is currently available in the market. The equipment outlined in the following sections is based on

NEL and Powertech – two (2) established providers of hydrogen equipment within North America. We have also reviewed products from other suppliers for all of the main components and have included a summary of this equipment in Section 3.2.4.

A proposed layout for the station is provided in Appendix B. It is based on equipment footprints and clearance requirements provided by the suppliers.

3.2.1 Hydrogen Production Equipment

The hydrogen generation equipment is based on the NEL Proton PEM water electrolyser MC250. The system is a containerized installation with a production rate of 531 kg/day and operating pressure of 30 bar. The expected power consumption for the unit is 5.4 kWh/Nm³.

The standard operation range for the equipment is -30°C to 40°C. The system will require additional heating or alternate components to maintain operations to -40°C. Specifically it is the standard electrical components that are only rated to -30°C. NEL indicated this would require a specific engineering solution that would be reviewed as the design progresses. Additional costs are anticipated but specific quantities could not be provided at this time.

Included in the pricing from NEL is the containerized electrolysis system and a separate electrical container complete with all MV transformers, rectifiers, MCCs, PLC controls. The electrolysis system includes a water and oxygen management system, RO/EDI water purification system and a roof mounted dry cooler for process cooling. The piping and wiring within and between the containers is provided under NEL's scope.

NEL will provide all required safety equipment as prescribed by code within their enclosures including a hydrogen vent and detection system.

The product lead time is months from ordering. The system is provided with a 12 month warranty from start-up and commissioning.

The enclosures would be installed on a reinforced concrete slab foundation supported by cast-in-place concrete friction piles. A void slab will be provided below the structural slab to mitigate slab damage and movements due to native soil expansive properties. Two (2) separate pads, one (1) for each container, are proposed. Pricing for these is separate from the NEL costing and included in Appendix A.

Refer to Appendix C for the equipment specifications provided by the supplier.

3.2.2 Hydrogen Fuel Station

The Hydrogen Fuel Station includes the equipment required to compress, store and dispense the system and can be provided by a single supplier. PowerTech and NEL have worked together on a number of installations in North America.

Compressor controls and vehicle fueling is automated using a PLC. Remote monitoring capabilities are provided to allow viewing of the station's status and performance along with historical data.

The compressing and control equipment is housed in custom built enclosures provided by Powertech. The enclosures are designed to allow outdoor installations in temperatures from -40°C to 40°C.

The lead time for the system from Powertech is 14 to 16 months after receipt of a signed equipment purchase order.

Refer to Appendix C for the equipment specifications provided by the supplier.

3.2.2.1 Compression Equipment

The hydrogen is produced at 30 bar by the NEL electrolyzer. Compression to 450 bar is required for the onsite storage. This is achieved with one (1) or two (2) reciprocal compressors and a buffer tank. The anticipated energy use for current compression equipment is 2.23 kilowatt-hour (kWh)/kg hydrogen for compression to 450 bar.

The compression equipment from Powertech will be installed in an enclosure approximately 30 feet by 9 feet by 9 feet. The enclosure would be installed on a reinforced concrete slab foundation supported by cast-in-place concrete friction piles. A void slab will be provided below the structural slab to mitigate slab damage and movements due to native soil expansive properties. Pricing for this is outside of Powertech's scope and included in Appendix A.

3.2.2.2 Storage Equipment (Options for 500 kg or 1,000 kg of Above-Ground Hydrogen Storage)

The hydrogen will be stored on site at 450 bar. Pressure vessels designed specifically for storage at high pressure and meeting ASME UPV Code Section VIII Division 1 for hydrogen service are recommended. The 450 bar storage tanks from Powertech will be plumbed in separate high, medium and low banks with a total initial capacity of 500 kg. The installation will be approximately 12 feet by 24 feet. An additional 500 kg of storage can be added to the site at a later date. The pricing in Appendix A has been broken out to show the cost for the additional 500 kg of storage.

An additional pricing breakdown has been provided in Appendix A for an initial capacity of 300 kg of storage. This would be the minimum amount of storage recommended for the initial test fleet of four (4) to eight (8) buses that would allow for back to back filling.

Storage containers shall have a Canadian Registration Number (CRN) and registered in accordance with CSA-B51 Part 1 and certified to ASME.

In accordance with BNO, reinforced concrete pads will be provided for the hydrogen storage equipment. The layout and pricing has been provided for the final installation of 1,000 kg. The following structural installation is proposed:

- Reinforced concrete slab foundation (at grade) supported by cast-in-place concrete friction piles;
- Slab plan dimensions 7.5 m by 7.5 m; and
- Void slab below structural slab to mitigate slab damage and movements due to native soil expansive properties.

3.2.2.3 350 Bar Fueling Station

Hydrogen will be provided to the vehicles with one (1) stand-alone 350 bar dispenser. The dispenser designed by Powertech includes a flow meter, flow controller and the hose, breakaway and heavy duty nozzle assembly. It is provided with a display screen with fill details.

A closed-loop cooling system is provided to reduce temperatures to enable faster fill in accordance with SAE J2601 at 37°C. The communication to the fuel dispensing station is wireless using IRDA. The chiller installation is included within Powertech's scope and pricing.

A weather canopy is recommended and shown in the proposed layout for the dispenser. This is separate from the Powertech equipment and would be provided by the general contractor during the site installation works.

3.2.2.4 Station Safety

Powertech includes the following safety features within their equipment:

- Continuous monitoring for hydrogen gas leaks and fire within all station containment;
- Pressure sensors and monitoring throughout the system;
- Temperature sensors and monitoring at key locations
- ESD in required areas;
- External alarm lists and audible alarms; and
- Pressure relief valves on storage equipment and key locations as required.

Powertech provides a risk assessment and HAZOP for all installations. A detailed description of all safety systems is provided to operators.

3.2.3 General Contractor Scope

A general contractor will be required to perform on site installation of the hydrogen generation, storage and dispensing equipment. Their Scope will include: Site installation of equipment, Site purging of equipment, On-site hydrogen and coolant line connections, Onsite electrical and water connections and terminations and vent stack installation, in addition to other installation items as required.

All exterior piping will be designed for -40°C to 85°C operation in accordance with CAN/BNQ 1784-000. The piping and fittings will be designed and installed in accordance with the requirements of ASME B31.3 and registered in accordance with CSA-B51 Part 1. Hydrostatic pressure testing of the piping is required prior to start-up.

3.2.4 Other Equipment Suppliers

In addition to Nel and Powertech, Dillon also evaluated hydrogen equipment from Next Hydrogen (alternative electrolyzer), CPI Industries (hydrogen storage) and ComTech (dispensing).

Next Hydrogen is a Canadian designer and manufacturer of hydrogen electrolyzers. Their equipment is designed to be highly responsive to dynamic electrical inputs, and is optimized for hydrogen production from renewable energy sources such as solar PV or wind. During steady state operation, they are not as efficient as the Nel electrolyzer described herein. Their cost is comparable to the Nel product.

CPI Industries was consulted to provide an independent quote and technical specifications for the hydrogen storage. Pricing aligns with the quote from PowerTech.

ComTech was consulted to provide information and pricing on dispensing equipment. They have provided equipment in a number of Canadian and North American installations. They were able to provide insight into the specific maintenance requirements for the dispensing equipment.

3.2.4.1 Licensing and Permitting

Inspection and Technical Services (ITS) is in charge of inspections related to pressure equipment in Manitoba that falls under the Steam and Pressure Plants Regulation C.C.S.M. c. S21. An initial inspection is required by an Inspector from ITS with recurring inspections at a specified interval. Hydrogen installations are not specifically included in the regulations but based on preliminary discussions with ITS, their standard pricing is \$323.00 per vessel and \$140.00 per hour for pressure piping. Additional pricing may be applied given the nature of the installation but this information was not available from ITS at this time.

A \$10,000.00 allowance has been provided in the overall cost estimate to cover additional construction permit requirements.

3.2.4.2 Commissioning and Training

An operations and maintenance manual will be supplied for the station, including separate compressor manuals. The operations and maintenance manual will include detailed information on the station, including component specifications, HMI display screenshots with detailed guidance on HMI use, a troubleshooting guide to assist with unplanned maintenance, and an emergency procedures guide.

4.0 Operating Requirements

4.1 Scheduled Maintenance

4.1.1 Overall Maintenance Requirements

CAN/BNQ 1784-000 requires that all installations have a maintenance program in place. Specific maintenance requirements for the equipment provided from Nel and Powertech are outlined below as well as the specific requirements from CAN/BNQ 1784-000.

- Monthly:
 - Drain compressor recovery tank;
 - Verify compressor operation;
 - Verify all components with expiry dates and replacement as required; and
 - Verify fueling hose and nozzle are in good condition (visual).
- Quarterly:
 - Visually inspect all pressure-relief devices;
 - Verify correct functioning of all visual and audible alarm;
 - Verify correct function of ESD system;
 - Inspect and lubricate dispense breakaways; and
 - Observe a fuelling process for the dispenser hose to ensure compliance.
- Semi-Annually:
 - Verify correction function and calibration of hydrogen detection system.
- Annually:
 - Check set points and calibrate all instrumentation (pressure, temperature, etc); and
 - Leak test all piping and tubing and verify absence of leaks.
- Five (5) Years:
 - Recertify all pressure-relief valves.

4.1.2 Hydrogen Production Package

A detailed maintenance schedule for the MC250 is attached as Appendix D. The supplier will train the local operators on all maintenance procedures during the start-up and commissioning period. The maintenance training will be done during the start-up and commissioning period. There is no special training beyond the training provided by the supplier and a standard local technician can perform all the PM maintenance once they have completed the supplier provided training. Alternatively, the supplier can perform the maintenance under a PM contract if requested to do so.

Supplier technicians are available on a daily basis, at \$2,725.00 USD/day, to perform the annual preventative maintenance, Item 4 of the A_08 attachment. To contract for the annual PM, we

recommend budgeting three (3) days to cover all the maintenance procedures and any additional refresher training for the local operators.

NEL recommends that the operator maintain an inventory of recommended spare parts to prevent shutdowns and delays with shipping. The typical cost of this inventory is \$58,000.00.

4.1.3 Hydrogen Storage and Fuel Dispensing Package

An operations and maintenance manual will be supplied for the storage and fueling station, including separate compressor manuals. The operations and maintenance manual will include detailed information on the station, including component specifications, HMI display screenshots with detailed guidance on HMI use, a troubleshooting guide to assist with unplanned maintenance and an emergency procedures guide.

Additional training can be provided by the supplier if required. Alternatively, the supplier can perform the maintenance if requested to do so. An annual cost of \$44,000.00 for maintenance labour, technician and engineering support, should be budgeted. This does not include travel costs and accommodations. An additional \$15,000.00 to \$20,000.00 annually should be budgeted for routine replacement parts and materials. This does not include costs for larger replacements and equipment overhaul.

A detailed maintenance schedule for the dispenser is provided in Appendix D.

4.2 Annual Inspections and Reporting

ITS requires recurring inspections of all pressure equipment. An expected interval of 36 to 60 months for recurring inspections of the pressure vessels and pressure piping is noted. Similar to the initial inspection costs, pricing is \$323.00 per vessel and \$140.00 per hour for pressure piping.

4.3 Lifecycle Overview

The anticipated service life of the major equipment is summarized in Table 2. This information was obtained from equipment suppliers and available published data.

Table 2: Equipment Anticipated Service Life

Item	Anticipated Service Life	Notes
PEM Electrolyzer	20 years	Stack has a design life of 80,000 hours or ten (10) years, replacement should be planned.
Reciprocating Compressor	50,000 hours	
Chiller	20 to 25 years	
Storage Vessels	20 years	

Item	Anticipated Service Life	Notes
Hydrogen Dispenser	20 years	Preventative maintenance and replacement parts required over this life span.
Station Infrastructure	25 + years	
Electrical Equipment	25 + years	Not including consumables, circuit breakers and controls equipment.

The electrolyzer stack has a design life of 80,000 hours or approximately ten (10) years. NEL recommends budgeting for one (1) stack during the 20 year life span at an estimated budget cost of \$568,500.00.

The hydrogen dispensing equipment will require valve and hose rebuilds throughout the lifespan of the equipment. A budget of \$96,000.00 has been provided over the 20 years.

5.0

Costing

Dillon has developed a Class 3 estimate of costs for the proposed installation. The Class 3 estimate prepared in the Winnipeg Basis of Estimate document is provided in Appendix A. Preliminary budget numbers for the suppliers are included in the estimate along with an estimate for the site works and installation. A contingency of 15% has been included in the overall cost estimate. For the equipment provided by NEL, a US based company, an exchange rate of 1.21 was used based on a date of May 21, 2021.

Costing for two (2) scenarios have been provided based on the storage capacity. Costing for 300 kg and 1,000 kg of hydrogen has been provided.

Appendix A

Class 3 Cost Estimate (-20% to +30%)



Basis of Estimate Summary

Investment Title	Fort Rogue Garage Hydrogen Infrastructure
Investment Description	
Department	
Date	20-May-21
BoE Author	Jessica Yablecki
BoE Estimating Team	Dillon Consulting
BoE Reviewed by	Sean Russell
Business Case ID	

Investment Capital Cost Summary	
CAPITAL COSTS (\$000's)	
Construction/Equipment	\$8,057,860
Consultant	\$174,246
Utility	
Other	\$21,713
Contingencies	\$1,238,073
Administration	\$100
Interest	

Investment Operating Cost Summary						
NET OPERATING IMPACT (\$000's)	2020	2021	2022	2023	2024	2025
Operating Costs						
Debt & Finance Charges						
Total Direct Costs	-	-	-	-	-	-
Less: Incremental Revenue/Recovery	-	-	-	-	-	-
Net Cost/(Benefit)	-	-	-	-	-	-
Incremental Full Time Equivalent Positions						

Estimate Classification	Class 3
Assumptions	
Risks and Opportunities	
Reference Documents	

Document Control			
Major Changes from Previous Estimate			
Version #	Date	Author	Rationale



Basis of Estimate Capital Cost Detail

Investment Title	Fort Rogue Garage Hydrogen Infrastructure				
BC ID	0				
Estimate Date					May 20, 2021
In Service Year					2022
Class of Estimate					Class 3
Is this a Major Capital project?		No			

ESTIMATE DETAIL

		Cost Escalation / Capital Inflation	3%					3%					Total		
			Estimate Year		Year Project Work Undertaken										
			2021	2022	2023	2024	2025								
Construction/Equipment Costs															
	% of Const.	(\$000's)													
GC General Conditions	2%	\$150,000	\$154,500	\$0	\$0	\$0	\$0	\$0	\$0	\$0	\$0	\$0	\$154,500		
Site Works	2%	\$118,787	\$122,351	\$0	\$0	\$0	\$0	\$0	\$0	\$0	\$0	\$0	\$122,351		
Electrical Infrastructure	5%	\$374,515	\$385,751	\$0	\$0	\$0	\$0	\$0	\$0	\$0	\$0	\$0	\$385,751		
Structural	4%	\$285,000	\$293,550	\$0	\$0	\$0	\$0	\$0	\$0	\$0	\$0	\$0	\$293,550		
Hydrogen Equipment	86%	\$6,695,362	\$6,896,223	\$0	\$0	\$0	\$0	\$0	\$0	\$0	\$0	\$0	\$6,896,223		
Installation and Interconnections	3%	\$199,500	\$205,485	\$0	\$0	\$0	\$0	\$0	\$0	\$0	\$0	\$0	\$205,485		
Construction Costs Sub-total		100%	\$7,823,164	\$8,057,860	\$0	\$0	\$0	\$0	\$0	\$0	\$0	\$0	\$8,057,860		
Consultant Costs (Internal & External)															
	% of Const.	(\$000's)													
Engineering - site works, electrical, structural	2%	\$169,170	\$174,246	\$0	\$0	\$0	\$0	\$0	\$0	\$0	\$0	\$0	\$174,246		
	0%		\$0	\$0	\$0	\$0	\$0	\$0	\$0	\$0	\$0	\$0	\$0		
	0%		\$0	\$0	\$0	\$0	\$0	\$0	\$0	\$0	\$0	\$0	\$0		
	0%		\$0	\$0	\$0	\$0	\$0	\$0	\$0	\$0	\$0	\$0	\$0		
	0%		\$0	\$0	\$0	\$0	\$0	\$0	\$0	\$0	\$0	\$0	\$0		
Consultant Costs Sub-total		2%	\$169,170	\$174,246	\$0	\$0	\$0	\$0	\$0	\$0	\$0	\$0	\$174,246		
Construction & Consultant Sub-total			\$7,992,334	\$8,232,106	\$0	\$0	\$0	\$0	\$0	\$0	\$0	\$0	\$8,232,106		
Utility Costs															
	% C&C	(\$000's)													
Hydro	0%		\$0	\$0	\$0	\$0	\$0	\$0	\$0	\$0	\$0	\$0	\$0		
Communication - MTS	0%		\$0	\$0	\$0	\$0	\$0	\$0	\$0	\$0	\$0	\$0	\$0		
Communication - Shaw	0%		\$0	\$0	\$0	\$0	\$0	\$0	\$0	\$0	\$0	\$0	\$0		
	0%		\$0	\$0	\$0	\$0	\$0	\$0	\$0	\$0	\$0	\$0	\$0		
	0%		\$0	\$0	\$0	\$0	\$0	\$0	\$0	\$0	\$0	\$0	\$0		
Utility Costs Sub-total		0%	\$0	\$0	\$0	\$0	\$0	\$0	\$0	\$0	\$0	\$0	\$0		
Other Costs															
	% C&C	(\$000's)													
Land Acquisition	0%		\$0	\$0	\$0	\$0	\$0	\$0	\$0	\$0	\$0	\$0	\$0		
Insurance	0%		\$0	\$0	\$0	\$0	\$0	\$0	\$0	\$0	\$0	\$0	\$0		
ITS and Permits	0%	\$21,080	\$21,713	\$0	\$0	\$0	\$0	\$0	\$0	\$0	\$0	\$0	\$21,713		
	0%		\$0	\$0	\$0	\$0	\$0	\$0	\$0	\$0	\$0	\$0	\$0		
Other Costs Sub-total		0%	\$21,080	\$21,713	\$0	\$0	\$0	\$0	\$0	\$0	\$0	\$0	\$21,713		
Project Costs before Contingencies Sub-total			\$8,013,414	\$8,253,819	\$0	\$0	\$0	\$0	\$0	\$0	\$0	\$0	\$8,253,819		
Contingencies Costs															
	% Proj Cost	(\$000's)													
Contingency 15%	15%	\$1,202,012	\$1,238,073	\$0	\$0	\$0	\$0	\$0	\$0	\$0	\$0	\$0	\$1,238,073		
	0%		\$0	\$0	\$0	\$0	\$0	\$0	\$0	\$0	\$0	\$0	\$0		
	0%		\$0	\$0	\$0	\$0	\$0	\$0	\$0	\$0	\$0	\$0	\$0		
	0%		\$0	\$0	\$0	\$0	\$0	\$0	\$0	\$0	\$0	\$0	\$0		
	0%		\$0	\$0	\$0	\$0	\$0	\$0	\$0	\$0	\$0	\$0	\$0		
	0%		\$0	\$0	\$0	\$0	\$0	\$0	\$0	\$0	\$0	\$0	\$0		
Contingencies Costs Sub-total		15%	\$1,202,012	\$1,238,073	\$0	\$0	\$0	\$0	\$0	\$0	\$0	\$0	\$1,238,073		
Project Sub-total before Administrative Charges Subtotal			\$9,215,426	\$9,491,892	\$0	\$0	\$0	\$0	\$0	\$0	\$0	\$0	\$9,491,892		
% increase from base												103%			
Administrative Charges Detail															
Administrative Charges (* consult department Finance)															
			\$0	\$0	\$0	\$0	\$0	\$0	\$0	\$0	\$0	\$0	\$0		
	Departmental Staff	0.00%	\$0	\$0	\$0	\$0	\$0	\$0	\$0	\$0	\$0	\$0	\$0		
	Corporate Admin (max \$100,000)	1.25%	\$100	\$100	\$0	\$0	\$0	\$0	\$0	\$0	\$0	\$0	\$100		
	Municipal Accommodations charges (if delivering the project)	0.00%	\$0	\$0	\$0	\$0	\$0	\$0	\$0	\$0	\$0	\$0	\$0		
	Research (SMIR) (Construction Only, only applies to Public Works)	0.00%	\$0	\$0	\$0	\$0	\$0	\$0	\$0	\$0	\$0	\$0	\$0		
	Corporate Interest	0.00%	\$0	\$0	\$0	\$0	\$0	\$0	\$0	\$0	\$0	\$0	\$0		
			\$0	\$0	\$0	\$0	\$0	\$0	\$0	\$0	\$0	\$0	\$0		
			\$0	\$0	\$0	\$0	\$0	\$0	\$0	\$0	\$0	\$0	\$0		
			\$0	\$0	\$0	\$0	\$0	\$0	\$0	\$0	\$0	\$0	\$0		
			\$0	\$0	\$0	\$0	\$0	\$0	\$0	\$0	\$0	\$0	\$0		
			\$0	\$0	\$0	\$0	\$0	\$0	\$0	\$0	\$0	\$0	\$0		
			\$0	\$0	\$0	\$0	\$0	\$0	\$0	\$0	\$0	\$0	\$0		
			\$0	\$0	\$0	\$0	\$0	\$0	\$0	\$0	\$0	\$0	\$0		
Administrative Charges Sub-total		-	\$100	\$100	\$0	\$0	\$0	\$0	\$0	\$0	\$0	\$0	\$100		
Project Sub-total before Interest Charges Sub-total			\$9,215,526	\$9,491,992	\$0	\$0	\$0	\$0	\$0	\$0	\$0	\$0	\$9,491,992		
TOTAL CAPITAL PROJECT COST			\$9,215,526	\$9,491,992	\$0	\$0	\$0	\$0	\$0	\$0	\$0	\$0	\$9,491,992		



Basis of Estimate Summary

Investment Title	Fort Rogue Garage Hydrogen Infrastructure
Investment Description	
Department	
Date	21-Jun-21
BoE Author	Jessica Yablecki
BoE Estimating Team	Dillon Consulting
BoE Reviewed by	Sean Russell
Business Case ID	

Investment Capital Cost Summary	
CAPITAL COSTS (\$000's)	
Construction/Equipment	\$6,835,289
Consultant	\$174,246
Utility	
Other	\$21,713
Contingencies	\$1,054,687
Administration	\$100
Interest	

Investment Operating Cost Summary						
NET OPERATING IMPACT (\$000's)	2020	2021	2022	2023	2024	2025
Operating Costs						
Debt & Finance Charges						
Total Direct Costs	-	-	-	-	-	-
Less: Incremental Revenue/Recovery	-	-	-	-	-	-
Net Cost/(Benefit)	-	-	-	-	-	-
Incremental Full Time Equivalent Positions						

Estimate Classification	Class 3
Assumptions	
Risks and Opportunities	
Reference Documents	

Document Control			
Major Changes from Previous Estimate			
Version #	Date	Author	Rationale



Basis of Estimate Capital Cost Detail

Investment Title		Fort Rogue Garage Hydrogen Infrastructure							
BC ID		0							
							Estimate Date	June 21, 2021	
							In Service Year	2022	
							Class of Estimate	Class 3	
		Is this a Major Capital project?		No					
ESTIMATE DETAIL									
		Cost Escalation / Capital Inflation		3%	3%	3%	3%	3%	
		Estimate Year		Year Project Work Undertaken					
		2021		2022	2023	2024	2025	Total	
Construction/Equipment Costs		% of Const.	(\$000's)						
GC General Conditions	2%	\$150,000	\$154,500	\$0	\$0	\$0	\$0	\$154,500	
Site Works	2%	\$118,787	\$122,351	\$0	\$0	\$0	\$0	\$122,351	
Electrical Infrastructure	6%	\$374,515	\$385,751	\$0	\$0	\$0	\$0	\$385,751	
Structural	4%	\$285,000	\$293,550	\$0	\$0	\$0	\$0	\$293,550	
Hydrogen Equipment	83%	\$5,508,400	\$5,673,652	\$0	\$0	\$0	\$0	\$5,673,652	
Installation and Interconnections	3%	\$199,500	\$205,485	\$0	\$0	\$0	\$0	\$205,485	
Construction Costs Sub-total		100%	\$6,636,202	\$6,835,289	\$0	\$0	\$0	\$6,835,289	
Consultant Costs (Internal & External)									
		% of Const	(\$000's)						
Engineering - site works, electrical, structural	3%	\$169,170	\$174,246	\$0	\$0	\$0	\$0	\$174,246	
	0%		\$0	\$0	\$0	\$0	\$0	\$0	
	0%		\$0	\$0	\$0	\$0	\$0	\$0	
	0%		\$0	\$0	\$0	\$0	\$0	\$0	
	0%		\$0	\$0	\$0	\$0	\$0	\$0	
Consultant Costs Sub-total		3%	\$169,170	\$174,246	\$0	\$0	\$0	\$174,246	
Construction & Consultant Sub-total			\$6,805,372	\$7,009,535	\$0	\$0	\$0	\$7,009,535	
Utility Costs									
		% C&C	(\$000's)						
Hydro	0%		\$0	\$0	\$0	\$0	\$0	\$0	
Communication - MTS	0%		\$0	\$0	\$0	\$0	\$0	\$0	
Communication - Shaw	0%		\$0	\$0	\$0	\$0	\$0	\$0	
	0%		\$0	\$0	\$0	\$0	\$0	\$0	
	0%		\$0	\$0	\$0	\$0	\$0	\$0	
Utility Costs Sub-total		0%	\$0	\$0	\$0	\$0	\$0	\$0	
Other Costs									
		% C&C	(\$000's)						
Land Acquisition	0%		\$0	\$0	\$0	\$0	\$0	\$0	
Insurance	0%		\$0	\$0	\$0	\$0	\$0	\$0	
ITS and Permits	0%	\$21,080	\$21,713	\$0	\$0	\$0	\$0	\$21,713	
	0%		\$0	\$0	\$0	\$0	\$0	\$0	
Other Costs Sub-total		0%	\$21,080	\$21,713	\$0	\$0	\$0	\$21,713	
Project Costs before Contingencies Sub-total			\$6,826,452	\$7,031,248	\$0	\$0	\$0	\$7,031,248	
Contingencies Costs									
		% Proj Cost	(\$000's)						
Contingency 15%	15%	\$1,023,968	\$1,054,687	\$0	\$0	\$0	\$0	\$1,054,687	
	0%		\$0	\$0	\$0	\$0	\$0	\$0	
	0%		\$0	\$0	\$0	\$0	\$0	\$0	
	0%		\$0	\$0	\$0	\$0	\$0	\$0	
	0%		\$0	\$0	\$0	\$0	\$0	\$0	
	0%		\$0	\$0	\$0	\$0	\$0	\$0	
Contingencies Costs Sub-total		15%	\$1,023,968	\$1,054,687	\$0	\$0	\$0	\$1,054,687	
Project Sub-total before Administrative Charges Subtotal			\$7,850,420	\$8,085,935	\$0	\$0	\$0	\$8,085,935	
				% increase from base					103%
Administrative Charges Detail									
Administrative Charges (* consult department Finance)									
Departmental Staff	0.00%	\$0	\$0	\$0	\$0	\$0	\$0	\$0	
Corporate Admin (max \$100,000)	1.25%	\$100	\$100	\$0	\$0	\$0	\$0	\$100	
Municipal Accommodations charges (if delivering the project)	0.00%	\$0	\$0	\$0	\$0	\$0	\$0	\$0	
Research (SMIR) (Construction Only, only applies to Public Works)	0.00%	\$0	\$0	\$0	\$0	\$0	\$0	\$0	
Corporate Interest	0.00%	\$0	\$0	\$0	\$0	\$0	\$0	\$0	
		\$0	\$0	\$0	\$0	\$0	\$0	\$0	
		\$0	\$0	\$0	\$0	\$0	\$0	\$0	
		\$0	\$0	\$0	\$0	\$0	\$0	\$0	
		\$0	\$0	\$0	\$0	\$0	\$0	\$0	
		\$0	\$0	\$0	\$0	\$0	\$0	\$0	
		\$0	\$0	\$0	\$0	\$0	\$0	\$0	
		\$0	\$0	\$0	\$0	\$0	\$0	\$0	
Administrative Charges Sub-total		-	\$100	\$100	\$0	\$0	\$0	\$100	
Project Sub-total before Interest Charges Sub-total			\$7,850,520	\$8,086,035	\$0	\$0	\$0	\$8,086,035	
TOTAL CAPITAL PROJECT COST			\$7,850,520	\$8,086,035	\$0	\$0	\$0	\$8,086,035	

Appendix B

Drawings

21 May 2021

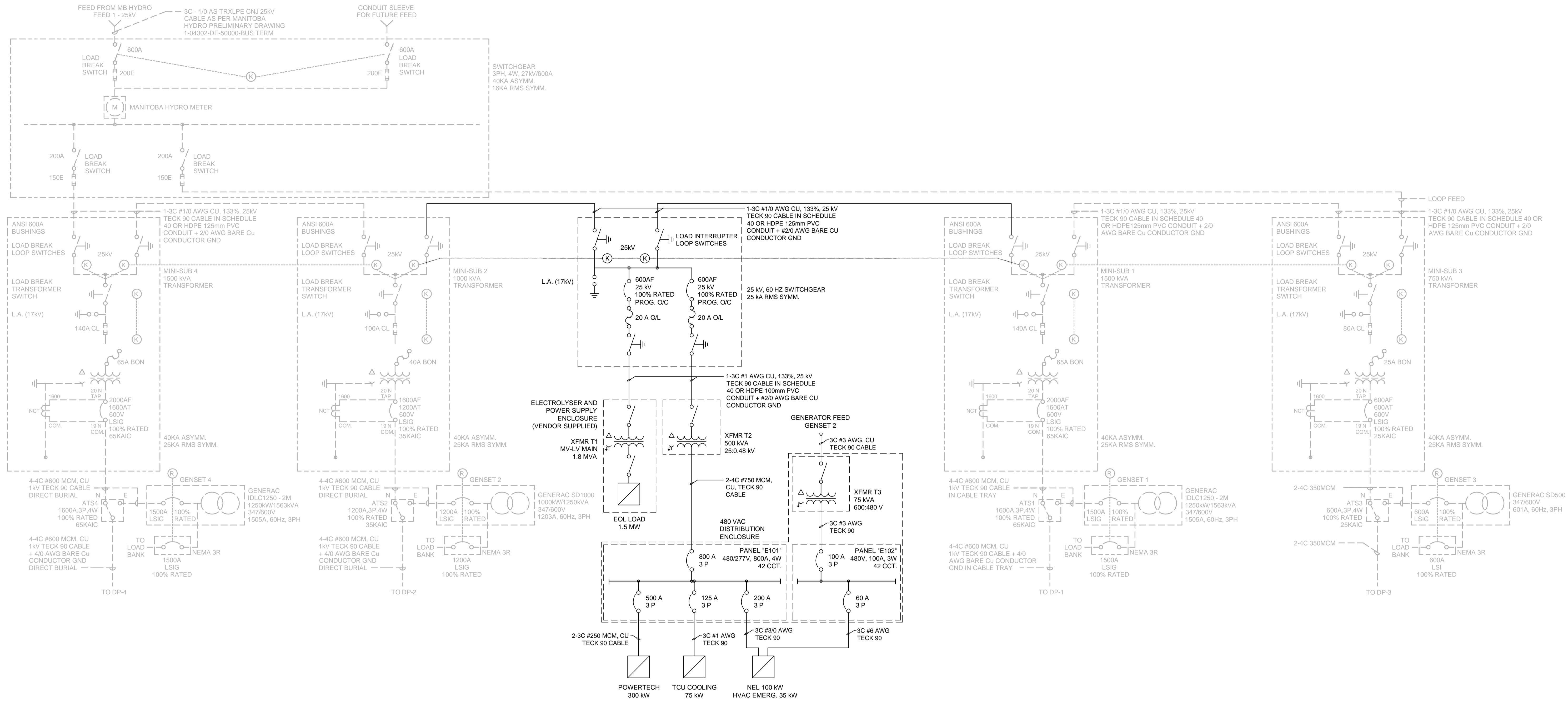

211393-04-ELEC-COIN.dwg

PRELIMINARY

NOT FOR CONSTRUCTION



DESIGNED BY	CAL	CHECKED BY	
DRAWN BY	CAL	APPROVED BY	
HOR. SCALE	NTS	RELEASED FOR CONSTRUCTION	
VERTICAL	N/A		
DATE	2021/06/21	DATE	

ENGINEER'S SEAL

CONSULTANT PROJECT NUMBER
21-1393

THE CITY OF WINNIPEG
WATER AND WASTE DEPARTMENT

Winnipeg

WINNIPEG TRANSIT HYDROGEN STUDY

CITY DRAWING NUMBER 03
SHEET 03 OF XX
CONSULTANT DRAWING NUMBER E-01

SITE 3 ELECTRICAL SINGLE LINE SCHEMATIC

21 June 2021

21.1393-07-MECH-CON-SITE-PLANS-NEW PHOTO.dwg

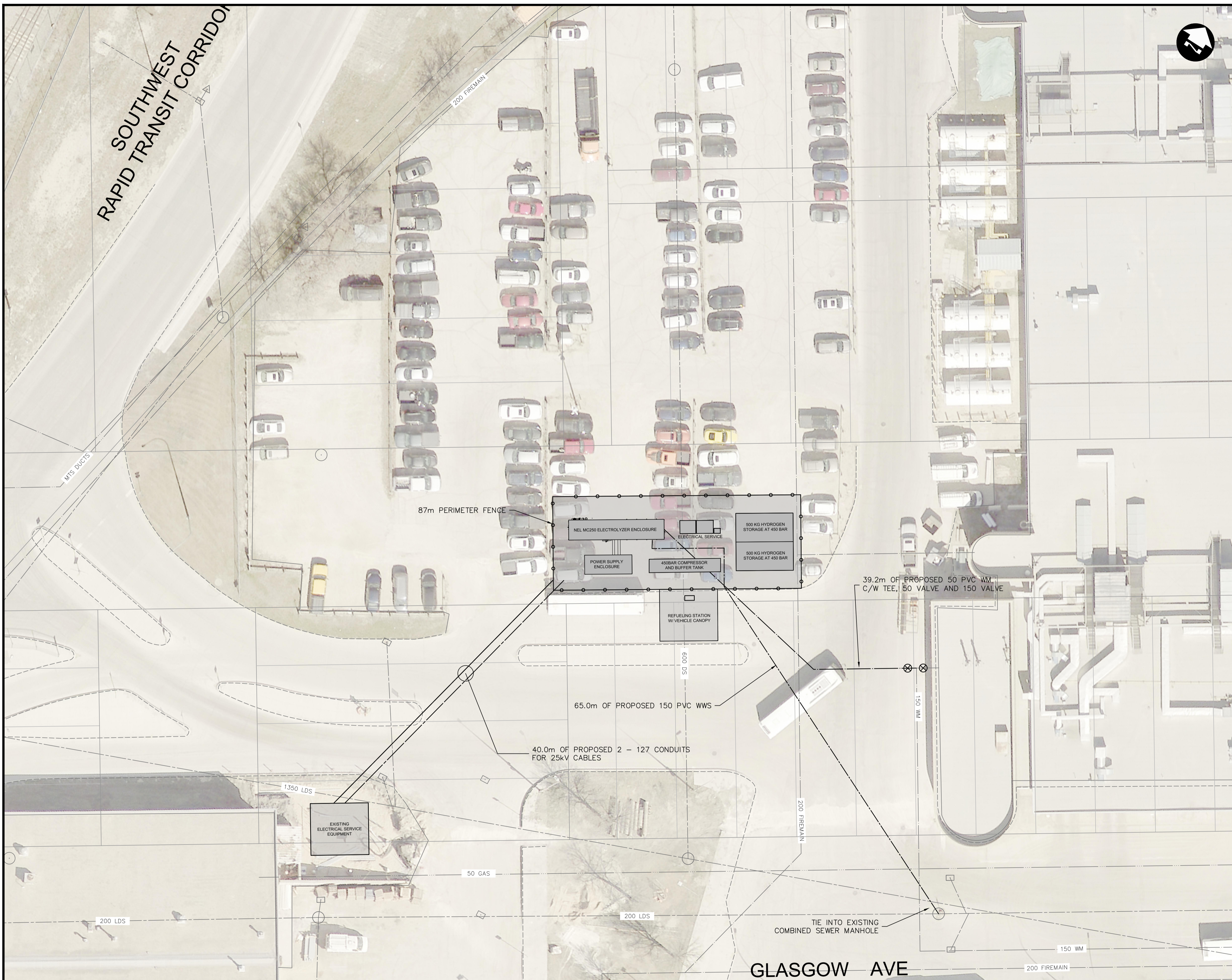

PRELIMINARY

NOT FOR CONSTRUCTION

APEGM
 Certificate of Authorization
 Dillon Consulting Limited (MB)
 No. 1789 Date: MAY.21.21

	HYDRANT			CONCRETE			WATERMAIN	
	VALVE			ASPHALT			LAND DRAINAGE SEWER	
	MANHOLE			SIDEWALK			WASTE WATER SEWER	
	CATCH BASIN			PAVING STONES			HYDRANT	
	CATCH PIT			PAVEMENT REPAIR FABRIC			VALVE	
	WATERMAIN			PROPERTY LINE			C PROFILE	
	LAND DRAINAGE SEWER			ELEVATION			NORTH/WEST GUTTER	
	WASTE WATER SEWER			TRAFFIC SIGNAL			SOUTH/EAST GUTTER	
	HYDRO			SURVEY BAR			NORTH/WEST DITCH	
	M.T.S.			CURB RAMP			SOUTH/EAST DITCH	
	GAS			DETECTABLE TILE			WWS FORCE MAIN	
	EXISTING			LEGEND-PLAN			LEGEND-PROFILE	

UNDERGROUND STRUCTURES SUPPLY U/G STRUCTURES DATE		 DESIGNED BY: DES DRAWN BY: WJK HOR. SCALE: 1:250 VERTICAL: N/A DATE: 2020/12/21	CHECKED BY: APPROVED BY: RELEASED FOR CONSTRUCTION DATE:
LOCATION OF UNDERGROUND STRUCTURES AS SHOWN ARE BASED ON THE BEST INFORMATION AVAILABLE BUT NO GUARANTEE IS GIVEN THAT ALL EXISTING UTILITIES ARE SHOWN OR THAT THE GIVEN LOCATIONS ARE EXACT. CONFIRMATION OF EXISTENCE AND EXACT LOCATION OF ALL SERVICES MUST BE OBTAINED FROM THE INDIVIDUAL UTILITIES BEFORE PROCEEDING WITH CONSTRUCTION.			
NO.	REVISIONS		

 THE CITY OF WINNIPEG WATER AND WASTE DEPARTMENT		CITY DRAWING NUMBER 03
WINNIPEG TRANSIT HYDROGEN STUDY		SHEET 03 OF XX
CONSULTANT PROJECT NUMBER 21-1393		CONSULTANT DRAWING NUMBER 01

File Name: c:\pw\working directory\projects\2021\40z\h\dms\14042\211393-07-mech-con.dwg

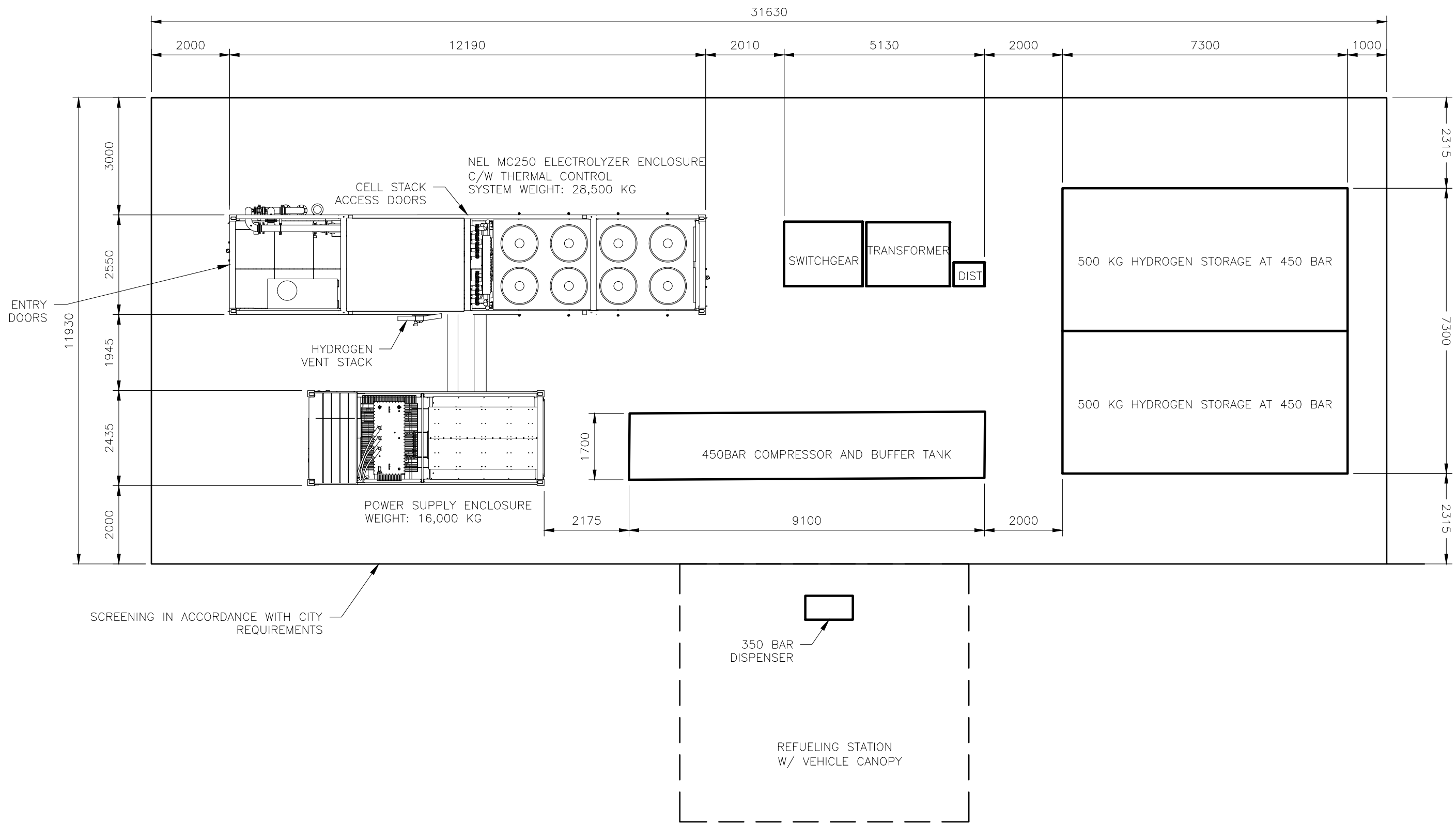

EQUIPMENT SKIDS
1:100

 DILLON CONSULTING	PROJECT WINNIPEG TRANSIT HYDROGEN STUDY	PROJECT NO. 21-1393
	DATE May 2021	TITLE EQUIPMENT LAYOUT

Appendix C

Equipment Specification Sheets



M Series Containerized Proton® PEM Hydrogen generation systems

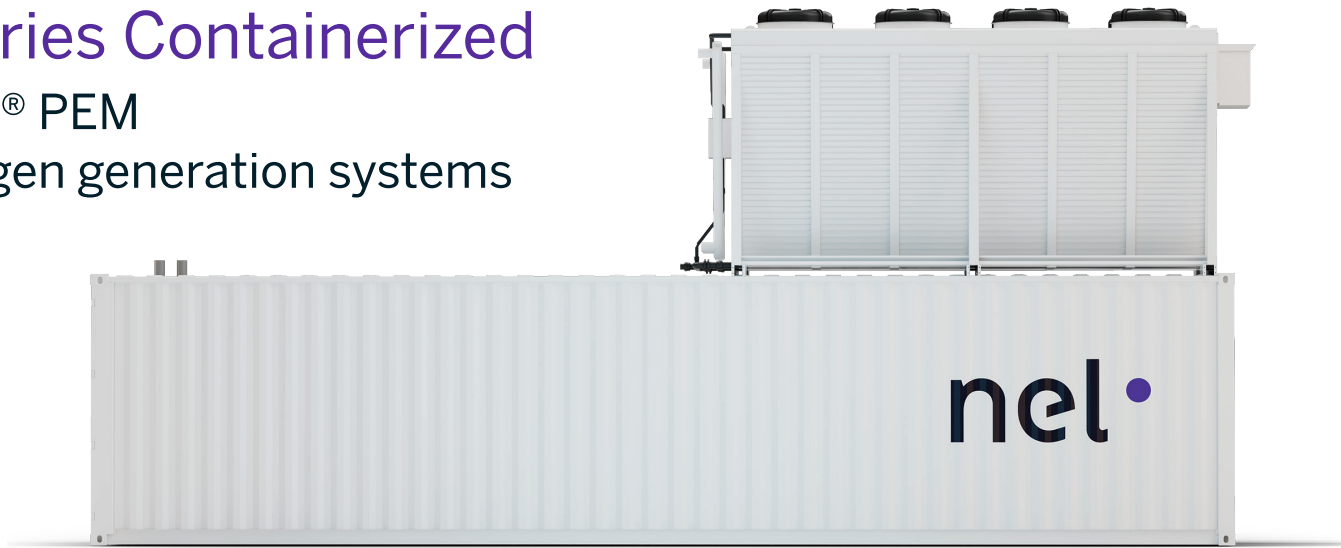

MODEL	MC250	MC500
Class	1.25 MW	2.5 MW
Description	Fully-automated MW-class on-site hydrogen generator utilizing a modular containerized design for ease of installation and integration Tri-mode operation (selectable): <ul style="list-style-type: none"> • Command-following mode allows operation based on available input power • Load following mode automatically adjusts output to match demand • Tank filling mode operates with power-conservation mode during standby 	
Electrolyte	Proton Exchange Membrane (PEM) – caustic-free	
HYDROGEN PRODUCTION		
Net production rate Nm ³ /h @ 0° C, 1 bar SCF/h @ 70° F, 1 atm kg/24 h	246 Nm ³ /h 9,352 SCF/h 531 kg/24 h	492 Nm ³ /h 18,704 SCF/h 1,062 kg/24 h
Delivery pressure – nominal	30 barg (435 psig); full differential pressure H ₂ over O ₂	
Average power consumption at stack per volume of H ₂ gas produced ¹	4.5 kWh/Nm ³	
Average power consumption at stack per mass of H ₂ gas produced ¹	50.4 kWh/kg	
Purity (concentration of impurities)	99.95% [H ₂ O < 500 ppm, N ₂ < 2 ppm, O ₂ < 1 ppm, all others undetectable]	
Purity (concentration of impurities with optional high purity dryer)	ISO 14687:2019(E) Type I, Type II Grade D and SAE J-2719 Type I Grade L 99.9995% [H ₂ O < 5 ppm, N ₂ < 2 ppm, O ₂ < 1 ppm, all others undetectable]	
Start-up time (from off state)	< 5 min	
Ramp-up time (minimum to full load)	< 15 sec	
Ramp rate (% of full-scale)	≥ 15% per sec (power input mode)	
Production capacity dynamic range	10 to 100%	
DI WATER REQUIREMENT		
Consumption rate at maximum production	222 l/h (58 gal/h)	444 l/h (116 gal/h)
Temperature	5 to 40°C (41 to 104°F)	
Input water quality	Required: ASTM Type II Deionized Water, < 1 μS/cm (> 1 MΩ-cm) Preferred: ASTM Type I Deionized Water, < 0.1 μS/cm (> 10 MΩ-cm)	
Water purification system (included)	Reverse Osmosis/Electronic DI (RO/EDI)	

MODEL	MC250	MC500
ELECTRICAL SPECIFICATIONS		
Electrical requirements	Typical installation: 6.6 to 35 kV, three phase 50 Hz/60 Hz Low voltage, three phase required for balance of plant and ancillary equipment	
Power quality	Total harmonic distortion: < 5%, power factor: > 0.9 nominal power, at normal power	
PHYSICAL CHARACTERISTICS		
Electrolyser container ² W x D x H	12.2 m x 2.5 m x 3 m (40 ft x 8 ft x 9.9 ft)	12.2 m x 2.5 m x 3 m (40 ft x 8 ft x 9.9 ft)
Rectifier/transformer container ² W x D x H	6.1 m x 2.5 m x 2.6 m (20 ft x 8 ft x 8.5 ft)	12.2 m x 2.5 m x 3 m (40 ft x 8 ft x 9.9 ft)
ENVIRONMENTAL CONSIDERATIONS – DO NOT FREEZE		
Standard siting location	Outdoor, pad mounted Flatness 35/25 per ACI-117-10 Bottom access for AC and DC electrical connections, water and drains	
Storage/transport temperature	5 to 60°C (41 to 140°F)	
Ambient temperature	-20 to 40°C (-4 to 104°F)	
Altitude range-sea level	1,000 m (3,281 ft)	
OPTIONS		
• Medium voltage input 4.16 to 6.6 kV	• Thermal control unit	• High purity hydrogen dryer with dew point meter

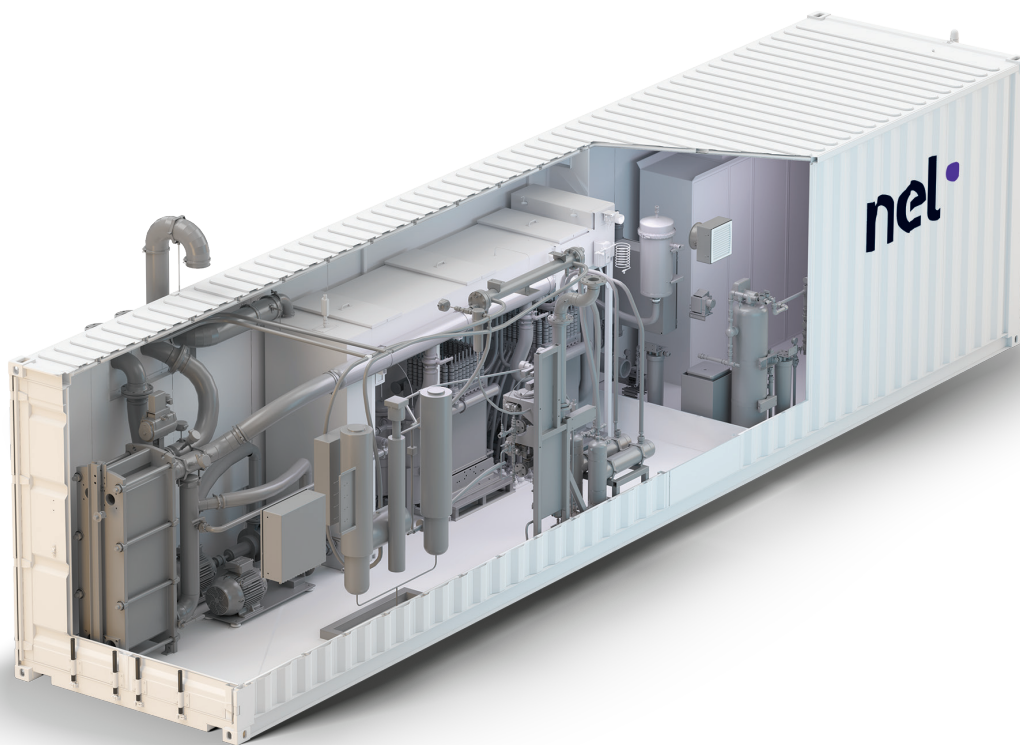

Representative views of MC500 – installation may vary.

Specifications are subject to change based on siting and configuration. Please contact Nel Hydrogen for solutions to best fit your needs.

¹ Dependent on configuration and operating conditions.

² Plus vent and rooftop equipment, site specific.

UTILITIES REQUIREMENTS: Nel PROTON® PEM M-SERIES CONTAINERIZED WATER ELECTROLYSER

				MC250 (246Nm ³ /h)	MC500 (492Nm ³ /h)
POTABLE FEED WATER (Potable water quality can effect usage)	INITIAL FILL	Initial Fill	Liters	2496	2496
		Minimum Flow Rate Required	Lpm	17.77	35.55
	STEADY USE DURING OPERATION	Specific Water Use	L/Nm ³ /hr	1.44	1.44
		10% Load - 1 hour average	Lpm	0.59	1.18
		100% Load - 1 hour average	Lpm	5.92	11.85
		At full flow	L/hr	355	711
		Water Temp. Range	C° (F°)	5 to 40 (41 to 104)	5 to 40 (41 to 104)
		Pressure	BarG (PsiG)	2 to 4 (30 to 60)	2 to 4 (30 to 60)
		RO-DI system Reject Drain (full load)	Lpm	3.6	7.1
PROCESS COOLING Nel Scope if TCU = Thermal Control Unit is selected	CELL STACKS - EOL (water cooling) (values for equipment sizing) (no HX bypass provided)	Cooling Load	kW	496	992
		Coolant Temperature	C°	50 / 40 / 30 /10	50 / 40 / 30 /10
		Coolant flow at temperature	Lpm	1308 / 409 / 264 / 154	2623 / 819 / 527 / 308
		Coolant Max DP at HX	BarD	> 1.0	> 1.0
	CELL STACKS - BOL (water cooling) (expected nominal values at 100%) (no HX bypass provided)	Cooling Load	kW	353	496
		Coolant Temperature	C°	50 / 40 / 30 /10	50 / 40 / 30 /10
		Coolant flow at temperature	Lpm	410 / 291 / 188 / 110	850 / 583 / 376 / 219
		Coolant Max DP at HX	BarD	> 1.0	> 1.0
	RECTIFIERS	Cooling Load	kW	Outside air cooled	Outside air cooled
	MV TRANSFORMER	Cooling Load	kW	Outside air cooled	Outside air cooled
Coolant Composition	Glycol mixture concentration	%	up to 50%	up to 50%	
Coolant Purity	Solid Particles / pH	Micron / pH	Max. 50 / 6-8	Max. 50 / 6-8	
INSTRUMENT AIR	STEADY STATE	Steady State	Nm ³ /h	< 6	< 6
		Min Storage Tank Volume	Liters	50	50
		Supply pressure range	BarG	6 to 9	6 to 9
		Max. Rate 1 Second Average	Nm ³ /h	78	78
NITROGEN	AFTER MAINTENANCE & COMPLETE SHUTDOWN ONLY	Approx. Consumption Per Purge Set	Nm ³	2 @ 10 barG/ 4 @ 18barG	2 @ 10 barG/ 4 @ 18barG
		Min. Pressure	BarG	10 / 18	10 / 18
		Quality	%	>99.98	>99.98
		Min. Qty Suggested On Site	Nm ³	18.6 (3x "K-bottles", 48L Water Volume, 145barg)	18.6 (3x "K-bottles", 48L Water Volume, 145barg)
ELECTRICAL POWER	TYPICAL INSTALLATION: Medium Voltage: 1x 6.6-30kV AC, 3 phase & Protective Earth, 50Hz/60Hz. Ancillary Power: 1x 400 VAC, 3 phase + Neutral & Protective Earth, 50Hz (+/- 10% from nominal voltage) or 1x 480 VAC, 3 phase + Neutral & Protective Earth, 60Hz (+/- 10% from nominal voltage). BACKUP POWER: 30 to 40 kVA to cover HVAC during blackout conditions for heating and cooling as required, LV feed same requirements as ancillary power Note: Detailed electrical Single Line Diagram load list to be provided during project phase.				

Nel can offer peripheral equipment as an option for some of the utilities mentioned above. Please refer to the quote.

Effluents

				MC250 (250Nm ³ /h)	MC500 (500Nm ³ /h)
WASTE WATER		Steady State	Lpm	4	7
		During Maintenance	Lpm	10 to 20	10-20
HYDROGEN VENT		Steady State	Lpm	15	30
		During Maintenance/Start/Stop	Lpm	4154	8308
OXYGEN VENT		Steady State	Lpm	2077	4154

Nel reserves the right to make changes at any time without notice, in materials, equipment, specifications and models shown in this document. These are not necessarily showing the equipment that will be installed in your system.

POTABLE & DI FEED WATER FOR PROTON® PEM WATER ELECTROLYSERS

Deionized (DI) water quality is critical for the lifetime of our Proton® PEM H₂ water electrolyzers. Water not meeting specifications will have irreversible impact on the system. If only potable or lower quality DI water is available, Nel will supply a DI water purification system. Nel strongly suggests and can make it compulsory to select that equipment to ensure proper operation and lifetime of the H₂ generator. Local tap water quality report will be required in order to evaluate if it is appropriate or requires our standard RO/DI (or adapted one) to accommodate with local water quality and ensure a proper feed to our water electrolyser.

CUSTOMER BUYING NEL'S RO/DI or RO/EDI (M-Series) WATER SYSTEM			
Source:	Potable Water. Usually 1.3-1.5 l (3.96-4.56 gal) of tap water will produce 1l of DI water (this ratio might vary depending on the supplied water quality)		
S-SERIES / H-SERIES / C10 (RO/DI)			
Fouling Index:	< 10 FI	Silica:	< 30 ppm SiO ₂
Conductivity:	< 2000 µS/cm	Temperature:	+1°C to +35°C (+34°F to +95°F)
Free Chlorine:	< 0.5 ppm Cl ₂	Feedwater pressure:	> 0.5 (7.5); < 2.0 (30) Bar (psi)
Heavy Metals:	< 0.05 ppm		
C20 / C30 (RO/DI)			
Fouling Index:	< 10 FI	Silica:	< 30 ppm SiO ₂
Conductivity:	< 1400 µS/cm	Hardness:	< 250 ppm CaCO ₃
Free Chlorine:	< 4 ppm Cl ₂	Chloramine:	< 1 ppm Cl ₂
Iron/Manganese:	< 0.1 ppm Fe/Mn	Temperature:	+4°C to +40°C (39°F to 104°F)
Organics:	< 3 ppm TOC	Feedwater pressure:	2 to 6 bar (29 to 87 psi)
M-SERIES (RO/EDI)			
Bicarbonate Alkalinity (HCO₃):	< 90 mg/l as CaCO ₃	Barium:	< 0.1 mg/l as Ba
Total Alkalinity (M):	< 150 mg/l as CaCO ₃	Chloride:	< 50 mg/l as Cl
Total Dissolved Solids (TDS):	< 350 mg/l	Copper:	< 0.5 mg/l as Cu
Total Organic Carbon (TOC):	< 5 mg/l as C	Iron:	< 0.3 mg/l as Fe
Silt Density Index (SDI)	< 5	Nitrate:	< 5 mg/l as NO ₃
Total Residual Chlorine (Cl₂):	< 1 mg/l	Sodium:	< 30 mg/l as Na
Total Hydrogen Sulfide (H₂S)	< 0.3 mg/l	Sulfate:	< 90 mg/l as SO ₄
Total Suspended Solids (TSS)	< 1 mg/l	Zinc:	< 0.1 mg/l as Zn
Feedwater pressure:	3.8 to 4.8 bar (55 to 70 psi)	Temperature:	+7°C to +32°C (45°F to 90°F)
		Calcium (Ca):	< 120 mg/l as CaCO ₃
		Magnesium (Mg):	< 50 mg/l as CaCO ₃
		Total Silica:	< 30 mg/l as SiO ₂
		Manganese:	< 0.1 mg/l as Mn
		Total Hardness:	< 150 mg/l as CaCO ₃
		Turbidity:	1 NTU
		pH:	6.5 - 9.0

CUSTOMER NOT BUYING NEL'S RO/DI or RO/EDI (M-Series) WATER SYSTEM			
Water Quality*:	ASTM Type II required (<1µS/cm; >1MΩ-cm) ASTM Type I recommended (<0.1µS/cm; >10MΩ-cm)		
Max. Water T°:	S-Series: +5°C to 35°C (41°F to 95°F)	H-series: +5°C to 50°C (41°F to 122°F)	C & M-Series: +5°C to 40°C (41°F to 104°F)
Pressure:	S & H-Series: 1.5 to 4 bar (21.8 to 58 psi)		C & M-Series: 1.0 to 4.1 bar (10 to 60 psi)
DI Water Requirement:	0.9 L/Nm ³ (0.24 gal/Nm ³)		

*: The only appropriate standard to be used for PEM water electrolysis is ASTM D1193 - 06(2011) Type 1 and 2. Some might refer to ISO 3696 but this standard is unfortunately not as stringent. Although it might be well suited for some applications, it does not provide the same level of definitions to ensure the right water quality for our system.

Tubing to be used: Polypropylene plastic tubing is highly recommended for the DI water feed line. FEP and PFA plastics are also acceptable. The only recommended metal line is clean, passivated 316SS. DO NOT USE: copper, aluminum, iron or other metal for de-ionized water inlet tubing as this will result in significant contamination and performance loss over time. PVC plastics are not acceptable, as they will damage the electrolyzer cell stacks.

Regulatory Body DI Water Standards: ASTM (American Society for Testing and Materials)

	Resistivity (MΩ-cm)	Conductivity (µS/cm)	pH at 25°C	Total Organic Carbon (TOC) ppb or µg/L	Sodium (ppb or µg/L)	Chloride (ppb or µg/L)	Silica (ppb or µg/L)
Type I	> 18	< 0.056	N/A	< 50	< 1	< 1	< 3
Type II	> 1	< 1	N/A	< 50	< 5	< 5	< 3

Nel reserves the right to make changes at any time without notice, in materials, specifications, and models shown in this document. These are not necessarily showing the equipment that will be installed in your system.

M Series Process Flow Diagram

PD-0600-0137

CRP Number	Rev	Date
011706	A	04/08/2020
011741	B	04/22/2020

- Indicates Supplier scope
- Equipment is certified by NRTL
- Indicates Purchaser Scope
- Indicates Optional Scope
- Process Gas
- Vented Gas
- Instrument Air
- Coolant
- Water
- AC Power
- Cell Stack Power
- Purchaser Scope
- Controls Information
- AC Rectifier Power

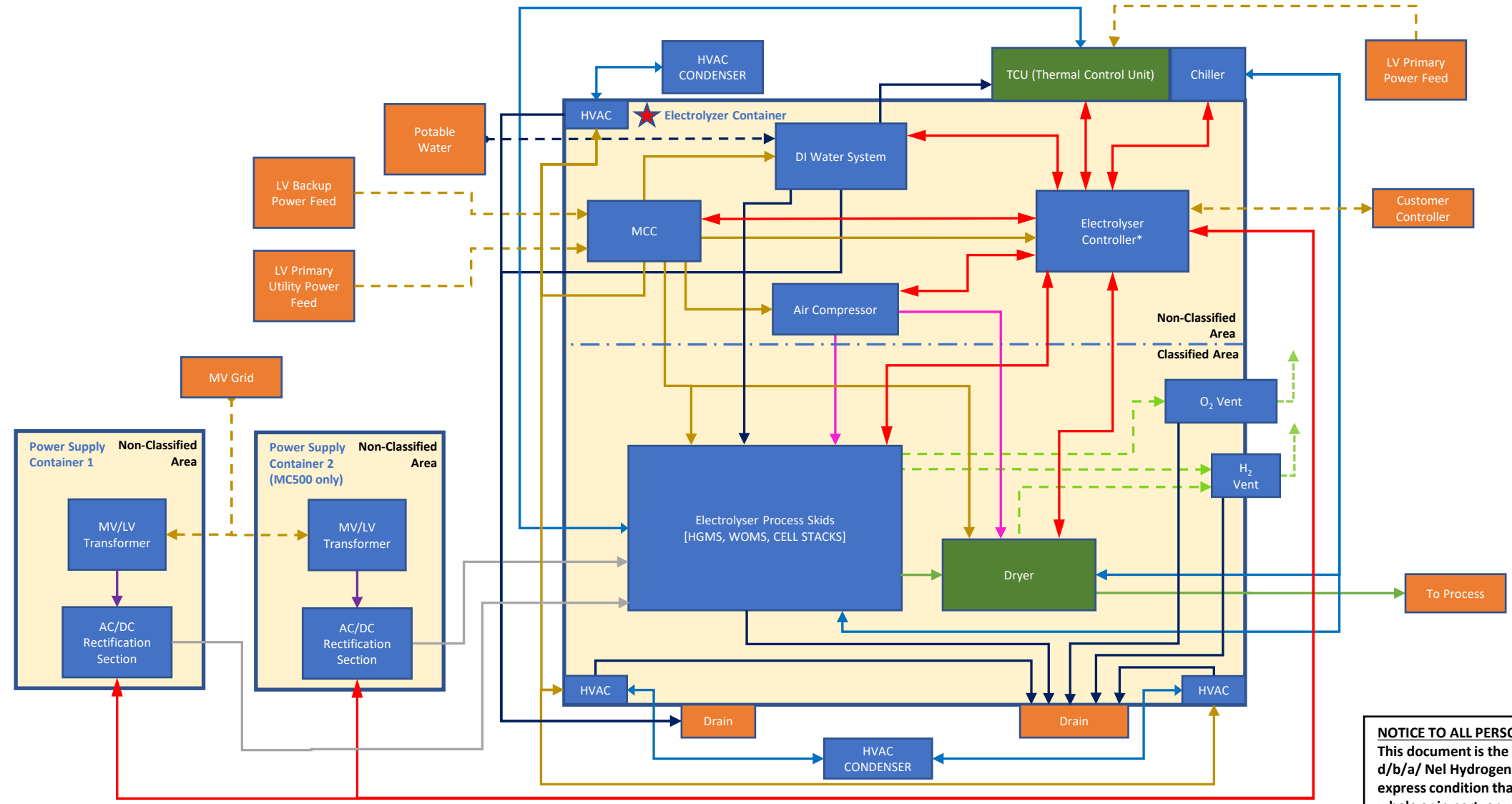

*Controller interfaces with MCC, AC/DC Rectification Section, TCU, Air Compressor, DI Water System, Dryer, Chiller, and Electrolyzer Process skids as applicable
 Note: This diagram is not intended to represent exact orientation or scale.

NOTICE TO ALL PERSONS RECEIVING THIS DOCUMENT:
 This document is the property of Proton Energy Systems, Inc. d/b/a/ Nel Hydrogen US (Nel) and is delivered on the express condition that it is not to be disclosed, reproduced in whole or in part, or used for manufacture for anyone other than Nel without its written consent, and that no right is granted to disclose or so use any information contained in said document. This restriction does not limit the right to use information obtained from another source.

- NOTES:
 1. ALL DIMENSIONS ARE IN DUAL DIMENSION FORMAT (MILLIMETER / INCHES). DIMENSIONS ARE REFERENCE ONLY.
 2. THE CONFIGURATION AND LAYOUT ARE PRELIMINARY AND SUBJECT TO CHANGE
 3. THE THERMAL CONTROL SYSTEM MAY VARY IN SIZE AND CONFIGURATION DEPENDING ON CUSTOMER REQUIREMENTS AND AMBIENT TEMPERATURE REQUIREMENTS.

DRW REV	DATE	ECR NO.	REVISIONS	INITIAL
2	06/11/2020	-	FOR QUOTATION PURPOSES ONLY	SS

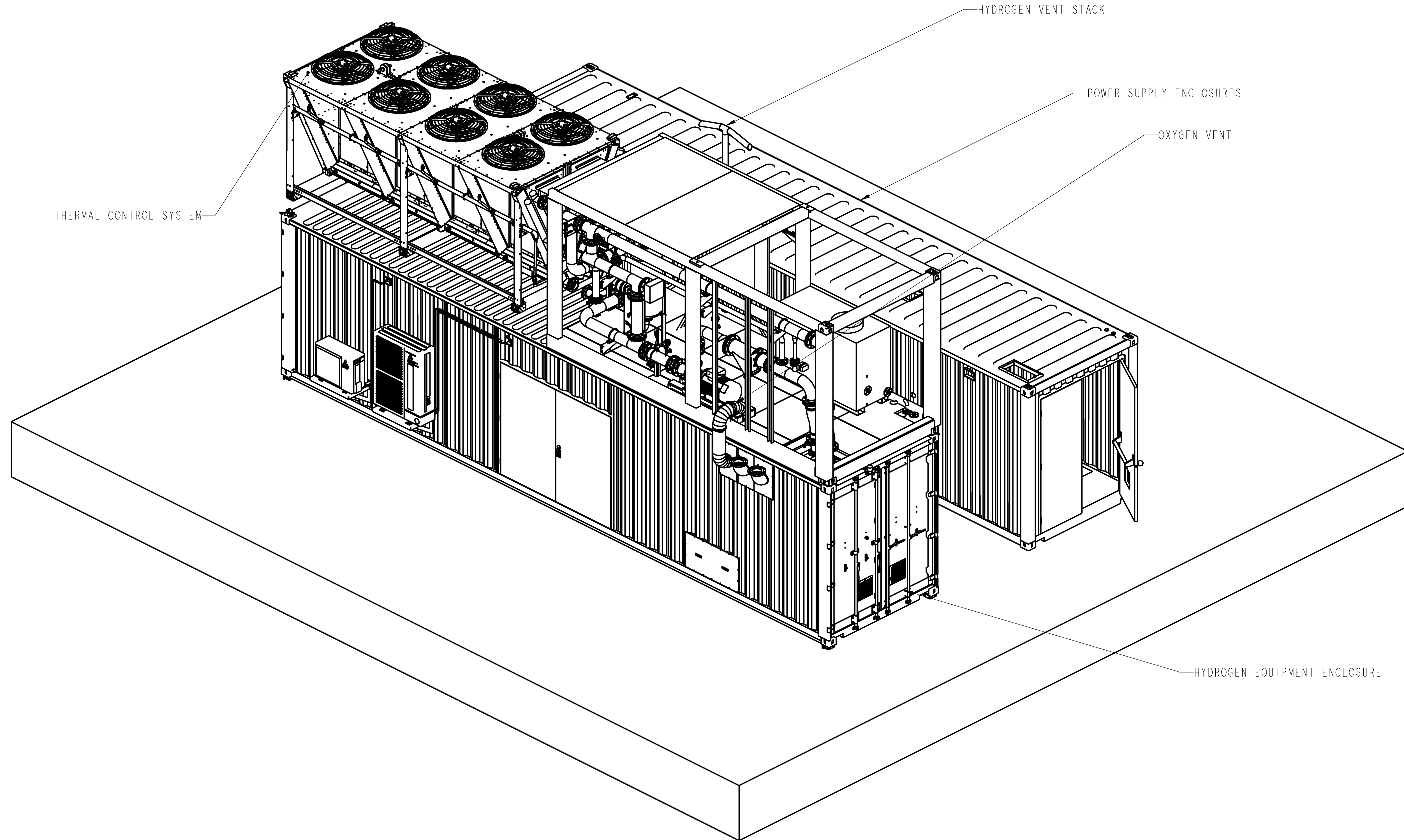

NOTICE TO ALL PERSONS RECEIVING THIS DRAWING:

This document is the property of Proton Energy Systems, Inc. d/b/a/ Nel Hydrogen US (Nel) and is delivered on the express condition that it is not to be disclosed, reproduced in whole or in part, or used for manufacture for anyone other than Nel without its written consent, and that no right is granted to disclose or so use any information contained in said document. This restriction does not limit the right to use information obtained from another source.

ISOMETRIC VIEW

UNLESS OTHERWISE SPECIFIED, ALL DIMS ARE DUAL DIMENSIONS MM [INCH]

LINEAR DIMENSIONS 100 AND UNDER TO BE WITHIN +/-1.0mm
 LINEAR DIMENSIONS OVER 100 AND UNDER 500 TO BE WITHIN +/-2.0mm
 LINEAR DIMENSIONS OVER 500 TO BE WITHIN +/-3.0mm
 ANGULAR TOLERANCES TO BE WITHIN +/-1 DEGREE

OVAL SYMBOL AROUND DIMENSION DENOTES QA INSPECTION

EXTRA DESC:

MTRL: FIN:

SPEC:

nel

APPROVALS:	GENERAL ARRANGEMENT, MC500, COOLING SYSTEM ON GROUND		
DRW: S.SALEH	SIZE	GA-1000-0016	REV
DSN:	D		2
ENG:	SCALE: 0.030	DO NOT SCALE DRAWING	VERSION:
MFG:	RELEASE LEVEL:		SHEET 1 OF 3
SYS:			

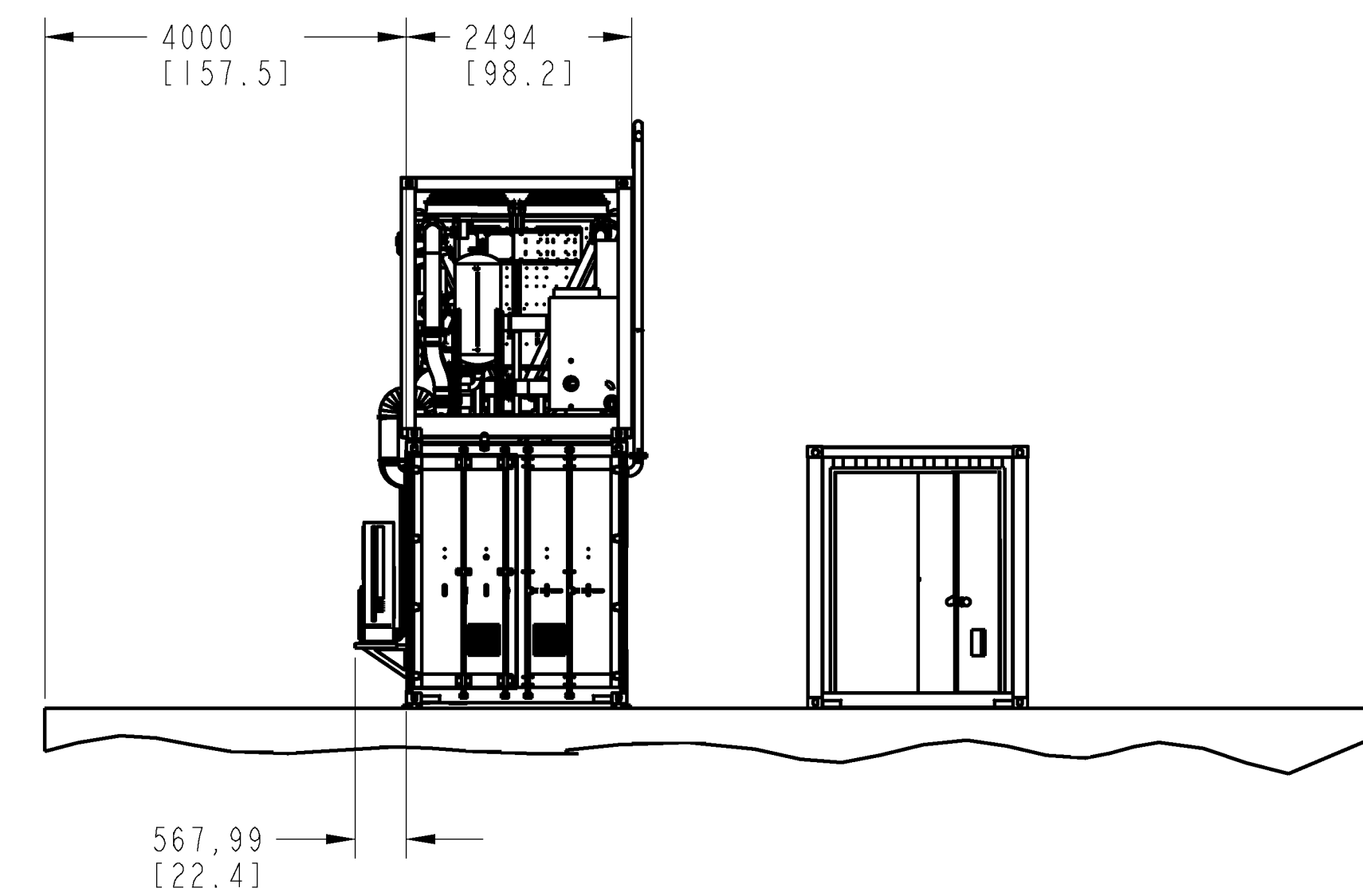
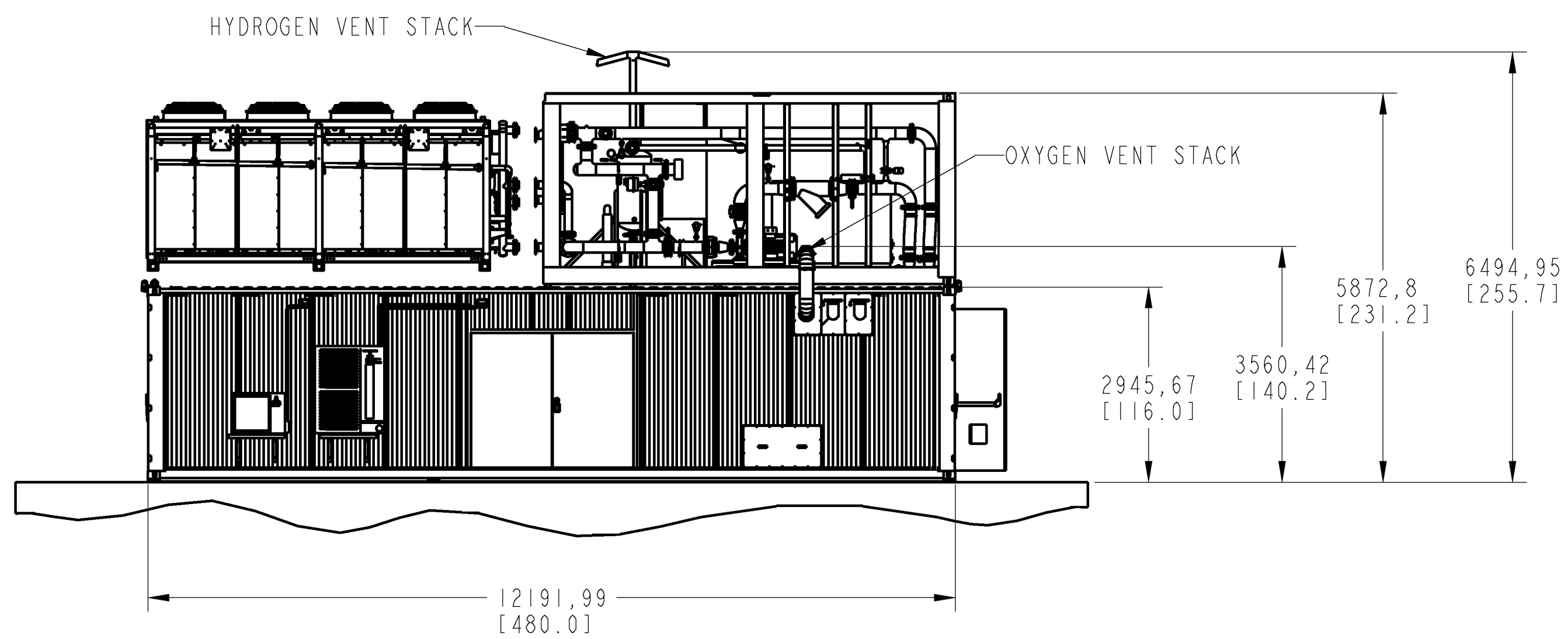
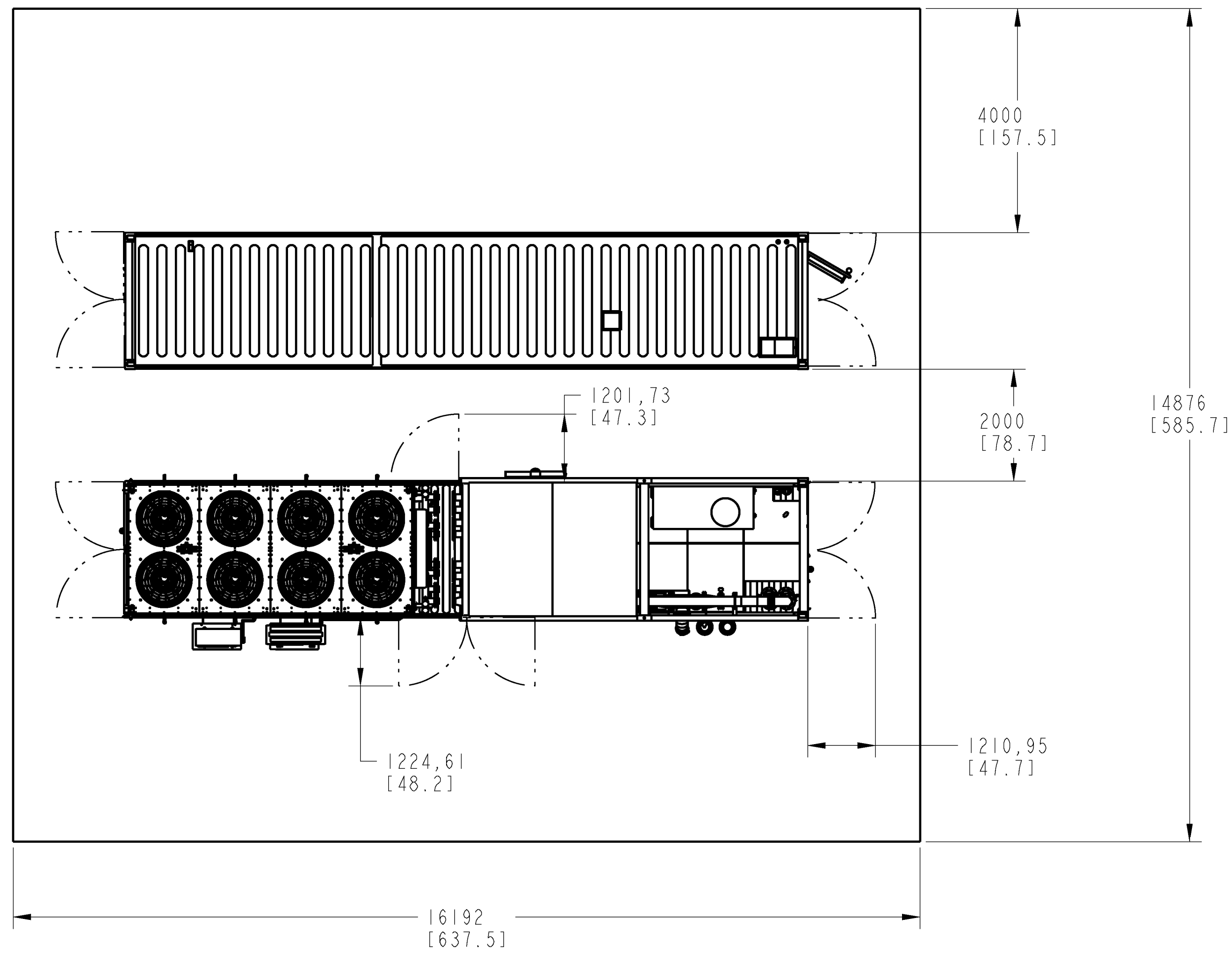

NOTICE TO ALL PERSONS RECEIVING THIS DRAWING:

This document is the property of Proton Energy Systems, Inc. d/b/a Nel Hydrogen US (Nel) and is delivered on the express condition that it is not to be disclosed, reproduced in whole or in part, or used for manufacture for anyone other than Nel without its written consent, and that no right is granted to disclose or so use any information contained in said document. This restriction does not limit the right to use information obtained from another source.

nel		
GENERAL ARRANGEMENT, MC500, COOLING SYSTEM ON GROUND		
SIZE D	GA-1000-0016	REV 2
SCALE: 0.015	DO NOT SCALE DRAWING	VERSION: 2
RELEASE LEVEL: Design		SHEET 2 OF 3

8

7

6

5

4

3

1

D

D

C

C

B

B

A

A

16192 REF
[637.5]

SERVICE AREA

SERVICE AREA

SERVICE AREA

14876 REF
[585.7]

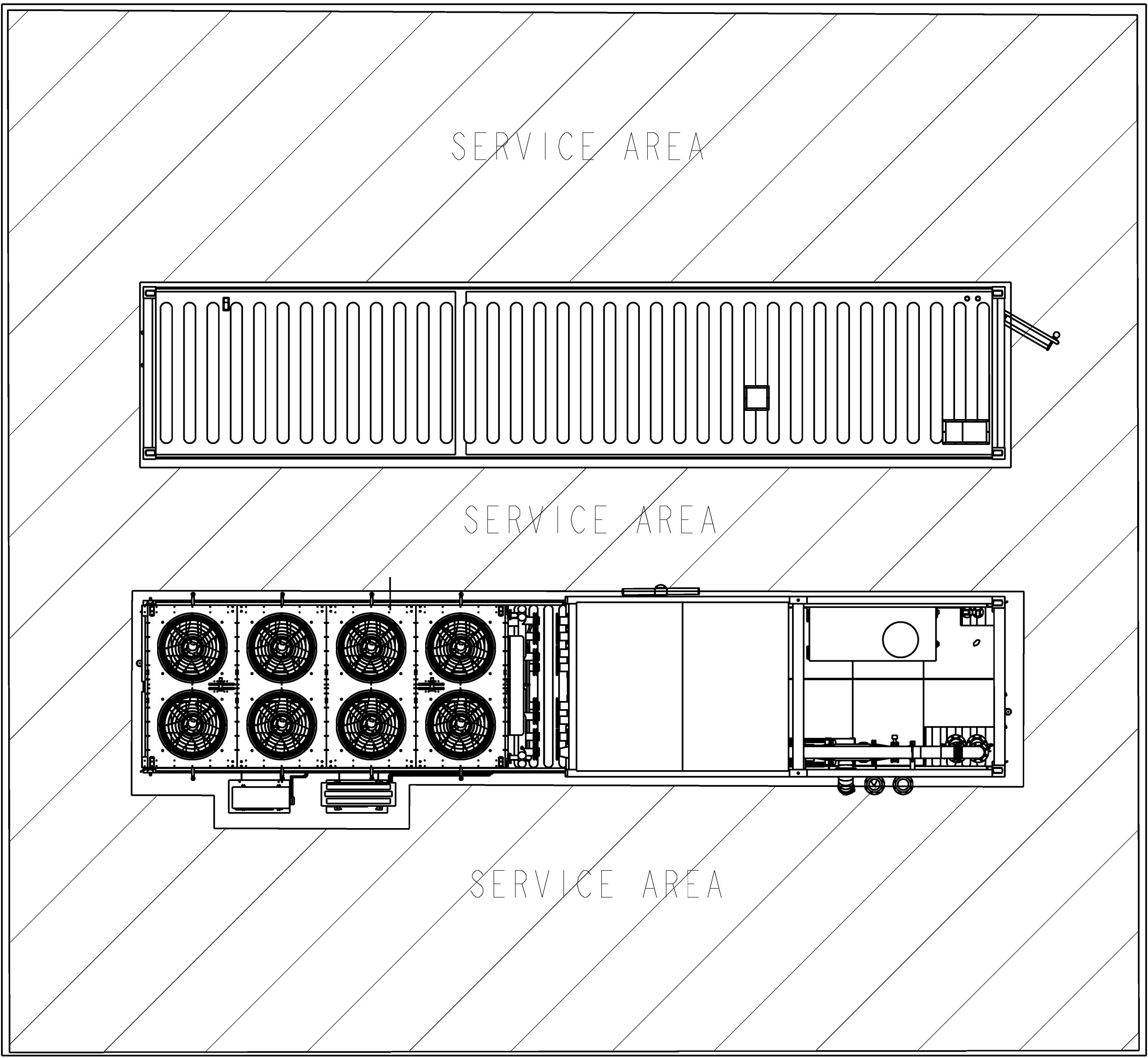

NOTICE TO ALL PERSONS RECEIVING THIS DRAWING:

This document is the property of Proton Energy Systems, Inc. d/b/a/ Nel Hydrogen US (Nel) and is delivered on the express condition that it is not to be disclosed, reproduced in whole or in part, or used for manufacture for anyone other than Nel without its written consent, and that no right is granted to disclose or so use any information contained in said document. This restriction does not limit the right to use information obtained from another source.

nel

GENERAL ARRANGEMENT, MC500, COOLING SYSTEM ON GROUND

SIZE D	GA-1000-0016	REV 2
SCALE: 0.060	DO NOT SCALE DRAWING	VERSION: 2
RELEASE LEVEL: Design		SHEET 3 OF 3

8

7

6

5

4

3

2

1

M Series MC500 System Efficiency

Nov 2020

M Series Projected Efficiency* as a Function of Hydrogen Output

Based on MC500: system efficiency includes process equipment, trans/rectifiers, and high purity dryer; excludes air comp, water treatment and process cooling

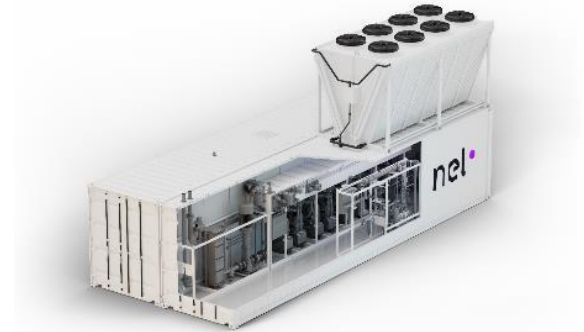
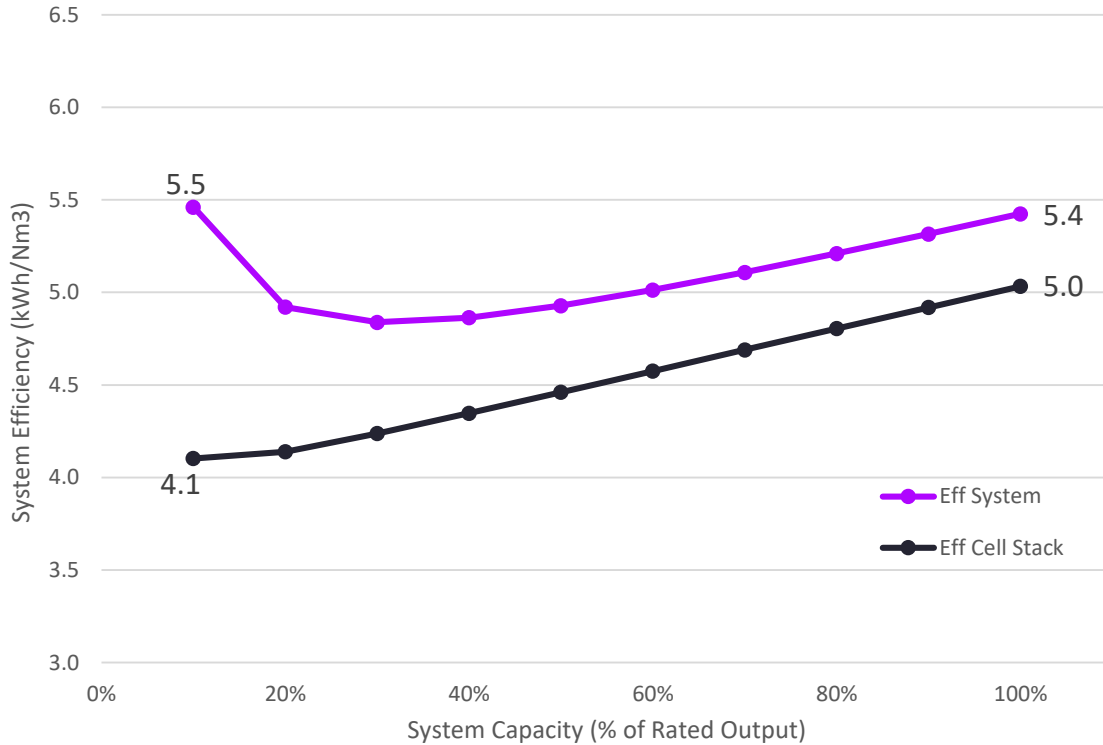

M Series MC500 Projected Efficiency as a Function of Hydrogen Output

Comparison between Beginning of Life (BOL) and Expected End of Life (EOL), excluding cooling

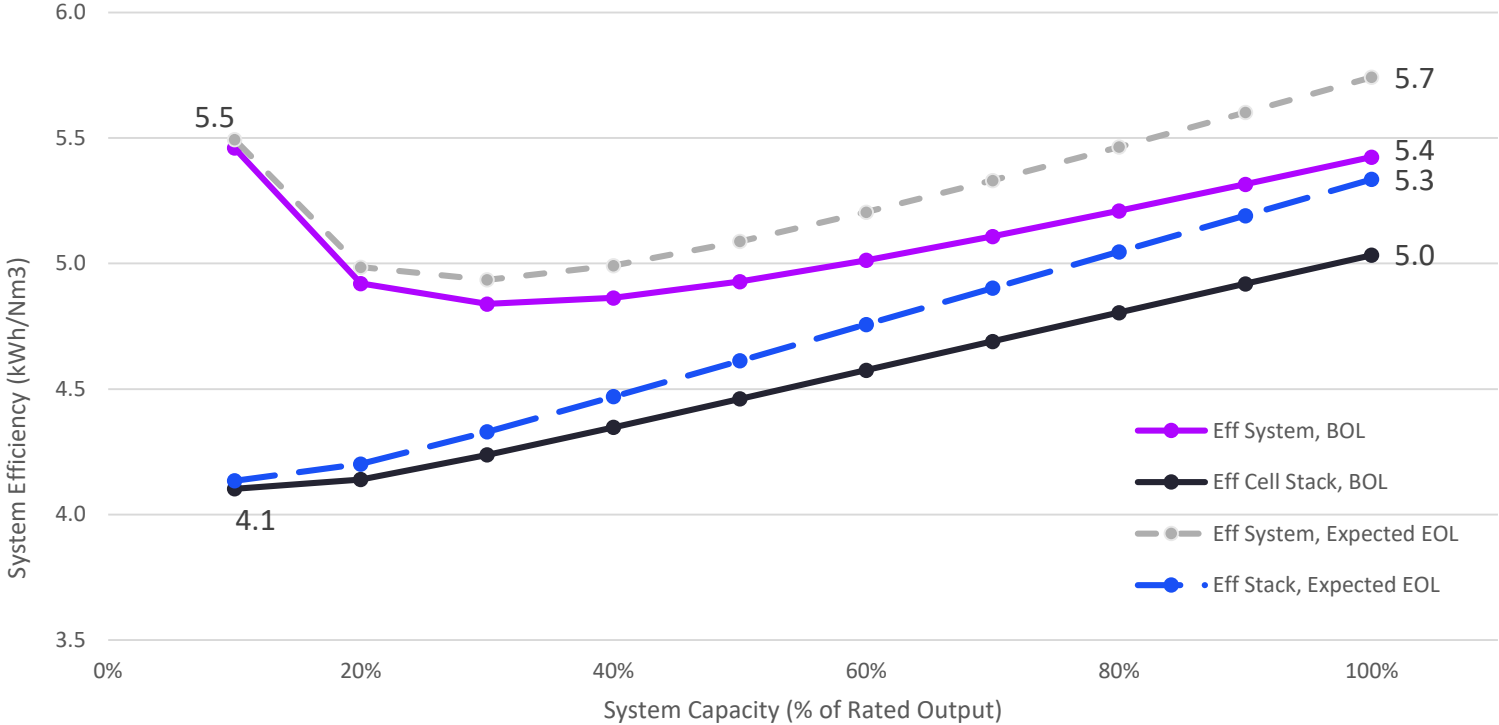

M Series Projected Efficiency* as a Function of Hydrogen Output

Based on MC500: system efficiency includes process equipment, trans/rectifiers, and high purity dryer; excludes air comp, water treatment and process cooling

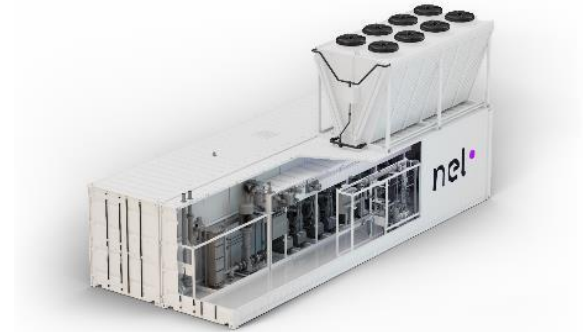
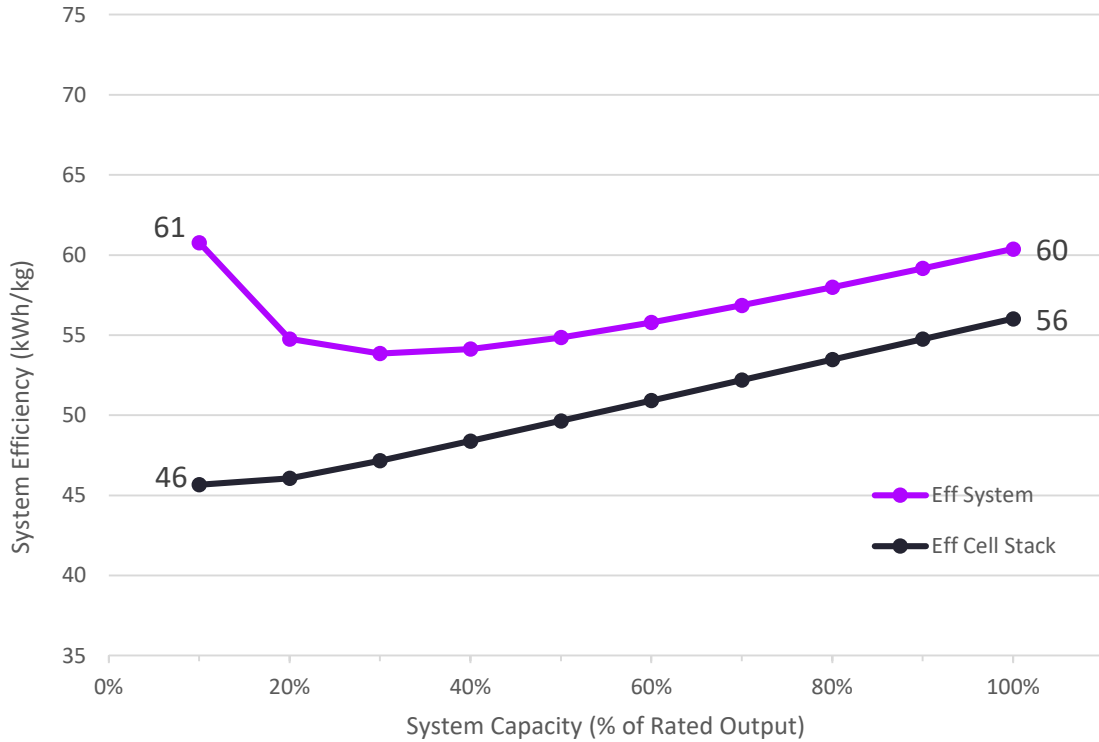

M Series MC500 Projected Efficiency as a Function of Hydrogen Output

Comparison between Beginning of Life (BOL) and Expected End of Life (EOL), excluding cooling

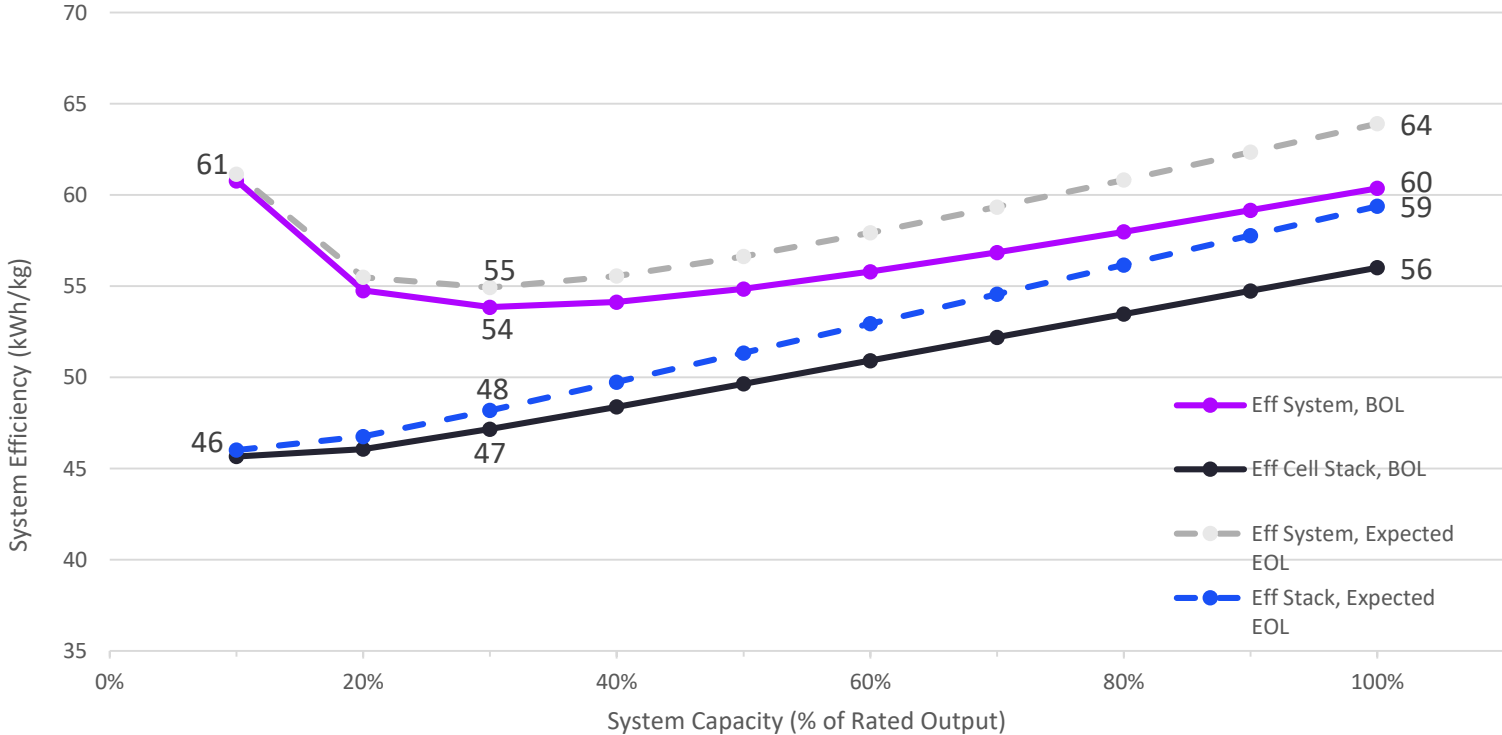

REV	DATE	ECR NUM.	REVISIONS	INITIAL
1	10/23/2019		Initial Draft	AAM
2	2/5/2020	011624	Initial Release	AAM
3	5/5/2020	011758	Update Drawing and Loads	AWB
4	5/29/2020	DRAFT	Added 480VAC to Page 2, Moved Air Comp to Single Phase	AWB

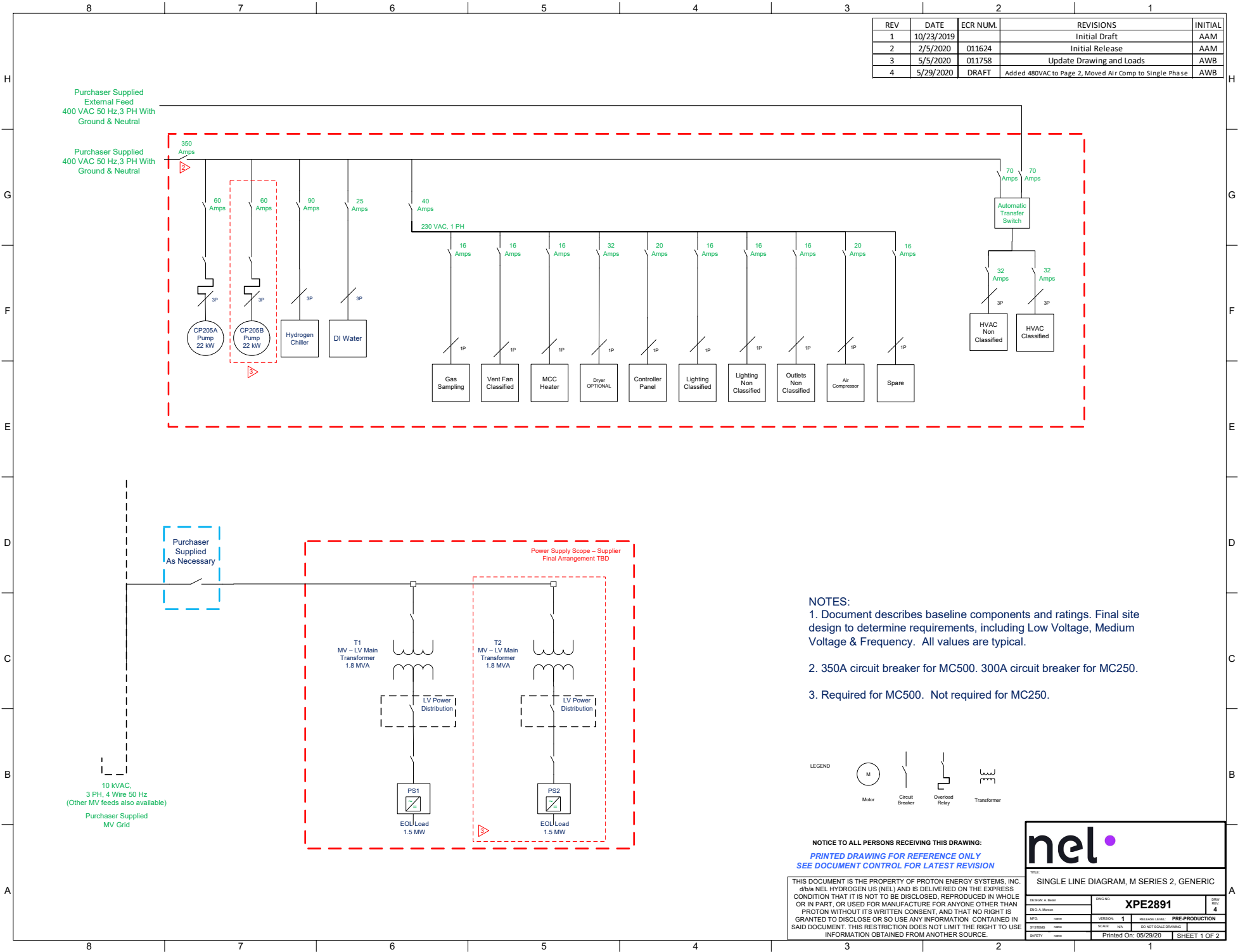

- NOTES:**
- Document describes baseline components and ratings. Final site design to determine requirements, including Low Voltage, Medium Voltage & Frequency. All values are typical.
 - 350A circuit breaker for MC500. 300A circuit breaker for MC250.
 - Required for MC500. Not required for MC250.

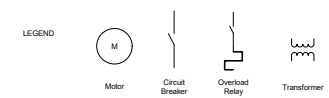

NOTICE TO ALL PERSONS RECEIVING THIS DRAWING:
 PRINTED DRAWING FOR REFERENCE ONLY
 SEE DOCUMENT CONTROL FOR LATEST REVISION

THIS DOCUMENT IS THE PROPERTY OF PROTON ENERGY SYSTEMS, INC. d/b/a NEL HYDROGEN US (NEL) AND IS DELIVERED ON THE EXPRESS CONDITION THAT IT IS NOT TO BE DISCLOSED, REPRODUCED IN WHOLE OR IN PART, OR USED FOR MANUFACTURE FOR ANYONE OTHER THAN PROTON WITHOUT ITS WRITTEN CONSENT, AND THAT NO RIGHT IS GRANTED TO DISCLOSE OR SO USE ANY INFORMATION CONTAINED IN SAID DOCUMENT. THIS RESTRICTION DOES NOT LIMIT THE RIGHT TO USE INFORMATION OBTAINED FROM ANOTHER SOURCE.			
SINGLE LINE DIAGRAM, M SERIES 2, GENERIC		Dwg No. XPE2891	
DESIGN A. Besser	SCALE: 1/8" = 1'	VERSION: 1	RELEASE LEVEL: PRE-PRODUCTION
DATE: 05/29/20	SCALE: 1/8" = 1'	SCALE: 1/8" = 1'	DO NOT SCALE DRAWING
SAFETY: none	Printed On: 05/29/20	SHEET 1 OF 2	

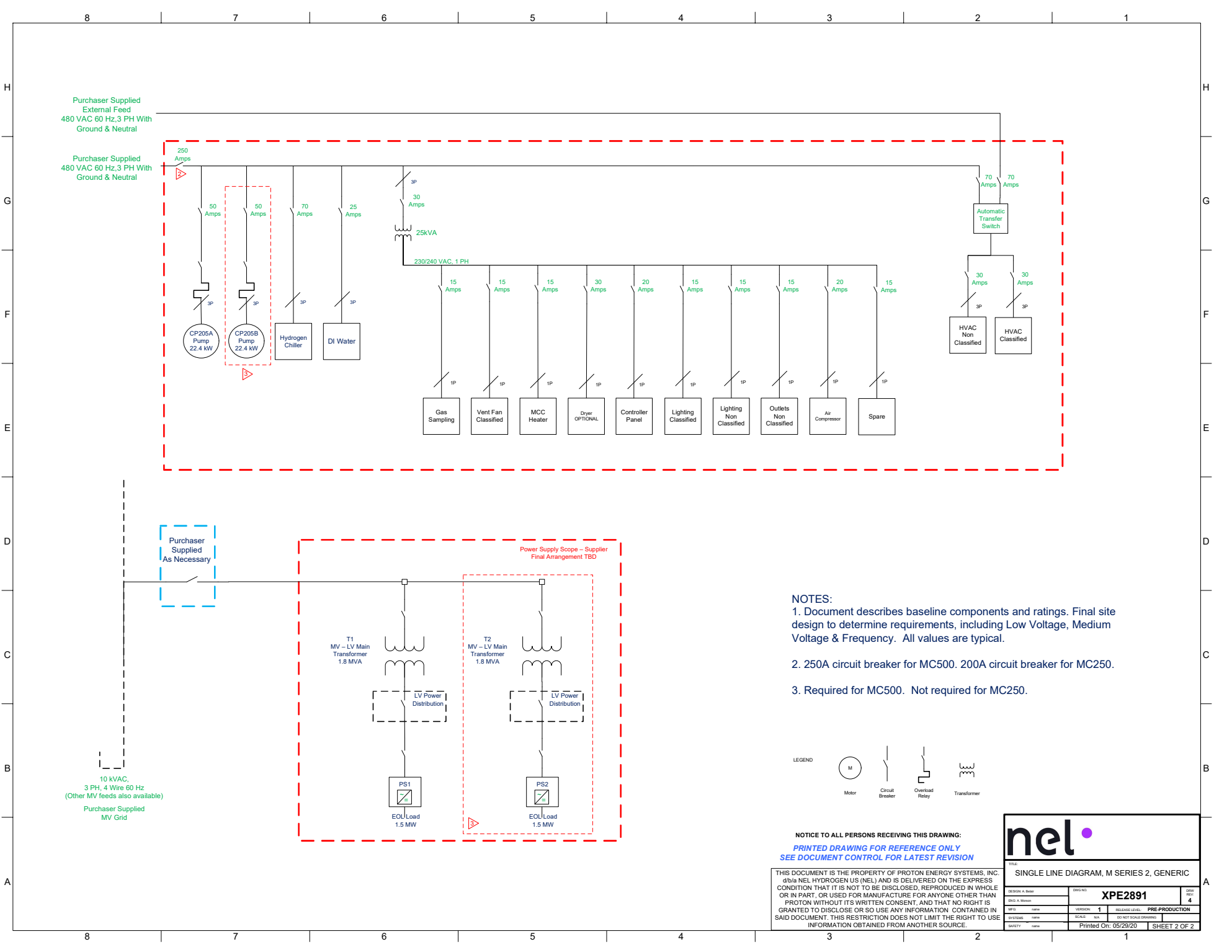

nel

DESIGN A: Base

DESIGN NO: **XPE2891**

REV: 4

VERSION: 1

RELEASE LEVEL: **PRE-PRODUCTION**

SCALE: 1/8" = 1'

DATE: 05/29/20

PRINTED ON: 05/29/20

SHEET 2 OF 2

THIS DOCUMENT IS THE PROPERTY OF PROTON ENERGY SYSTEMS, INC. d/b/a NEL HYDROGEN US (NEL) AND IS DELIVERED ON THE EXPRESS CONDITION THAT IT IS NOT TO BE DISCLOSED, REPRODUCED IN WHOLE OR IN PART, OR USED FOR MANUFACTURE FOR ANYONE OTHER THAN PROTON WITHOUT ITS WRITTEN CONSENT, AND THAT NO RIGHT IS GRANTED TO DISCLOSE OR SO USE ANY INFORMATION CONTAINED IN SAID DOCUMENT. THIS RESTRICTION DOES NOT LIMIT THE RIGHT TO USE INFORMATION OBTAINED FROM ANOTHER SOURCE.

Purchaser Supplied
External Feed
480 VAC 60 Hz 3 PH With
Ground & Neutral

Purchaser Supplied
480 VAC 60 Hz 3 PH With
Ground & Neutral

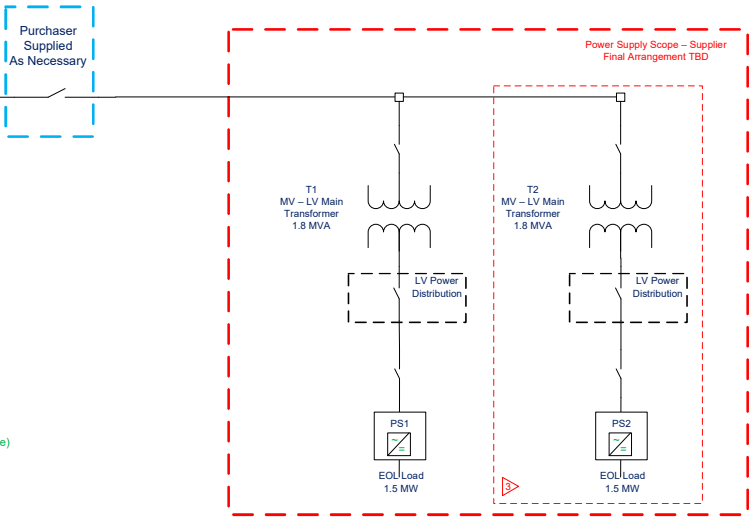
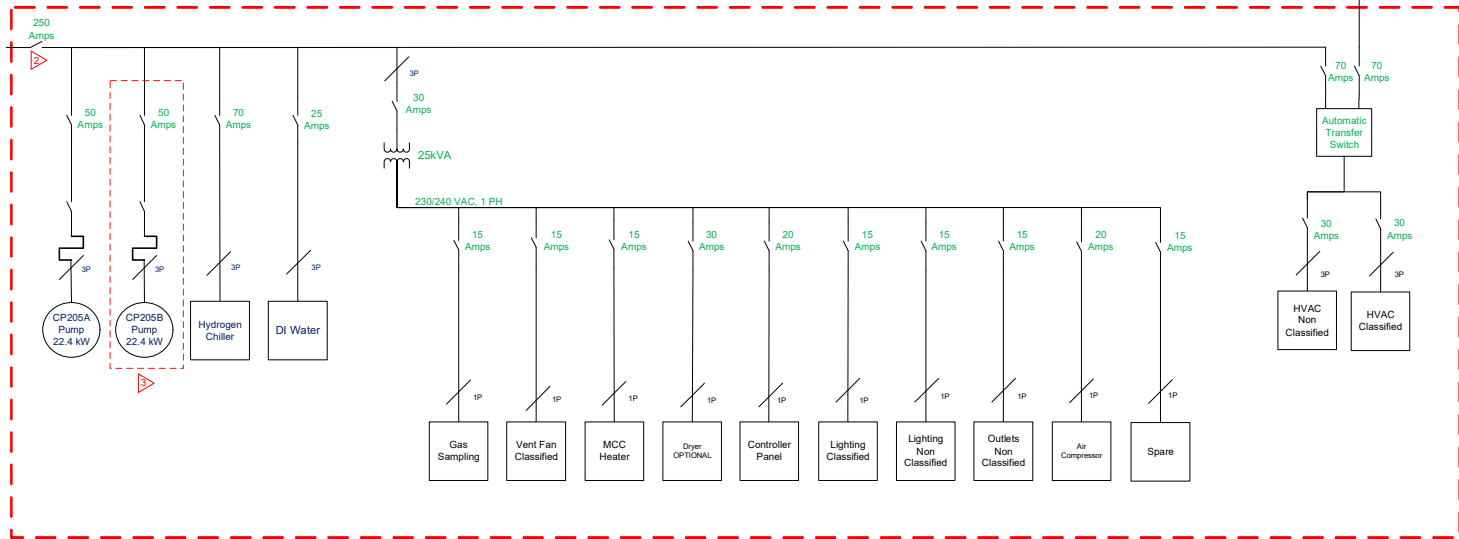

10 kVAC,
3 PH, 4 Wire 60 Hz
(Other MV feeds also available)
Purchaser Supplied
MV Grid

Purchaser Supplied
As Necessary

Power Supply Scope - Supplier
Final Arrangement TBD

Electrical Standards for:	EU	US / CAN
Top Level	IEC 60204-1, Safety of machinery – Electrical equipment of machines – Part 1: General requirements	NFPA 79 Electrical Standard for Industrial Machinery (NFPA 79 Recognizes many of the IEC and ISO publications mentioned in the EU Column)
	ISO 22734-1:2008 Hydrogen generators using water electrolysis process – Part 1: Industrial and commercial applications	
	ISO 22724:2019 Hydrogen generators using water electrolysis – Industrial, commercial, and residential applications	
Component selection-general	IEC 61010-1:2010, Safety requirements for electrical equipment for measurement, control, and laboratory use – Part 1: General requirements	NFPA 79 Electrical Standard for Industrial Machinery
	IEC 60947-7-1, Low-voltage switchgear and controlgear – Part 7-1: Ancillary equipment – Terminal blocks for copper conductors	
	IEC 60947-7-2, Low-voltage switchgear and controlgear – Part 7-2: Ancillary equipment – Protective conductor terminal blocks for copper conductors	
	IEC 60998-2-2, Connecting devices for low-voltage circuits for household and similar purposes – Part 2-2: Particular requirements for connecting devices as separate entities with screwless-type clamping units	
	IEC 60999-1, Connecting devices – Electrical copper conductors – Safety requirements for screw-type and screwless-type clamping units – Part 1: General requirements and particular requirements for clamping units for conductors from 0,2 mm ² up to 35 mm ² (included)	
Controllers	IEC 60999-2, Connecting devices – Electrical copper conductors – Safety requirements for screw-type and screwless-type clamping units – Part 2: Particular requirements for clamping units for conductors above 35 mm ² up to 300 mm ² (included)	NFPA 79 Electrical Standard for Industrial Machinery
	IEC 61131-1, Programmable controllers – Part 1: General information	
Safety Controllers	IEC 61131-2, Programmable controllers – Part 2: Equipment requirements and tests	NFPA 79 Electrical Standard for Industrial Machinery
	IEC 61508-1, Functional safety of electrical/electronic/programmable electronic safety-related systems – Part 1: General requirements	
	IEC 61508-2, Functional safety of electrical/electronic/programmable electronic safety-related systems – Part 2: Requirements for electrical/electronic/programmable electronic safety-related systems	
Wire / cables	IEC 61511-1, Functional safety: Safety instrumented systems for the process industry sector – Part 1: Framework, definitions, system, hardware and software requirements	NFPA 79 Electrical Standard for Industrial Machinery NFPA 70 National Electrical Code
	IEC 60364-5-52 Low-voltage electrical installations – Part 5-52: Selection and erection of electrical equipment – Wiring systems	
power supplies	IEC 61204-6, Low-voltage power supplies, d.c. output – Part 6: Requirements for low-voltage power supplies of assessed performance	NFPA 79 Electrical Standard for Industrial Machinery
	IEC 60947-4-1, Low-voltage switchgear and controlgear – Part 4-1: Contactors and motor-starters – Electromechanical contactors and motor-starters	
selection of contactors	IEC 60947-4-2, Low-voltage switchgear and controlgear – Part 4-2: Contactors and motor-starters – AC semiconductor motor controllers and starters	NFPA 79 Electrical Standard for Industrial Machinery
	IEC 60947-4-3, Low-voltage switchgear and controlgear – Part 4-3: Contactors and motor-starters – AC semiconductor controllers and contactors for non-motor loads	
	IEC 60947-5-1, Low-voltage switchgear and controlgear – Part 5-1: Control circuit devices and switching elements – Electromechanical control circuit devices	
Over current devices	IEC 60364-4-43, Electrical installations of buildings – Part 4-43: Protection for safety – Protection against overcurrent	NFPA 79 Electrical Standard for Industrial Machinery
	IEC/TR 61459, Coordination between fuses and contactors/motor-starters – Application guide	
method of design / construction	IEC 60664-1, Insulation coordination for equipment within low-voltage systems – Part 1: Principles, requirements and tests	UL508A NFPA 79 Electrical Standard for Industrial Machinery
	IEC 60364-1, Low-voltage electrical installations – Part 1: Fundamental principles, assessment of general characteristics, definitions	
	IEC 60364-5-53:2001, Electrical installations of buildings – Part 5-53: Selection and erection of electrical equipment – Isolation, switching and control	
	IEC 60364-5-53:2001/AMD1:2002	
	IEC 60445:2010, Basic and safety principles for man-machine interface, marking and identification – Identification of equipment terminals, conductor terminations and conductors	
	IEC 61140, Protection against electric shock – Common aspects for installation and equipment	

**Electrical
Standards for:**

EU

US / CAN

Grounding and bonding	IEC 60364-4-41, Low voltage electrical installations — Part 4-41: Protection for safety — Protection against electric shock	IEEE Std 1100 IEEE Recommended Practice for Powering and Grounding Electronic Equipment
	IEC 60364-5-54, Low-voltage electrical installations – Part 5-54: Selection and erection of electrical equipment – Earthing arrangements and protective conductors	NFPA 79 Electrical Standard for Industrial Machinery
Disconnects / breakers	IEC 60947-2, Low-voltage switchgear and controlgear – Part 2: Circuit-breakers	NFPA 79 Electrical Standard for Industrial Machinery
	IEC 60947-3, Low-voltage switchgear and controlgear – Part 3: Switches, disconnectors, switch-disconnectors, and fuse-combination units	UL 489, Standard for Molded-Case Circuit Breakers, Molded-Case Switches, and Circuit-Breaker Enclosures, 2009, revised 2014.
	IEC 60947-6-2, Low-voltage switchgear and controlgear – Part 6-2: Multiple function equipment – Control and protective switching devices(or equipment) (CPS)	
	IEC 60664-1, Insulation coordination for equipment within low-voltage systems – Part 1: Principles, requirements and tests	
Motors	IEC 60034-1, Rotating electrical machines — Part 1: Rating and performance	NFPA 79 Electrical Standard for Industrial Machinery
E-Stops	IEC 60947-5-5, Low-voltage switchgear and controlgear – Part 5-5: Control circuit devices and switching elements – Electrical emergency stop device with mechanical latching function	NFPA 79 Electrical Standard for Industrial Machinery
	ISO 13850, Safety of machinery — Emergency stop — Principles for design	ISO 13850, Safety of machinery — Emergency stop — Principles for design
Switchgear	IEC 61439-1, Low-voltage switchgear and controlgear assemblies – Part 1: General rules-	ANSI/IEEE C37.20.1. EEE Standard For Metal-Enclosed Low-Voltage (1000 Vac And Below, 3200 Vdc And Below) Power Circuit Breaker Switchgear
Plug / sockets	IEC 60309-1, Plugs, socket-outlets, and couplers for industrial purposes – Part 1: General Requirements	UL 61010
Safety devices	IEC 60364-4-41:2005, Low-voltage electrical installations – Part 4-41: Protection for safety – Protection against electric shock	NFPA 79 Electrical Standard for Industrial Machinery
	IEC 62061, Safety of machinery – Functional safety of safety-related electrical, electronic and programmable electronic control systems	
	ISO 13849-1, Safety of machinery – Safety-related parts of control systems – Part 1: General principles for design	
	ISO 13849-2, Safety of machinery – Safety-related parts of control systems – Part 2: Validation	

Mechanical standards for:

EU

US /CAN

Top Level	IEC 60204-1, Safety of machinery – Electrical equipment of machines – Part 1: General requirements	
	ISO 22734-1:2008 Hydrogen generators using water electrolysis process – Part 1: Industrial and commercial applications	ASME
	ISO 22724:2019 Hydrogen generators using water electrolysis – Industrial, commercial, and residential applications	
Enclosures	ISO 1182, Reaction to fire tests for building products — Non-combustibility test	NFPA 2 Hydrogen Technologies
	IEC 60529, Degrees of protection provided by enclosures (IP Code)	
Pressure relief systems	ISO 4126-1, Safety devices for protection against excessive pressure — Part 1: Safety valves	ASME BVPC Section VIII-DIV 1
	ISO 4126-2, Safety devices for protection against excessive pressure — Part 2: Bursting disc safety devices	ASME BVPC Section VIII
	ISO 4126-6, Safety devices for protection against excessive pressure — Part 6: Application, selection and installation of bursting disc safety devices	
Fans	ISO 12499, Industrial fans — Mechanical safety of fans — Guarding	ASME PTC 11
	IEC 60335-2-80, Household and similar electrical appliances — Safety — Part 2-80: Particular requirements for fans	UL 507
Pumps	ISO 14847 Rotary positive displacement pumps — Technical requirements	
	ISO 13709 Centrifugal pumps for petroleum, petrochemical and natural gas industries	ANSI/API Standard 610 Centrifugal Pumps for Petroleum, Petrochemical and Natural Gas Industries
	IEC 60335-2-41, Household and similar electrical appliances — Safety — Part 2-41: Particular requirements for pumps	ANSI /ASME B73 pump standards
	IEC 60335-2-51, Household and similar electrical appliances — Safety — Part 2-51: Particular requirements for stationary circulation pumps for heating and service water installations	
Vessels	ISO 16528-1, Boilers and pressure vessels — Part 1: Performance requirements	ASME BVPC Section VIII-DIV 1
	EN 13445-3 Unfired pressure vessels Part 3 Design	
Piping / tubing	ASME Recognized	ASME B31.12 Hydrogen Piping and Pipelines
Hydrogen Vents	ISO 15649, Petroleum and natural gas industries — Piping	ASME B31.3 process piping
	EIGA Doc_211_17_Hydrogen_Vent_Systems_for_Customer_Applications	CGA G-5.5 Hydrogen Vent Systems
Oxygen Vents	EIGA Doc_154_16_Safe_Location_of_Oxygen_and_Inert_Gas_Vents	
Gas Cylinders	ISO 7866, Gas cylinders — Refillable seamless aluminium alloy gas cylinders — Design, construction and testing	ASME
	ISO 9809-1, Gas cylinders — Refillable seamless steel gas cylinders — Design, construction and testing — Part 1: Quenched and tempered steel cylinders with tensile strength less than 1 100 MPa	DOT
	ISO 11119-1, Gas cylinders — Refillable composite gas cylinders and tubes — Design, construction and testing — Part 1: Hoop wrapped fibre reinforced composite gas cylinders and tubes up to 450 l	
	ISO 11119-2, Gas cylinders — Refillable composite gas cylinders and tubes — Design, construction and testing — Part 2: Fully wrapped fibre reinforced composite gas cylinders and tubes up to 450 l with load-sharing metal liners	
	ISO 11119-3, Gas cylinders — Refillable composite gas cylinders and tubes — Design, construction and testing — Part 3: Fully wrapped fibre reinforced composite gas cylinders and tubes up to 450L with non-load-sharing metallic or non-metallic liners	
Gas Flow	ISO 9300, Measurement of gas flow by means of critical flow Venturi nozzles	
	ISO 9951, Measurement of gas flow in closed conduits — Turbine meters	
	ISO 10790, Measurement of fluid flow in closed conduits — Guidance to the selection, installation and use of Coriolis flowmeters (mass flow, density and volume flow measurements)	
Generals Design	ISO 14511, Measurement of fluid flow in closed conduits — Thermal mass flowmeters	
	ISO 13854, Safety of machinery — Minimum gaps to avoid crushing of parts of the human body	ANSI B11.0 Safety of Machinery
	ISO 13857, Safety of machinery — Safety distances to prevent hazard zones being reached by upper and lower limbs	
	ISO 15534-1, Ergonomic design for the safety of machinery — Part 1: Principles for determining the dimensions required for openings for whole-body access into machinery	
Valves	ISO 15534-2, Ergonomic design for the safety of machinery — Part 2: Principles for determining the dimensions required for access openings	
	IEC 60534 (all parts), Industrial-process control valves	

Safety / hazard /risk	EU	USA/CAN
Top Level	IEC 60204-1, Safety of machinery – Electrical equipment of machines – Part 1: General requirements	NFPA 2 Hydrogen Technologies Code
	ISO 22734-1:2008 Hydrogen generators using water electrolysis process – Part 1: Industrial and commercial applications	
	ISO 22724:2019 Hydrogen generators using water electrolysis – Industrial, commercial, and residential applications	
Risk assessment / management	ISO 14121-1, Safety of machinery – Risk assessment – Part 1: Principles (revised /replaced by ISO 12100)	ISO 12100
	ISO 12100, Safety of machinery – General principles for design – Risk assessment and risk reduction	
	IEC 61882 Hazard and operability studies (HAZOP studies) – Application guide	ANSI B11.19 Performance Requirements for Risk Reduction Measures: Safeguarding and other Means of Reducing Risk
	IEC 31010:2019, Risk management – Risk assessment techniques	
Explosive atmospheres	IEC 60079-0, Explosive atmospheres – Part 0: Equipment – General requirements	NFPA 70 National Electric Code
	IEC 60079-2:2007: Explosive atmospheres – Part 2: Equipment protection by pressurized enclosures "p"	NFPA 2 Hydrogen Technologies Code
	IEC 60079-10, Electrical apparatus for explosive gas atmospheres – Part 10: Classification of hazardous Areas	IEC Accepted by most AHJ
	IEC 60079-14, Explosive atmospheres – Part 14: Electrical installations design, selection and erection	
	ISO 13852, Safety of machinery – Safety distances to prevent danger zones being reached by the upper limbs	NFPA 79 Electrical Standard for Industrial Machinery
Personnel	ISO 13853, Safety of machinery – Safety distances to prevent danger zones being reached by the lower limbs	OSHA
	ISO 13854, Safety of machinery – Minimum gaps to avoid crushing of parts of the human body	
CG Sensors	IEC 60079-29-1, Explosive atmospheres – Part 29-1: Gas detectors – Performance requirements of detectors for flammable gases	NFPA 2 Hydrogen Technologies Code
	ISO 26142, Hydrogen detection apparatus – Stationary applications	
Labeling	IEC 60417, Graphical symbols for use on equipment	
Fire	ISO 1182, Reaction to fire tests for products – Non-combustibility test	NFPA- Multiple
	IEC 60695-11-10, Fire hazard testing – Part 11-10: Test flames – 50 W horizontal and vertical flame test methods	
	IEC 60695-11-20, Fire hazard testing – Part 11-20: Test flames – 500 W Flame test methods	
Sound	ISO 3746, Acoustics – Determination of sound power levels and sound energy levels of noise sources using sound pressure – Survey method using an enveloping measurement surface over a reflecting plane	OSHA /ANSI
	ISO 9614-1, Acoustics – Determination of sound power levels of noise sources using sound intensity – Part 1: Measurement at discrete points	ANSI/ASA S12.19
	IEC 61672-1, Electroacoustics – Sound level meters – Part 1: Specifications	
	IEC 61672-2, Electroacoustics – Sound level meters – Part 2: Pattern evaluation tests	



BUDGETARY QUOTE

Proton® PEM Water Electrolysis
One (1) MC250 (246Nm³/h, ~1.25MW)

Quote N°: Q-03040-20210319

Site Location: Winnipeg, Canada

Prepared for: Dillon Consulting Limited
Attn.: Sean Russell
130 Dufferin Avenue Suite 1400
London, Ontario, N6A 5R2

Date: 19 March 2021

Expires: 18 June 2021

Your Contact: Matt Weaver
mweaver@nelhydrogen.com
+1 203 678 2195

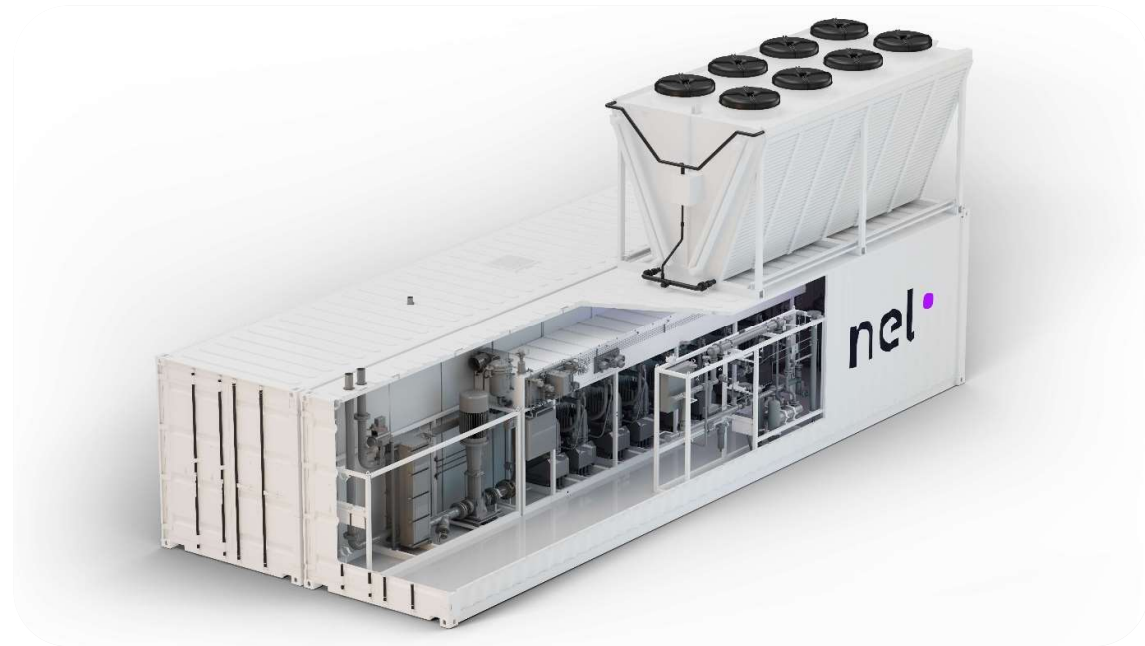

NEL Hydrogen

Proton Energy Systems, Inc d/b/a Nel Hydrogen US
10 Technology Drive
Wallingford, CT 06492, USA
+1 203 678 2000
www.nelhydrogen.com

1	SOLUTION OVERVIEW	3
1.1	SYSTEM GENERAL SPECIFICATIONS ¹	3
1.2	UTILITIES REQUIREMENTS	3
2	PRICING & SCOPE	4
2.1	MAIN SYSTEM & OPTIONS	4
2.2	ENGINEERING SERVICES / CONSUMABLES & RECOMMENDED SPARES	5
2.3	RESPONSIBILITIES FOR ONSITE WORKS	5
2.4	WARRANTY	6
2.5	SPECIAL CONSIDERATIONS	6
3	DELIVERY	6
3.1	READINESS FOR SHIPMENT ¹	6
3.2	DELIVERY TERMS	6
4	ENGINEERING SERVICES OVERVIEW	7
4.1	SUPERVISION/COORDINATION	7
4.2	STARTUP, COMMISSIONING, AND TRAINING	7
4.3	SUPPORT & MAINTENANCE	7
5	ANNEXES	8
6	CODES & STANDARDS	8
7	DISCLOSURE	8
8	TERMS & CONDITIONS	9
8.1	GENERAL TERMS & CONDITIONS	9
8.2	LIMITED WARRANTY	10

1 SOLUTION OVERVIEW

Choosing a **Nel Proton® PEM** water electrolyser offers you a technology operating at thousands of sites globally for over 60 years. **Safety & reliability** of our systems are unequalled today. Nel offers you a **de-risked** technology and a **committed & trusted** partner for a worryless experience. With Nel and its global certified partners you simply get the best along the entire supply chain.

1.1 SYSTEM GENERAL SPECIFICATIONS¹

H ₂ maximum capacity at plant outlet:	246 (531)	Nm ³ /h (Kg/day)
Site location / Standards:	Outdoors (Containerized) / CE and US	
Ambient T°:	Extended: -30°C to +43°C (-22°F to 110°F)	
Altitude:	Maximum 1,000 meters (3,280Ft) above sea level	
Sound Pressure Level (SPL) @ 1m:	< 85	dB
Turndown Ratio:	10-100	%
Reaction Time:	< 10 sec. from 10-100%	Seconds
H ₂ maximum pressure at electrolyser:	30 (no compressor)	Barg
H ₂ purity at outlet of proposed solution:	99.9995% (H₂O<5ppm, N₂<2ppm, O₂<1ppm, all others undetectable). Fuel Cell Grade quality. Meets ISO 14687:2019(E) Type 1, Type II Grade D & SAE J-2719 Type I grade L	
Expected power consumption at stack BOL (10-100%):	4.1 - 4.9	kWh/Nm ³
Expected power consumption for system BOL (100%) ² :	5.4	kWh/Nm ³
Expected degradation:	<1	%/year

¹: BOL (beginning of life), at full capacity (100%), after dryer, according to Nel's scope delivered, under standard operating conditions (1atm, 20°C), with utilities according to specifications, and if preventive maintenance was performed according to Nel's manual.

²: Complete system according to main system description below, excluding cooling (usually around 0.1kWh/Nm³ in normal conditions but can be higher in hot environment)

1.2 UTILITIES REQUIREMENTS

To ensure an optimally functioning system, utilities are required to be in accordance with **Appendix A2 & A3**. Unless appropriate utilities are provided by equipment supplied by NEL, it is the responsibility of the BUYER to make them available. For this specific solution, the following utilities need to be provided by the BUYER:

- With standard offered scope: Tap water, Input power switchgear (MV & LV), Backup power (for heaters), N₂ (3-4 bottles. Seldomly used).

2 PRICING & SCOPE

2.1 MAIN SYSTEM & OPTIONS

Main Price: \$2,348,729 USD



Proton® PEM Electrolyser Main Scope

One (1) system(s) for outdoors (containerized) installation each including:

- **Electrolysis process:**
 - 246 (531) Nm³/h (kg/day)
 - Water & Oxygen Management System (WOMS)
 - 0-30barg H₂ pressure (No compressor)
 - Highly safe full differential pressure (Atm O₂, 30barg H₂)
 - Proton® PEM Cell stack(s)
 - Hydrogen Gas Management System (HGMS): 99.9% purity
 - Internal Water Polisher
 - All needed safety equipment (Flame Detector, CG sensors,...)
- **Electrical and Controls:**
 - MV Transformer(s) (Dry Type, integrated in containers)
 - AC-DC Rectifier(s)
 - MCC (Motor Control Center)
 - PLC based control panel w HMI
- **Others:**
 - Piping & Wiring for equipment supplied
 - Standard Documentation Package
 - Project Management Support / Kick Off Meeting for up to 2 days



Peripheral Equipment

Each system includes:

<input checked="" type="checkbox"/> <input type="checkbox"/>	RO/EDI Water Purification System	1
<input checked="" type="checkbox"/> <input type="checkbox"/>	H ₂ Dryer including dew point meter	1
<input checked="" type="checkbox"/> <input type="checkbox"/>	Instrument Air Compressor	1
<input checked="" type="checkbox"/> <input type="checkbox"/>	All equipment above and in main scope included in 1x40ft. high cube container and 1 x 20 ft high cube container for rectifiers	1
<input checked="" type="checkbox"/> <input type="checkbox"/>	Vents for O ₂ and H ₂ of electrolyzer	1
<input checked="" type="checkbox"/> <input type="checkbox"/>	TCU (Dry Cooler for process cooling), roof mounted, Max. ambient 43°C. No water spray required	1

: Included in main price. : not included in main price.

2.2 ENGINEERING SERVICES / CONSUMABLES & RECOMMENDED SPARES

Consumables are required parts to perform preventive maintenance on the system and need to be taken to ensure warranty terms. **Recommended Spares** are parts the BUYER can have on inventory for fast replacement preventing delivery lead time, in an unlikely event these would fail and trigger a shutdown of the system.

Engineering Services ¹ (in USD)		Consumables Kits (in USD)			Recommended Spares Kits (in USD)		
Onsite Supervision/Coordination	47,500	Y1 H ₂ Generator	1	6,000	Kit H ₂ Generator	1	48,000
Startup & Commissioning and Training	47,500	Y2 H ₂ Generator	1	8,400	Kit DI/RO Water System ²	1	11,000
		1Y RO/EDI Water System ²	1	4,500			

¹: Price shown is for onsite labor only. Travels, Lodging, and Allowances are billed at actual.

²: Price of DI/RO water kit might change depending on input water quality if different from Nel required specs.

³: Shipped separately. Needs to be available at startup & commissioning.

2.3 RESPONSIBILITIES FOR ONSITE WORKS



¹: Between Nel’s containers in line with Nel’s supplied standard GA. Any changes in positioning of the equipment onsite might incur extra costs. All connections of utilities (if not supplied by Nel’s equipment) to our terminal points of the battery limit are the scope of the BUYER. Does not include connections to compressor, storage, and cooling unit.

²: Installation & Interconnection labor of Nel’s delivered equipment.

2.4 WARRANTY

- 15 Months from readiness for shipment or 12 Months from startup & commissioning whichever occurs first.

2.5 SPECIAL CONSIDERATIONS

All equipment manufactured in accordance with CE and US codes and standards. Special conditions or certification efforts for installation in Canada is not fully known at this time and not included in the price.

3 DELIVERY

3.1 READINESS FOR SHIPMENT¹

Ready to ship 11 months from project start-up date.

¹: Readiness for Shipment will be confirmed at Contract’s signature date. The Project Start-up Date is the date of signing of contract or receipt of Advance Payment, whichever comes last.

3.2 DELIVERY TERMS

EXW Origin (According to Incoterms 2020):

Equipment	Shipping Location
Process (Electrolyser) Container	Connecticut, USA
Power Supply Container(s)	Germany
TCU Cooling System	Germany
Tariff Codes: Electrolyser Skid & Stacks: 84.05.10.0000; All others (Incl. Cal. Gas): 84.05.90.0000	
Equipment	Shipping Estimated Packing
Process (Electrolyser) Container	1 x 40Ft. Modified High Cube Container
Power Supply Container	1 x 20Ft. Modified High Cube Container
TCU Cooling System	1 x 40Ft. Flat rack

4 ENGINEERING SERVICES OVERVIEW

4.1 SUPERVISION/COORDINATION

Site supervision/coordination to ensure proper installation for smooth startup and includes support of customer in the supervision of:

- Hydrogen plant placement and securing
- Plumbing routing and installation between Hydrogen Generation equipment
- Electrical routing, hookup and installation between the hydrogen plant and facility interfaces

Supervision/coordination efforts include oversight of connections both between the Hydrogen Generator Skids and from the host facility to the Hydrogen Generator Skids. The interconnection efforts assume the availability of customer supplied and supervised personnel (local trades, plumbers, electricians, etc.) to perform the interconnection activities. Nel will send certified personal to your site for up to **20** person days to support the installation effort. In case additional days are required due to factors independent from Nel's scope of supply, additional costs of 2,727USD/day per person will be charged (8 hours/day). This price is based on a single trip. Travels, lodging, and allowances are billed at actual.

4.2 STARTUP, COMMISSIONING, AND TRAINING

This will cover:

- Review of hydrogen plant installation
- Start up and initial operation of hydrogen plant
- Verification of operational parameters
- Training on Daily Operations, Maintenance, Troubleshooting, and use of Operating Manuals for provided equipment

Nel will send certified personal to your site for up to **20** person days after the system has been properly installed, and all connections and civil works have been completed. In case additional days are required due to factors independent from Nel's scope of supply, additional costs of 2'725USD/day per person will be charged (8 hours/day). In addition, preparation, travel time, weekend cost (if needed) are also included in the price. This price is based on a single trip. Travels, lodging, and allowances are billed at actual.

4.3 SUPPORT & MAINTENANCE

Nel maintains a highly qualified service team, with an extended network of Nel-Certified service providers around the world. Thanks to this strong organization, we can support the entire fleet of installed systems providing commissioning, training, preventive maintenance, service contracts, and field support.

The service organization is accessible 24/7 via telephone and email and ensures rapid customer service is maintained. The service organization, as well as the rest of

the company, is a metrics-driven organization that tracks data such as customer response time and component reliability. These parameters are used to drive continuous improvement within our organization, and to support installed hydrogen generation systems world-wide. Annual service contracts are available on request with preventive maintenance coverage.

5 ANNEXES

- A1: Technical Specification Sheet
 - A2: Utilities Requirements Overview
 - A3: DI Water Requirements
 - A4: Simplified Process Flow Diagram
 - A5: MC250 General Arrangement
 - A6: M-Series MC500 Eff vs Output
- A9: MC250 Single Line Diagram
 - A11: M Series Design Standards Guide
 - A13: Maintenance Intervals Overview M Series

6 CODES & STANDARDS

Safety and quality are designed into every system we build. In addition to our inherently safe system architecture and decades of field experience, there are currently thousands of Nel electrolyzers operating in the field. To assure the utmost in reliability and safety, Nel follows the most rigorous US and international design standards available today. A declaration of conformity will be provided with the delivered equipment.

7 DISCLOSURE

This document is considered CONFIDENTIAL & PROPRIETARY and COMPETITION SENSITIVE by Nel Hydrogen / Proton Energy Systems, Inc. d/b/a Nel Hydrogen US and is delivered on the express condition that it is not to be disclosed, reproduced, in whole or in part, without the written consent of Proton OnSite and that no right is granted to disclose or so use any information contained in said document.

Wallingford, CT, USA, 19 March 2021
NEL Hydrogen
Matt Weaver
Business Development Manager – North America

8 TERMS & CONDITIONS

8.1 GENERAL TERMS & CONDITIONS

PROTON ENERGY SYSTEMS INC. d/b/a NEL HYDROGEN US ("NEL HYDROGEN")

PRICES - Prices are ExWorks, Proton Energy Systems Inc. d/b/a Nel Hydrogen US (NEL HYDROGEN) plant, Wallingford, Connecticut, USA, unless otherwise stated. Prices do not include any Municipal, State, or Federal, sales, excise, import, export duties or similar taxes. In addition to the prices specified, the amount of any present or future sales, use, excise, or other tax imposed shall be paid by the BUYER unless the BUYER provides NEL HYDROGEN with a tax exemption certificate from the appropriate taxing authority. Where applicable, customs duties, consular fees and insurance charges shall be borne by BUYER. Until confirmed in writing or by acceptance of order or contract, all prices or leasing rates contained in quotations, catalogs, price lists and advertisements are subject to change without notice.

TERMS OF PAYMENT

- A) Milestone 1 – 30% of contract value upon receipt of order.
- B) Milestone 2 – 30% of contract value upon order of major components, to be agreed by BUYER and NEL HYDROGEN, and as evidenced by NEL HYDROGEN representation with purchase order reference.
- C) Milestone 3 – 30% of contract value upon shipment.
- D) Milestone 4 – 10% of contract value upon commissioning and training or 120 days after shipment, whichever comes first.

CANCELLATION AND RETURNS - No goods may be returned for credit, repair, or replacement without prior NEL HYDROGEN approval. In the event unauthorized return shipments are made to NEL HYDROGEN, NEL HYDROGEN reserves the right to refuse the shipment. It will be held as the BUYER's property without responsibility to NEL HYDROGEN. All return shipments shall be at BUYER's expense.

SHIPMENTS AND DELIVERY - NEL HYDROGEN puts great emphasis on timely delivery, however, shipping dates are estimates and deliveries are subject to delays. NEL HYDROGEN shall not be liable for any damages or penalties for delays or defaults in manufacture, delivery or shipment, or for failure to give notice of delay and such delay shall not constitute grounds for cancellation. Unless otherwise specified, products will be delivered Ex Works, Proton Onsite plant, Wallingford, CT, USA, packaged and/ or boxed in accordance with NEL HYDROGEN commercial practices for USA domestic delivery. When other delivery terms are agreed to, as applicable, NEL HYDROGEN will pack and / or box in accordance with NEL HYDROGEN commercial practices for shipment and select appropriate transportation, freight forwarding and insurance for the BUYER. Title to products shall pass to BUYER on delivery. NEL HYDROGEN products are packaged to protect against reasonable damage or deterioration; however, NEL HYDROGEN will not be responsible for loss or damage in transit unless otherwise expressly agreed.

SCHEDULE - The BUYER is responsible to assure that the site, access and material handling equipment is ready for the scheduled delivery of product per the Engineering Specifications, Layout Documents and Schedule. If components are available for shipment and the BUYER delays shipment of these components, through no fault of NEL HYDROGEN, for more than 10 days from the original ship date on the purchase order, then any unpaid balances will become immediately due and payable.

PRODUCT CHANGES - NEL HYDROGEN reserves the right to: (a) make changes in design, specifications, processes of manufacture and construction of its products, without notice, provided such changes do not materially affect performance; and (b) may affect such changes described in (a), without incurring any obligation to make such changes to articles previously purchased.

APPLICABLE LAW - This Agreement, and all questions arising in connection herewith, shall be governed by and construed in accordance with the laws of the State of Connecticut, USA and applicable federal laws of the United States of America.

CELL STACK RESTRICTION - The BUYER recognizes that the cell stack embodies confidential and proprietary information and trade secrets of NEL HYDROGEN. The BUYER agrees not to disassemble or reverse engineer any cell stack, either supplied as part of a system or as a separate item. The BUYER hereby acknowledges that NEL HYDROGENS remedy at law for breach of this restriction is inadequate, and that NEL HYDROGEN shall have the right to injunctive relief in the event of any such breach in addition to any other remedy available to it. In addition, the BUYER hereby acknowledges that breach of this restriction immediately voids any cell stack warranty. BUYER hereby acknowledges that this restriction applies to any and all employees, agents, successors, or assigns and that the BUYER shall take all reasonable measures to ensure compliance with this restriction.

LIABILITY - NEL HYDROGENS exclusive liability with respect to its products sold hereunder is set forth in its written WARRANTY accompanying these TERMS AND CONDITIONS. In no event shall NEL HYDROGEN be liable for loss of profits or incidental, indirect, special, consequential or other similar damages arising out of any breach of this contract.

RECYCLED CONTENT - NEL HYDROGEN reserves the right to utilize reclaimed, recycled, refurbished or other post-consumer materials in finished goods and packaging materials. Such materials are subject to the written WARRANTY, if any, accompanying these TERMS AND CONDITIONS.

PLANT PIPING, ELECTRICAL CONNECTION AND COMMUNICATION LINKS

- A) The plant piping refers to a standard design to operate within an area as detailed in NEL HYDROGEN's General Arrangement Drawing dated ____.
- B) The piping bridges and supports, cable trays conduits and supports within the operating area and the wall penetrations necessary for the plant piping and wiring are to be executed by the BUYER and must be agreed upon with NEL HYDROGEN beforehand.
- C) For avoidance of doubt, this non-exclusive list of services are not covered by NEL HYDROGEN:
 - i. Hydrogen gas lines after the output flanges of the process skid_____.
 - ii. Mounting of NEL HYDROGEN provided check valve and pressure transducer to be mounted in Hydrogen product line downstream of the hydrogen output flange.
 - iii. Water Drain lines outside the process racks.
 - iv. H₂ and Oxygen vent exhaust gas lines and/or chimney and/or ducting outside the operating area.
 - v. Pneumatic supply line per NEL HYDROGEN specifications.

SPARE PARTS AND CONSUMABLES To be specified in the purchase order.

DOCUMENTATION

- A) The documentation to be delivered by NEL HYDROGEN shall consist of the following, as a minimum:
- i. M Series Installation manual
 - ii. M Series Maintenance Manual
 - iii. M Series Operation Manual
 - iv. Manuals for major devices (e.g. power supplies, combustible gas sensors, level sensors, control valve assemblies, pumps, etc.)
 - v. Electrolyzer electrical schematic and P&ID
 - vi. Mechanical and electrical interface diagram(s)
 - vii. Commissioning Service report
 - viii. M Series Product Specification
- B) All documents to be produced or adapted specifically to this project will be issued in English.
- C) Format of drawings shall be in NEL HYDROGEN standard format.

BUYER PROVIDED SERVICES, RESPONSIBILITIES AND EQUIPMENT - BUYER requirements: Access to site by NEL HYDROGEN personnel. Access roads, planned building and/or foundations, electricity, water and sewage hook-ups. Assurance that NEL HYDROGEN personnel can begin work immediately upon arrival at the site. Assurance that work by NEL HYDROGEN personnel, at the site, will be efficient and without interruption.

Extra work required beyond normal planned hours for conditions out of NEL HYDROGEN control shall be reimbursable at the agreed rates by the BUYER. Materials and equipment to be available in sufficient scope for the duration of assembly and commissioning:

8.2 LIMITED WARRANTY

HYDROGEN GAS GENERATOR SYSTEMS

LIMITED WARRANTY: Proton energy systems Inc. d/b/a Nel Hydrogen US ("NEL HYDROGEN") warrants that the ITEMS LISTED BELOW shall be free from defects in material and workmanship for the period of time stated below. Generator System: Twelve (12) months from shipment. Repair or replacement parts for Generator System: Ninety (90) days from shipment.

EXCLUDED FROM THIS LIMITED WARRANTY: the following shall be excluded from the Limited Warranty:

- Parts and items considered consumable in normal operations, including those parts and items supplied with the Generator System ("System") for maintenance.
- Any Generator and its parts that are not installed, operated, and maintained in accordance with the unit's operation and maintenance manuals supplied with the System.
- Damages due to accident, abuse, acts of God, acts of terrorism, misuse or negligence, or which result, in whole or in part, from improper or unauthorized use or repair of the System, or use of the System in a manner for which it was not designed, or by causes external to the System such as, but not limited to, power or air conditioning failure or voltage irregularities.

REMEDY: BUYER's sole and exclusive remedy in the event of defect and the liability of NEL HYDROGEN hereunder is limited to the adjustment, repair, or replacement of the defective item or part with a similar item or part free of defect. Such adjustments, repairs, or replacements will be made at NEL HYDROGEN's Wallingford, Connecticut, plant or, for Generators only, at the site of the generator, if

1. Electrical power and fresh water.
2. Sanitary facilities, locked storage area for replacement parts and tools, office and rooms for 2-3 employees and internet connection. Non-freezing storage area for staging cell stacks.
3. Truck/crane and appropriate personnel for loading components and moving them to assembly locations or placing them in entrance area to the facility. The heaviest load to lift is estimated to be weight max 7110kg (2MW)_____.
4. Forklift with tires for flat loading surface. If internal surface is uneven then a higher loadable lifting device may be required.
5. Skilled labor/local trades to perform/assist with installation and start-up of hydrogen generation equipment.

NEL HYDROGEN PROVIDED SERVICES - INSTALLATION SUPERVISION, START-UP, COMMISSIONING AND TRAINING - Installation: NEL HYDROGEN employees will be available to support assembly and installation of hydrogen generation equipment at site. Start Up/commissioning: NEL HYDROGEN employees will be responsible for plant start-up/commissioning. Unless otherwise agreed to in writing, NEL HYDROGEN's standard protocol for commissioning and turn-over will be used. Training: Training of BUYER personnel will be provided by NEL HYDROGEN personnel after start-up of plant. The training will take place at the delivered system on the basis of the system documentation delivered as per the contractual agreement. Additional training documents are not included in the base scope of the project.

BUYER so elects. all costs for shipping equipment or parts shall be on the account of the BUYER whether to or from the point of manufacture. Labor costs associated with travel, expenses, and subsistence costs for field services shall be on the account of the BUYER.

VOIDING OF THE LIMITED WARRANTY: This Limited Warranty is immediately void upon: THE DISASSEMBLY OF THE ELECTROLYSIS CELL STACK, OR THE SALE, ASSIGNMENT OR ANY OTHER TRANSFER OF TITLE BY BUYER OF THE ITEMS OR PARTS OTHERWISE COVERED UNDER THIS LIMITED WARRANTY WITHOUT THE PRIOR AGREEMENT OF NEL HYDROGEN.

WAIVER OF ALL OTHER WARRANTIES: THE LIMITED WARRANTY PROVIDED HEREUNDER AND THE RIGHTS AND REMEDIES OF THE BUYER HEREUNDER ARE IN LIEU OF, AND BUYER EXPRESSLY WAIVES, ALL OTHER WARRANTIES, GUARANTEES, OBLIGATIONS, LIABILITIES, OR REMEDIES, EXPRESSED OR IMPLIED, ARISING BY LAW OR OTHERWISE, INCLUDING WITHOUT LIMITATION IMPLIED WARRANTIES OF MERCHANTABILITY AND NON-INFRINGEMENT, IMPLIED WARRANTIES ARISING FROM THE COURSE OF DEALING OR USAGE OF TRADE AND IMPLIED WARRANTIES OF SUITABILITY OR FITNESS FOR A PARTICULAR PURPOSE.

LIMITATION OF LIABILITY: THE REMEDIES PROVIDED IN THIS LIMITED WARRANTY ARE EXCLUSIVE, AND NEL HYDROGEN SHALL IN NO WAY BE LIABLE FOR INCIDENTAL OR CONSEQUENTIAL DAMAGES OF ANY KIND WHATSOEVER INCLUDING WITHOUT LIMITATION LOSS OF USE, REVENUE OR PROFIT.

Hydrogen Refueling Station Equipment

350 Bar Hydrogen Fueling Equipment Budgetary Proposal

Submitted To: **Dillon Consulting Limited**
Attention: Sean Russell

Submitted By: **Powertech Labs Inc.**
12388 88th Ave.
Surrey, BC, Canada V3W 7R7
2021-04-19

Powertech Proposal #: 22-10552 Rev. 1

Prepared By:

Stephanie Mills

Stephanie Mills, P.Eng
Process Engineer, Hydrogen Infrastructure
Advanced Transportation
Phone: 604-590-7421
Email: leanne.sharpe@powertechlabs.com

Reviewed By:

Angela Das

Angela Das, P.Eng.
Director
Advanced Transportation
Phone: 604-590-7467
Email: Angela.das@powertechlabs.com

Contents

1. COPYRIGHT/CONFIDENTIALITY..... 3

2. EXECUTIVE SUMMARY..... 4

3. POWERTECH BACKGROUND 5

4. SCOPE..... 6

 4.1 STATION FEATURES.....6

 4.2 INCLUSIONS / EXCLUSIONS6

5. PROPOSED DESIGN 8

 5.1 EQUIPMENT SYSTEM DESIGN AND SPECIFICATIONS8

 5.2 STATION SAFETY9

 5.3 CODES AND STANDARDS.....10

 5.4 REMOTE MONITORING.....11

 5.5 FACTORY ACCEPTANCE TESTING11

 5.6 SITE ACCEPTANCE TESTING11

 5.7 DOCUMENTATION11

 5.8 OPERATING, MAINTENANCE AND TRAINING12

6. PROJECT SCHEDULE AND DELIVERY 13

7. PRICING AND INVOICING..... 14

 7.1 PRICE.....14

 7.2 PAYMENT SCHEDULE.....14

 7.3 VALIDITY14

 7.4 WARRANTY.....14

8. ASSUMPTIONS..... 15

9. ACCEPTANCE 16

10. CONCLUSIONS 17

11. REVISION HISTORY 18

APPENDICES..... 19

APPENDIX A: THE POWERTECH ADVANTAGE 20

POWERTECH QUALIFICATIONS21

TECHNICAL ADVANTAGES.....21

TECHNICAL INNOVATIONS21

HYDROGEN ACTIVITIES.....22

ADVANTAGES OF POWERTECH FUELING STATION DESIGN24

APPENDIX B: EXAMPLES OF RELEVANT PROJECTS..... 25

1. Copyright/Confidentiality

This confidential document has been prepared for use by Dillon Consulting Limited and specifically relates to the supply of a 350 bar bus hydrogen fueling station for installation in Canada. The recipient is not entitled to make use of any information contained in the document for any other purpose other than as intended, nor disclose its contents to any third party, without the specific written permission of Powertech.

2. Executive Summary

Powertech Labs Inc. is pleased to submit this budgetary proposal to Dillon Consulting Limited for the supply of one 350 bar hydrogen bus fueling station to be installed in Canada.

The station will include the following:

- ❖ Equipment capable of dispensing up to 400 kg/day.
- ❖ Hydrogen Compressor(s) (30 bar to 450 bar).
- ❖ Buffer tank with 30 bar pressure rating.
- ❖ 450 bar hydrogen storage tanks, 500 kg capacity.
- ❖ Single-nozzle standalone dispenser, including user interface, for 350 bar heavy duty fueling
- ❖ PLC control system (non-SIL rated), capable of remote access for monitoring, clearing of faults, and data file downloads.
- ❖ Documentation, including manufacturer's manuals where applicable, drawing package and operations manuals in pdf format.

Powertech has a long and demonstrated capability of design and delivery of hydrogen fueling stations in the range of 350 bar to 700 bar across North America.

3. Powertech Background

Powertech supports the reduction of carbon emissions from transportation systems through its activities in testing and development of hydrogen systems. We are a global leader in design verification, performance, and certification testing of high-pressure gas components and systems, primarily for the hydrogen and compressed natural gas industries and offer standardized, customized, and destructive testing services to component manufacturers, Tier 1 & 2 integrators and suppliers, automotive OEMs, regulatory authorities, and aerospace companies around the world. Powertech is also a technical leader in the design, construction, and operation of compressed hydrogen fueling infrastructure solutions – these include stationary, semi-permanent, and mobile refueling stations, light-weight tube trailers, and station testing and certification equipment. With over 20 years of experience in this space, Powertech is credited with the world’s first 700 bar hydrogen fast fill fueling station in 2002. Further details on Powertech are given in Appendices A and B.

Powertech is a wholly owned subsidiary of BC Hydro, a crown corporation of the Government of British Columbia. Powertech’s quality management and environmental management systems comply with ISO 9001 and ISO 14001 respectively.

4. Scope

This proposal applies to the design, fabrication and supply of one hydrogen fueling station for the fueling of 350 bar buses.

4.1 Station Features

The station will include the following capabilities and features:

- ❖ PLC control system, capable of remote access for monitoring, fault clearing, and data file downloads (internet connection required).
- ❖ Flow measurement, accurate to $\pm 5\%$ at 1 kg hydrogen dispensed.
- ❖ Documentation, including manufacturers' manuals where applicable, drawing package and operations manuals in PDF format.

The station will include:

- ❖ One stand-alone, single-nozzle dispenser, including user interface.
- ❖ Hydrogen cooling system to allow for H35 T20 pre-cooled fills (cooling requirements to be confirmed).
- ❖ Dispense up to 400 kg of hydrogen per day at 30 bar inlet and 450 bar discharge pressure
- ❖ 500 kg of total hydrogen storage at 450 bar.
- ❖ Hydrogen buffer tank rated to 30 bar.
- ❖ Equipment CRNs.

4.2 Inclusions / Exclusions

The following are included in the price:

- ❖ Factory Acceptance Test (FAT) at Powertech with hydrogen on equipment prior to shipping.
- ❖ Site Acceptance Test (SAT) (time on site only – travel time and expenses will be extra).
- ❖ On-site operations and maintenance training (15 hours over two days – additional time will be extra).
- ❖ Warranty as specified in Section 7.4.

The following items are not included in this quotation:

- ❖ Heavy-duty fueling protocol development (bus manufacturer should provide details for safe fueling).
- ❖ Point of Sale (POS) system (hardware and software license).
- ❖ Equipment delivery to site.
- ❖ Site design and preparation of foundation, utilities, grounding circuit, safety barriers, canopy and fencing – if applicable.
- ❖ Building permits, environmental and other approvals and on-site inspections.
- ❖ Site installation of equipment.

- ❖ Site purging of equipment.
- ❖ On-site hydrogen and coolant line connections.
- ❖ Onsite electrical connections and terminations.
- ❖ Vent stack design and installation on site.
- ❖ Back-up (tube trailer) hydrogen supply.
- ❖ Test tank and/or vehicle for test fills during Site Acceptance Testing.
- ❖ Operational permits and other regulatory approvals.
- ❖ Gas sampling, hydrogen quality test or other tests on completion.
- ❖ Operation of the system.
- ❖ Remote support.
- ❖ Service and maintenance program.
- ❖ Site inspections or site troubleshooting after SAT.
- ❖ Conformance to IEC 61511.
- ❖ Third Party (i.e. Intertek) Certification (optional pricing included).

Note: Powertech offers some of these services for an additional fee.

5. Proposed Design

5.1 Equipment System Design and Specifications

This proposal applies to the design, fabrication and supply of one 350 bar hydrogen refueling station for the filling of buses, assuming a hydrogen supply pressure of 30 bar.

Compressor controls and vehicle fueling will be automated using a PLC. Remote monitoring capability will allow viewing of the station's status and performance and will provide access to historical (logged) data. All relevant process conditions and setpoints will be viewable in real time via the touchscreen HMI interface. An internet connection is required for all remote access functionality.

Custom-built enclosures will be provided to house all compressing and controls equipment. Exact container layout, size, quantity and design would be confirmed when a detailed proposal is submitted however the estimated size of the container is 30 feet long by 9 feet wide by 9 feet high. The station design will allow it to be located outdoors. Figure 1 gives an example of Powertech's containerized station that was built for Toyota Canada and is located in Quebec, Canada. Storage and refrigeration systems will be provided as separate modules that will need to be installed on site.



Figure 1. Powertech's Containerized 700 bar dispenser in Quebec City, Quebec.

This design will provide up to 400 kg of hydrogen per day. One or more compressors will be used to compress hydrogen from the hydrogen buffer tank to the 450 bar storage banks. The dispenser will use the storage banks to supply hydrogen for fueling buses.

The 450 bar storage tanks will be plumbed in separate high, medium, and low banks with a total capacity of approximately 500 kg. The approximate dimensions will be 12' by 24'.

One stand-alone 350 bar dispensers designed by Powertech will be provided. The standard dispenser designed by Powertech includes a flow meter, flow controller, and the hose, breakaway and nozzle assembly. A single display screen located on the dispenser will provide fill details. The dispenser will

include a heavy-duty fueling nozzle. The approximate dimensions of the dispenser are approximately 4' x 2' x 9'.



Figure 2. Rendering of Powertech dispenser.

5.2 Station Safety

The following safety features are integrated into the station design:

- ❖ The hydrogen station will meet the applicable codes, standards and regulations that govern hydrogen fueling stations.
- ❖ Hazardous area drawings will be provided.
- ❖ All electrical equipment contained within the hazardous area container will have a Class 1 Div 2 electrical classification.
- ❖ A HAZOP will be completed, and the station design will be reviewed by a team of certified Functional Safety Engineers (TÜV Rheinland).
- ❖ A risk assessment will be completed.

- ❖ The Emergency Shutdown System will close all air valves and disable the system operation if any safety systems are activated (e.g. fire detection, hydrogen detection).
- ❖ All warnings and alarms will be communicated via automated emails.
- ❖ The hazardous area enclosures will be built with 2-hour fire rating on external walls.
- ❖ A detailed description of the safety systems will be provided.

The following safety system components will be included with the station:

- ❖ All station containment will include continuous monitoring for hydrogen gas leaks and fires.
- ❖ Pressure sensors will be installed throughout the system as required to ensure that the station is functioning correctly.
- ❖ Temperature sensors will be situated in key locations to ensure that the station is functioning correctly.
- ❖ Emergency Shutdown (ESD) buttons will be located in key areas and, when activated, will isolate all hydrogen flows and disable system operation.
- ❖ Each hydrogen gas detector will provide a warning at a hydrogen gas concentration of 15% of the lower flammability limit (LFL) of hydrogen and a system alarm and shutdown at a hydrogen gas concentration of 25 % LFL.
- ❖ External alarm lights and audible alarms will be included.
- ❖ Pressure relief valves will be installed on hydrogen storage cylinders and at key locations throughout the system to ensure that all equipment is effectively protected.

5.3 Codes and Standards

The equipment will be designed to comply with the following codes and standards, where applicable:

- ❖ CGA S-1-3 – Pressure Relief Device Standards
- ❖ NFPA 2 – Hydrogen Technologies Code
- ❖ NFPA 70 – National Electrical Code
- ❖ IEC 60079 - Explosive atmospheres
- ❖ CGA 5.4 – Standard for Hydrogen Piping System at User Locations
- ❖ SAE J2600 – Compressed Hydrogen Surface Vehicle Fueling Connection Devices
- ❖ SAE J2601-1 – Fueling Protocols for Light Duty Gaseous Hydrogen Surface Vehicles
- ❖ SAE J2601-2 – Fueling Protocols for Gaseous Hydrogen Powered Heavy Duty Vehicles
- ❖ SAE J2799 – Hydrogen Surface Vehicle to Station Communications Hardware and Software
- ❖ SAE J2719 – Hydrogen Fuel Quality for Fuel Cell Vehicles
- ❖ ISO/TS 19880-1 – Gaseous Hydrogen – Fueling Stations – General Requirements
- ❖ ASME B31.3 – Process Piping
- ❖ ASME B31.12 – Hydrogen Piping and Pipelines
- ❖ API 520 – Sizing, Selection, and Installation of Pressure-Relieving Devices

5.4 Remote Monitoring

Remote station access will include the following features:

- ❖ Access to all HMI displays, including diagnostic displays.
- ❖ Automated email alerts to the station operator/entity in charge of maintenance, regarding system failures and service requirements.
- ❖ Access to logged fueling and system data via the station database.

Unauthorized access to the station will be prevented through the use of a password-protected VPN connection. Additional security will be provided via the use of passwords on the HMI displays, to prevent unauthorized modification of key setpoints or bypassing of key alarms. This remote station access functionality will require an internet connection.

5.5 Factory Acceptance Testing

Commissioning and testing of the station equipment will be completed at Powertech's facility prior to shipping to site, including all software, mechanical, and electrical pre-start-up checks, pressure testing (with nitrogen) and leak testing (with hydrogen), and confirmation of all safety-related shutdowns.

5.6 Site Acceptance Testing

Site acceptance testing is not included in this proposal. Powertech can provide remote support for this for an additional cost.

5.7 Documentation

Powertech will provide the following documents:

- ❖ Project schedule including major equipment delivery times.
- ❖ Equipment Specification Sheet.
- ❖ Process Flow Diagram.
- ❖ P&ID Drawings.
- ❖ Equipment General Arrangement Drawing.
- ❖ Electrical and controls drawings required for site installation.
- ❖ Electrical load list.
- ❖ Factory Acceptance Test report.
- ❖ Record drawings, including lifting points and equipment weight.
- ❖ Spare parts list.
- ❖ Operations and Maintenance Manual, including maintenance schedule.

Bi-weekly progress updates will be provided to the customer, either via teleconference during business hours or email.

5.8 Operating, Maintenance and Training

An operations and maintenance manual will be supplied for the station, including separate compressor manuals. The operations and maintenance manual will include detailed information on the station, including component specifications, HMI display screenshots with detailed guidance on HMI use, a troubleshooting guide to assist with unplanned maintenance, and an emergency procedures guide.

6. Project Schedule and Delivery

A detailed project schedule will be provided within 4 weeks of receipt of order.

The ready-to-ship date for the equipment will be approximately 14-16 months after receipt of signed equipment purchase order. Note that delivery time may be affected by shop availability at the time of order.

7. Pricing and Invoicing

7.1 Price

The budgetary price for the proposed equipment is as follows:

350 bar Hydrogen Bus Fueling Station:	\$2,950,000 CDN
Optional ETL approval:	\$ 80,000 CDN
Additional 500kg of 450bar H2 Storage:	\$ 745,000 CDN

Notes:

- ❖ Price is budgetary only and is subject to successful negotiation of Terms and Conditions.
- ❖ Installation and any additional and/or out-of-scope services will be provided on either a time and materials basis, or a fixed price basis. The pricing structure will be determined by the type of additional work.
- ❖ All prices are quoted in CDN dollars and do not include any applicable taxes.
- ❖ Additional storage price includes all required valves and instrumentation installed. Site installation and shipping is not included.

7.2 Payment Schedule

Payment schedule will be determined with firm price quotation.

7.3 Validity

Please see Section 9.

7.4 Warranty

Refer to the Equipment Sales Agreement for warranty information.

8. Assumptions

This proposal is prepared with the following assumptions:

- ❖ **Customer Obligations.** Customer will provide timely information on specific site requirements that would affect the design of the fueling station. The customer is to provide an engineered pad for the container foundation, and an electrical connection to provide 3 phase power. The equipment electrical requirement is approximately 300 kW.
- ❖ **Delays.** If the project is delayed, disrupted, or terminated early at no fault of Powertech, then the portion of the project already completed will be invoiced (including engineering time). Early termination of the project once work has been initiated, and due to no fault of Powertech, will be subject to costs incurred for project initiation, set-up, work completed to date, materials and equipment purchased to date and other miscellaneous costs, all of which shall become immediately payable.
- ❖ **Schedule Confirmation.** The engineering and fabrication schedule cannot be guaranteed until a purchase order is received.
- ❖ **Witness.** Additional charges may apply if the customer and/or a representative are/is required to witness the factory acceptance testing. Witnessing is subject to availability and the witness is responsible for supplying the appropriate personal protection equipment when on site.
- ❖ **Credit Check.** The proposal submitted is subject to credit approval by Powertech or 100% prepayment will be required.

9. Acceptance

This proposal is intended to provide the recipient with a detailed understanding of Powertech's capabilities and experience and its product design. In its current form it is not an offer, and is not open for acceptance. On request, pricing can be firmed up and a firm proposal/offer provided.

UPON POWERTECH PROVIDING A FIRM PROPOSAL, AND NOT BEFORE, A PURCHASE ORDER OR EQUIVALENT REFERENCING SUCH PROPOSAL, WHETHER BY PROPOSAL NUMBER (PREFERRED) OR BY WORK DESCRIPTION, WILL CONSTITUTE ACCEPTANCE. NO WORK WILL COMMENCE WITHOUT A VALID AND COMPLETE PURCHASE ORDER. UNLESS OTHERWISE AGREED IN WRITING BY BOTH PARTIES, SUBSEQUENT ACCEPTANCE OF A FIRM PROPOSAL SHALL BE DEEMED INCLUSIVE OF SUCH TERMS AND CONDITIONS NEGOTIATED BETWEEN THE PARTIES. NO ALTERNATE TERMS AND CONDITIONS ASSOCIATED WITH, OR PRINTED ON, A PURCHASE ORDER ISSUED BY THE CUSTOMER WILL APPLY.

10. Conclusions

Powertech appreciates the opportunity to provide budgetary pricing for this project. Accordingly, we have provided a proposal that includes the following:

- ❖ Supply of a 350 bar hydrogen bus fueling station for installation in Canada.
- ❖ PLC control system and user interface for dispenser control.
- ❖ Factory acceptance testing of the station, to take place at the Powertech Labs facility.
- ❖ Site acceptance testing and training onsite in Canada.
- ❖ Relevant documentation and Operating & Maintenance manuals for the station.

We look forward to the opportunity to work with Dillon Consulting on this project.

11. Revision History

Revision Date	Description of Change
2021-04-19	New document.

Appendices

The following appendices are attached.

Appendix A: The Powertech Advantage

Appendix B: Examples of Relevant Projects

Appendix A: The Powertech Advantage



Powertech Labs Inc. is one of the largest testing and research laboratories in North America, situated in beautiful British Columbia, Canada. Our 11-acre facility offers 15 different testing labs for a one-stop-shop approach to managing utility generation, transmission and distribution power systems.

Powertech is home to a broad range of scientists, engineers, and technical specialists, with

capabilities in electrical testing, cable condition assessment, mechanical and materials engineering, software technologies, power system studies, chemical analysis, gas systems engineering, and smart utility services. These skilled researchers have decades of collective and real-world experience and often work in cross-departmental teams to investigate, diagnose and solve complex problems.

As an independent, third-party testing facility, we adhere to the highest laboratory (ISO 17025), quality (ISO 9001) and environmental (ISO 14001) management standards. Many of our scientists and engineers chair or participate in various standards committees within their fields of expertise. Additionally we have the capabilities to derive and develop non-standard testing methods and setups required to test product prototypes and perform forensic analysis.

Outside of the utilities industry, Powertech provides routine testing capabilities, product development, research and consulting services to support an array of industrial-type operations, electrical equipment manufacturers and automotive original equipment manufacturers.

Powertech's Hydrogen Technology Centre (shown below) is a hydrogen-safe test and assembly facility equipped to handle light duty and heavy duty fuel cell vehicle testing and maintenance. The fabrication, commissioning and testing of hydrogen fueling systems are also performed in this facility.



Powertech's engineers, scientists and technologists have extensive experience and are recognized as industry leaders within their respective fields. Working together, our experts help design, test and demonstrate new technologies before they are brought to market, as well as assess and improve the performance, efficiency, safety, reliability and impact of existing technologies.

Powertech has over 30 years of experience in the use of compressed natural gas and compressed hydrogen as an automotive fuel. Powertech has the in-house expertise to design, build and test hydrogen fueling stations.

Powertech's Hydrogen Technology Centre in Surrey, B.C.

POWERTECH QUALIFICATIONS

Powertech is the premier test facility in the world for CNG and high pressure compressed hydrogen vehicle and filling station components. The company offers independent equipment testing and certification services to national and international standards, materials performance assessment, failure analysis, and D/P FMEA for vehicle OEMs. Powertech's quality management system is registered to ISO 9001 which covers all aspects of Powertech's products and services. Powertech is also an accredited laboratory in the Standards Council of Canada Program for the Accreditation of Laboratories.

All Powertech engineers are registered as Professional Engineers with the Association of Professional Engineers and Geoscientists of British Columbia. Powertech technologists are registered as Applied Science Technologists with the Applied Science Technologists and Technicians of British Columbia.

TECHNICAL ADVANTAGES

Leading authority on high pressure composite pressure vessels used for vehicles, stationary and transport applications

- ◇ Powertech has deployed composite tanks in fueling station applications since 2001

Leading authority on high pressure hydrogen codes and standards

- ◇ Powertech advises regulatory authorities (Transport Canada, US DOT/NHTSA, Japan KHK/MITI, Korea Gas Safety, etc.)
- ◇ Powertech has established working relationships with local AHJs (CalOSHA, BC Safety Authority, Technical Safety and Standards Association, etc.)

Leading authority on the testing and design qualification of high pressure hydrogen vehicle and fueling station hardware

- ◇ Powertech testing expertise and knowledge base is incorporated into hydrogen fueling station designs for maximum performance, reliability and safety

Leading authority on the safety of hydrogen storage systems through extensive testing, and experimental programs on specific safety issues

- ◇ Powertech conducts testing on fire, ignition, hydrogen releases, severe impact and abuse, environmental effects, leakage and permeation, etc.

TECHNICAL INNOVATIONS

- ❖ ***World's first*** application of lightweight carbon fiber tanks for the transport of compressed hydrogen – Michelin Bibendum, November 2001 (Los Angeles to Las Vegas)
- ❖ ***World's first*** use of carbon fiber ground storage tanks at a hydrogen fueling station – Powertech Labs, 2001
- ❖ ***World's first*** 700 bar fast fill hydrogen fueling station, November 2002
- ❖ ***World's first*** high pressure hydrogen gas cycle testing facility for 350 and 700 bar fuel systems
- ❖ ***World's only*** fast fill hydrogen fueling test facility to facilitate the development of 700 bar fuel systems, fueling stations and applicable standards (e.g. SAE J2601, SAE J2799) – Powertech Labs, 2006
- ❖ ***World's first*** high pressure hydrogen pre-cooler design validated to SAE J2601, Powertech Labs, 2008
- ❖ ***World's first*** modular high pressure hydrogen fueling station design – Victoria, B.C., 2005
- ❖ 700 bar mobile fueller to support Toyota's Alaska to Vancouver road rally, 2007

- ❖ 700 bar mobile fueller to support the Hydrogen Road Tour from Chula Vista to Vancouver, June 2009
- ❖ Providing design qualification testing to the only two known manufacturers of 1,000 bar hydrogen ground storage tanks for hydrogen fueling stations

HYDROGEN ACTIVITIES

Following is a summary of key hydrogen programs and projects conducted by Powertech:

A. 350 bar (5,000 psi) / 700 bar (10,000 psi) Compressed Hydrogen Fueling Stations

- Since 2001, Powertech has designed and built a number of fueling stations for fast filling vehicles with compressed hydrogen, namely:
 - Surrey, B.C. Station (350 bar)
 - Pacific Spirit Station, Vancouver, B.C. (350 bar)
 - North Vancouver, B.C. Station (350 bar)
 - Victoria, B.C. Station (350/700 bar ready)
 - Bella Coola, B.C. Station (350 bar)
 - Torrance, CA Station (Toyota Motor Corporation – 700 bar)
 - Berkeley, CA Station (UC Berkeley – 350/700 bar)
 - Surrey, B.C. Station (700 bar)
 - Newport Beach, CA Station (Shell – 350/700 bar)
 - Hawaii Station (HNEI – 350 bar)
 - Front Royal, VA (Sysco - 350 bar)
 - Hawaii Station (HNEI – 700 bar)
 - Chino, CA (700 bar)
 - Riverside, CA (700 bar)
 - Vancouver, B.C. (700 bar)

Note that Powertech designed and constructed the first 700 bar hydrogen fast filling station in the world (operational November 2002) in Surrey, B.C.

B. 450 bar (6,350 psi) / 875 bar (12,690 psi) Compressed Hydrogen Transport Trailers

- Since 2001, Powertech has designed and built lightweight high volume container units for the road transport of high pressure compressed hydrogen.
- The latest trailer is 450 bar for Hawaii (HNEI)

C. Multi-Client Study, “70 MPa Hydrogen Fueling Tests to Create Data for Fueling Guidelines and Standards”

- The study was funded by Shell, BP, Nippon Oil, Iwatani, Air Liquide and US DOE/Sandia. The goal of the test program was to experimentally assess representative vehicle 70 MPa fuel systems and fueling station hardware to demonstrate their capable fueling time and state of charge (percent of full capacity) without exceeding the boundary conditions for various pre-cooled fuel inlet temperatures, fuel flow rates, ambient temperatures and initial temperatures of the storage system.
- Vehicle fuel systems under test were provided by Daimler, General Motors, Ford, Toyota and Nissan. The data is currently being used to finalize numerous hydrogen performance standards including SAE J2600, J2601, J2799 and ANSI/CSA HPRD1 and HGV4.1 – 4.10.

D. Validation Testing of 70 MPa Hydrogen Fueling Station Hardware Including Breakaways, Hoses, Nozzles and Fittings

- The project was funded by NREL with the support of the SAE. The key objective was to subject the hardware to a series of pre-qualification tests for baseline performance. Following the baseline component level testing, several “real life” tests were performed to evaluate conditions expected in service that are not necessarily covered in standards. The results of this study were shared with the SAE Fuel Cell committee and the appropriate CSA HGV committees.

E. Pre-Competitive Project, “Hydrogen 700”

- The project was funded by six major vehicle OEMs including Ford, Daimler, Toyota, Nissan, Hyundai and PSA Peugeot-Citroen and involved identifying and procuring suppliers of components suitable for 700 bar hydrogen fuel storage systems and testing the parts to ensure key operational and safety requirements could be met.
- The system components that were evaluated included tanks, valves, pressure regulators, pressure relief devices, check valves, fuel filters, fueling receptacles and fittings/tubing. A screening test program was devised to evaluate the parts using recently proposed hydrogen component standards. The data was shared among the participating automotive OEMs for the purpose of allowing them to select candidate components for their own vehicle platforms and to support their involvement in the national and international standardization process.

F. Design and Construction of a Fleet of 9 Hydrogen ICE Pickup Trucks

- The project involved the design of a 35 MPa hydrogen fuel system that could contain over 10 kg of hydrogen fuel onboard. The system was integrated into the 2005-07 model year GMC Sierra 1500HD pickup truck chassis. ETEC/Roush was contracted to convert the vehicle’s 6.0 litre V8 engine to operate with 100 percent hydrogen fuel through the use of a supercharger/intercooler and complete engine re-mapping. New spark plugs, fuel rails and hydrogen fuel injectors were sourced to complete the conversion.

G. Canadian Hydrogen Safety Program

- The Canadian Hydrogen Safety Program was developed by the Codes and Standards Working Group of the Canadian Transportation Fuel Cell Alliance and consisted of representatives from industry, academia, government and regulatory bodies. The overall program objective was to facilitate acceptance of the products, services and systems of the Canadian Hydrogen Industry by the Canadian Hydrogen Stakeholder Community to facilitate trade, ensure fair insurance policies and rates, ensure effective and efficient regulatory approval procedures and to ensure that the interests of the general public are accommodated.

H. Codes and Standards for Compressed Hydrogen Systems

◇ Powertech is involved in the development of compressed hydrogen codes and standards on the national and international level as conveners, chairs and/or technical experts. Following is a list of codes and standards that Powertech either leads or participates in:

- Technical expert for CSA NGV2/HGV2 for CNG and compressed hydrogen tanks
- Technical expert for CSA NGV3.1/HGV3.1 for CNG and compressed hydrogen vehicle components
- Technical expert for CSA Automotive Technical Committee
- Technical expert for the Canadian Hydrogen Installation Code
- Technical expert for ISO TC 197 WG 19 for gaseous hydrogen fueling station dispensers
- Technical expert for ISO TC 197 WG 24 for gaseous hydrogen fueling stations general requirements
- Technical expert for ISO TC 197 WG 15 cylinders and tube for stationary storage

- Technical expert for ANSI/CSA NGV4.1-4.10/HGV4.1-4.10 for CNG and compressed hydrogen vehicle fueling station equipment
- Technical expert for CSA PRD1/HPRD1 for CNG and compressed hydrogen pressure relief devices
- Technical expert for ASME BPV project team on hydrogen tanks

ADVANTAGES OF POWERTECH FUELING STATION DESIGN

A. Technical

- **Reliable** – Strong history of reliable fueling station operation
- **Innovative** – Station design utilizes the most leading edge technologies
 - Composite ground storage cylinders
 - Hydrogen pre-cooler
 - Custom hydrogen filling algorithm
 - Latest generation station components designed and/or tested by Powertech
- **Adaptable** – Station design adaptable to any hydrogen feedstock (e.g. from electrolyser, reformer, delivered liquid, delivered gas, etc.)
- **Compact** – Small station footprint due to efficient use of containerized design
- **Expandable** – Containerized design offers customized sizing

B. Safety

- **Codes, Standards and Regulations** – Station design will meet relevant country codes, standards and regulations
- **HAZOP** – Hazard and Operability Study conducted prior to station construction
- **Sensors** – Station containment includes hydrogen gas detection and fire detection; pressure and temperature sensors ensure safe function of the station
- **Emergency Shutdown** – Emergency shutdown system utilizes air actuated valves that isolate the system
- **Fire and Overpressure Protection** – Ground storage includes temperature activated pressure relief devices for fire protection and pressure relief valves to deplete any possible overpressure
- **Remote Monitoring** – Station warnings and alarms communicated to alert station operator for maintenance or system failure issues.

C. Commercial

- **Low Capital Cost** – Simplified design means lower initial cost
- **Low Maintenance Cost** – Station components tested at Powertech means reduced down-time due to equipment failures

Appendix B: Examples of Relevant Projects

700 bar Containerized Hydrogen Fueling Station (Quebec, Canada) - 2019

This T40 700 bar hydrogen fueling station was designed and built by Powertech in 2018. It will be installed at a retail location in Quebec, Canada. This is the first fully integrated 700 bar hydrogen fueling station in Canada.



700 Bar T40 Containerized Station

700 bar Hydrogen Fueling Station (Vancouver, Canada) - 2018

This 700 bar hydrogen fueling station was designed and built by Powertech in 2017. It is the first commercial 700 bar hydrogen fueling station in Canada. This station is located at an existing Shell site in the busy Marpole neighborhood of Vancouver. This is the first station in a planned network of six stations to be located in the Province of British Columbia.



700 Bar Vancouver Station

700 bar Mobile Hydrogen Fueling Station 2017

This 700 bar mobile hydrogen fueling station was designed and built by Powertech in 2017. It provides hydrogen fueling to a customer who requires regular relocation of the fueling station. This station is fully contained in a modified 20 foot long shipping container. The system provides the latest SAE protocol for fueling hydrogen vehicles at a T20 fill rate.

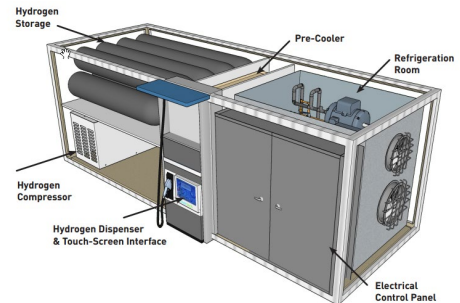

700 bar mobile fueling station

Hydrogen Station Equipment Performance Device (HyStEP) 2016

The HyStEP device was designed and built by Powertech for the U.S. Department of Energy (DOE) and H2FIRST in 2016. The hydrogen station testing device was the first of its kind in North America and ensures that public hydrogen fueling stations meet industry standards. The device tests hydrogen stations to ANSI/CSA HGV 4.3 to ensure that the station conforms to the SAE J2601 fueling protocols. The device significantly accelerates station acceptance by vehicle OEM's, as it allows for one standardized set of tests. Previously vehicle manufacturers would independently test a hydrogen station before allowing their vehicles to fuel at it.



HyStEP Device

700/350 bar Hydrogen Fueling Station (Riverside, CA) - 2016

This 700/350 bar hydrogen fueling station was designed and built by Powertech in 2015. It provides commercial Hydrogen fueling to the California market. This station is located at an existing alternative fueling station owned and operated by the City of Riverside. The system provides the latest SAE protocol for fueling hydrogen vehicles. The station will also support a local fuel cell bus manufacturer by providing hydrogen for their test drives.



350/700 bar station

700/350 bar Hydrogen Fueling Station (Chino, CA) - 2016

Based on an award from the California Energy Commission, Powertech provided the hydrogen fueling station equipment to the Chino station located at Hyundai's R&D facility. The station equipment includes a retail style dispenser, compression system and ground storage and is capable of dispensing over 100 kg/day.



350/700 bar station

700 bar Upgrade of 350 bar Station (Hawaii) - 2014

A 350 bar fueling station designed and built by Powertech in 2010 for the Hawaii National Energy institute was upgraded to also provide 700 bar fueling from a stand-alone dispenser. The upgrade involves the addition of higher pressure compression equipment, higher pressure hydrogen storage, a pre-cooler, and a stand-alone dispenser. A new control system was also necessary to optimize the operation of the station, and the fueling of vehicles.



350/700 bar station

Geothermal Project - 350 bar Hydrogen Fueling Station (Hawaii) - 2013

The 350 bar station currently involves both an electrolyzer and compression equipment installed in the same 12m container used to fill hydrogen tube trailers at 450 bar. The electrolyzer will use power from a geothermal generation source to create the hydrogen supply. A stand-alone dispenser is part of the package.



Construction of hydrogen station illustrating compressor room at one end of 12m container

Sysco Front Royal 350 bar Hydrogen Fueling Station (Virginia) - 2012

Through Praxair, Powertech has provided a 350 bar hydrogen fueling station for fueling materials handling equipment at the Sysco warehouse in Front Royal, Virginia. The station has 4 dispensers for providing up to 260 kg of hydrogen per day.



3 compressors in one 12 m container

Appendix D

Equipment Maintenance Schedules

Supplier: Nel		Maintenance intervals and estimated time budget (related to one installed unit only)																								
Designation: Hydrogen Generation		Recommended Schedules for Predictive / Preventive Maintenance																Estimated Corr. Maint		Personnel Qualification						
Product No.: M Series (All Indoor Configurations)		MTBF	MTRR	OEM	Shut Down	Online	per day	per week	per month	per quarter	per 1/2 year	per year	every 2 years	every 3 years	every 4 years	every 5 years	every 10 years	ev. x operating hrs or cycles.	total amount/year	number of activities / year	total amount/year	engineer	technician	engineer	technician	unskilled worker
Units installed:		(hrs)	(hrs)			(hrs)	(hrs)	(hrs)	(hrs)	(hrs)	(hrs)	(hrs)	(hrs)	(hrs)	(hrs)	(hrs)	(hrs)	(hrs)	(hrs)	(hrs)	(hrs)					
1	Electrolyzer					X		1											12							
	Electrolyzer																									
	Electrolyzer																									
2	RO/DI water					X				1								X	4							
	RO/DI water																									
	RO/DI water																									
3	Electrolyzer					X				2									8							
	Electrolyzer						X																			
	Electrolyzer						X																			
4	Electrolyzer					X								16					8							
	Electrolyzer						X																			
	Electrolyzer						X																			
	Electrolyzer						X																			
	Electrolyzer						X																			
	Rectifier & Rectifier Distribution						X																			
	Rectifier & Rectifier Distribution						X																			
	Transformer						X																			
	MCC						X																			
	H2 chiller						X																			
	DI water						X																			
5	RO/DI water					X													3							
	RO/DI water						X			1																
	RO/DI water						X				1															

Nel reserves the right to make changes at any time without notice, in materials, equipment, specifications and models shown in this document.

350 BAR DISPENSER SCHEUED MAINTENANCE

SCHEDULE	MAINTENANCE TASK
DAILY	<ul style="list-style-type: none"> • Inspect the dispenser and all of its components. If any damages are found, vent, disconnect AC power, and disallow further use until maintenance authority can repair the damages.
EVERY 2 WEEKS	<ul style="list-style-type: none"> • Inspect fill nozzle seals for leaks and wear • Inspect flow control or sequencing valves during filling operation • Inspect the sequencing valves for leaks • Inspect fill hoses and hose breakaway components
EVERY 6 MONTHS	<ul style="list-style-type: none"> • Change dispenser filters • Dispenser leak test <ul style="list-style-type: none"> • Visual leak inspection of pressure relief device
EVERY YEAR	<ul style="list-style-type: none"> • Tighten all electrical terminal connections and check all harness connections • Rebuild sequencing valves • Inspect fill nozzle valve, rebuild if necessary
EVERY 2 YEARS	<ul style="list-style-type: none"> • Replace fill hose
EVERY 5 YEARS	<ul style="list-style-type: none"> • Recertify pressure relief device