

1 DOOR TYPES
A7.0 1:50

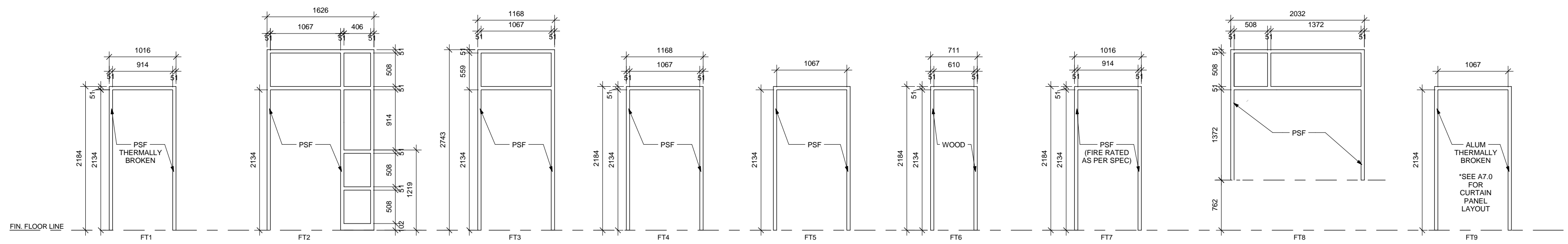

2 FRAME TYPES
A7.0 1:50

NOTES:
 * YELLOW-GREEN BACK-PAINTED GLASS SPANDREL TYPE SPA1
 * "B" LIGHT GREEN BACK-PAINTED GLASS SPANDREL TYPE SPA1
 * ALL CURTAIN WALL GLAZING TO BE TYPE EQUAL UNLESS NOTED OTHERWISE
 * ALL TRIANGULAR WINDOWS TO BE TEMPERED GLASS ON EXTERIOR TYPE EG2A. SEE A624.3 FOR LOCATION INTERIOR TEMPERED GLASS TYPE EG2B
 * "F" FROSTED GLASS APPLIED TO INTERIOR PANE
 * "C" ANODIZED ALUMINUM SPANDREL TO MATCH CURTAIN WALL FRAMING
 * ALL DOORS TO HAVE TEMPERED GLAZING (SEE DOOR SCHEDULE)
 * SEE A7.0 AND SPECIFICATION FOR ADDITIONAL SIGNAGE INFORMATION
 * FRAME DIMENSIONS TO BE DETERMINED BY MANUFACTURER

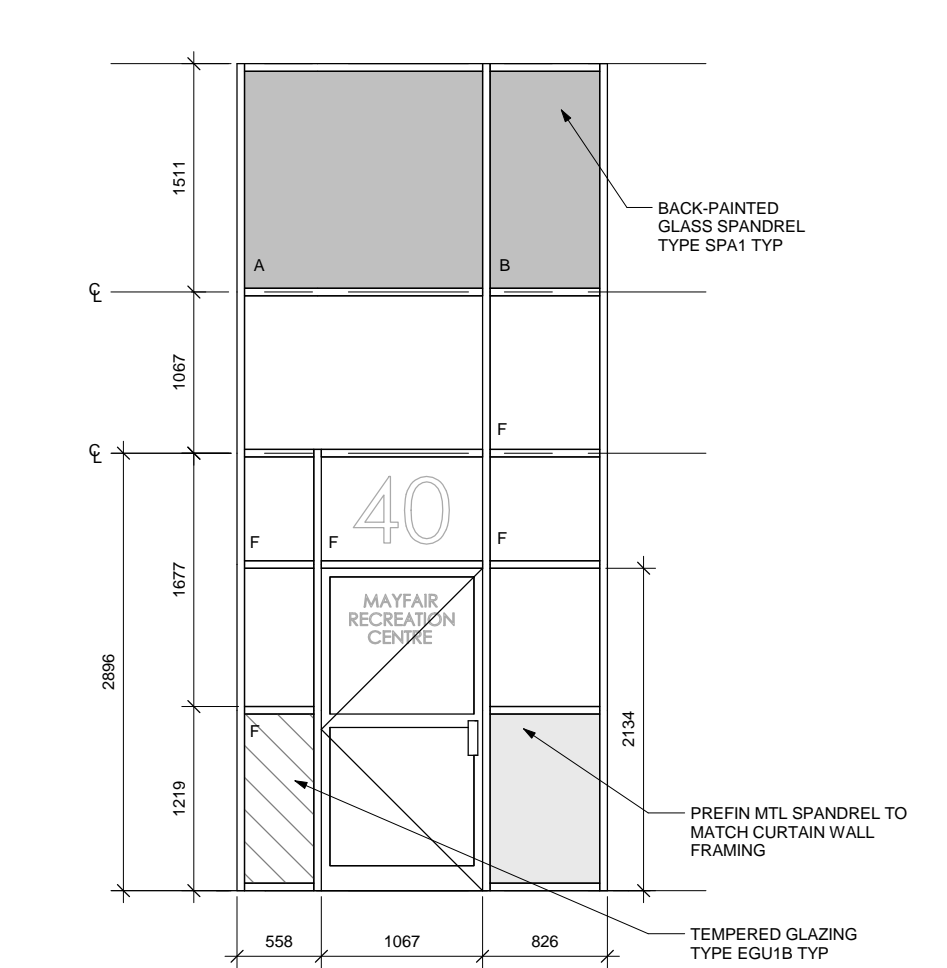

3 CURTAIN PANEL NORTH 1
1:50

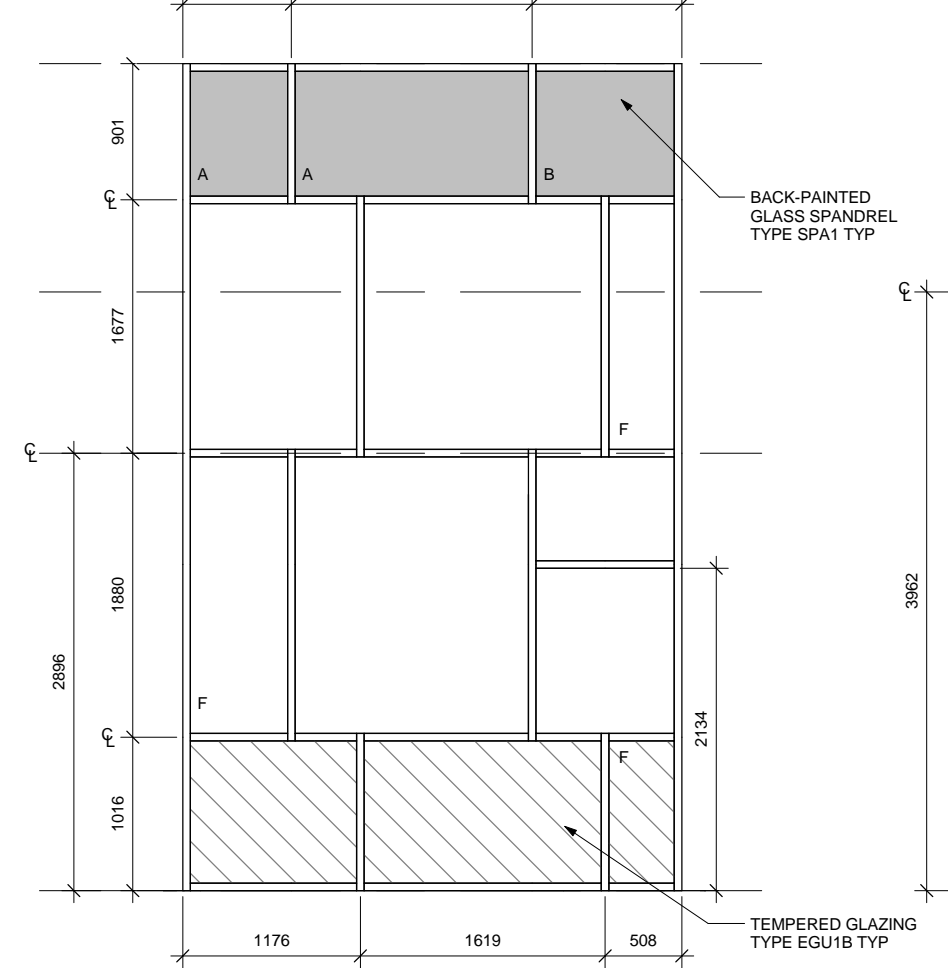

4 CURTAIN PANEL NORTH 2
1:50

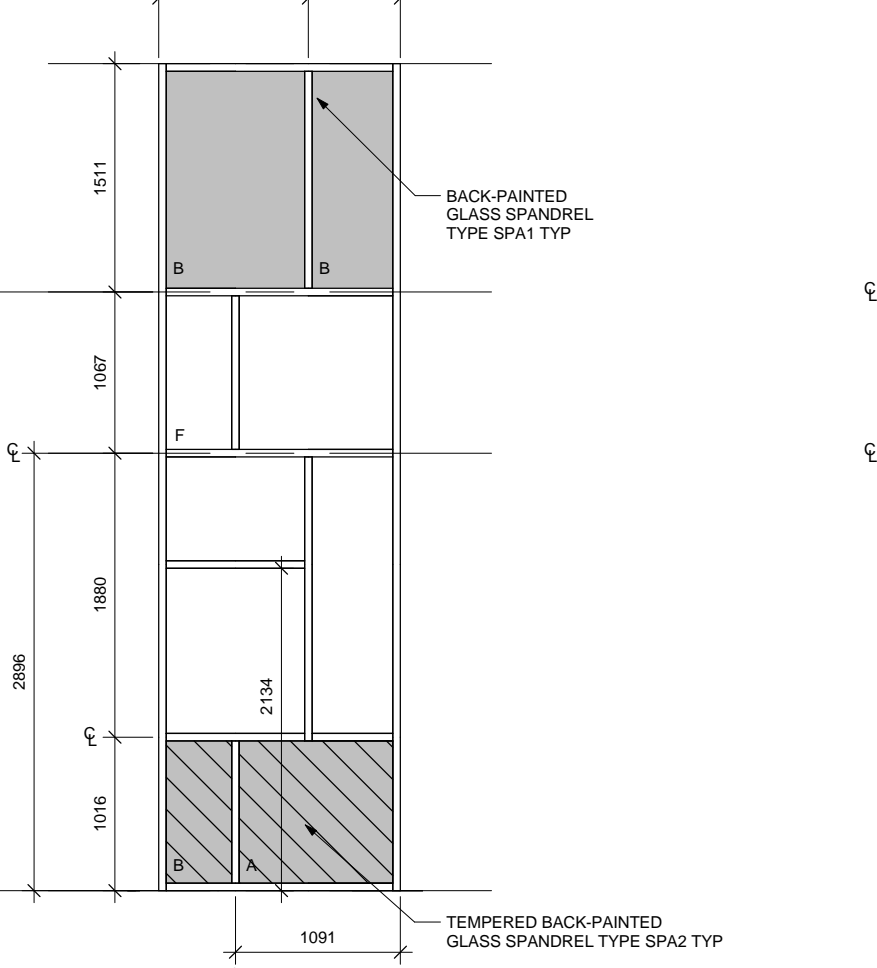

5 CURTAIN PANEL NORTH 3
1:50

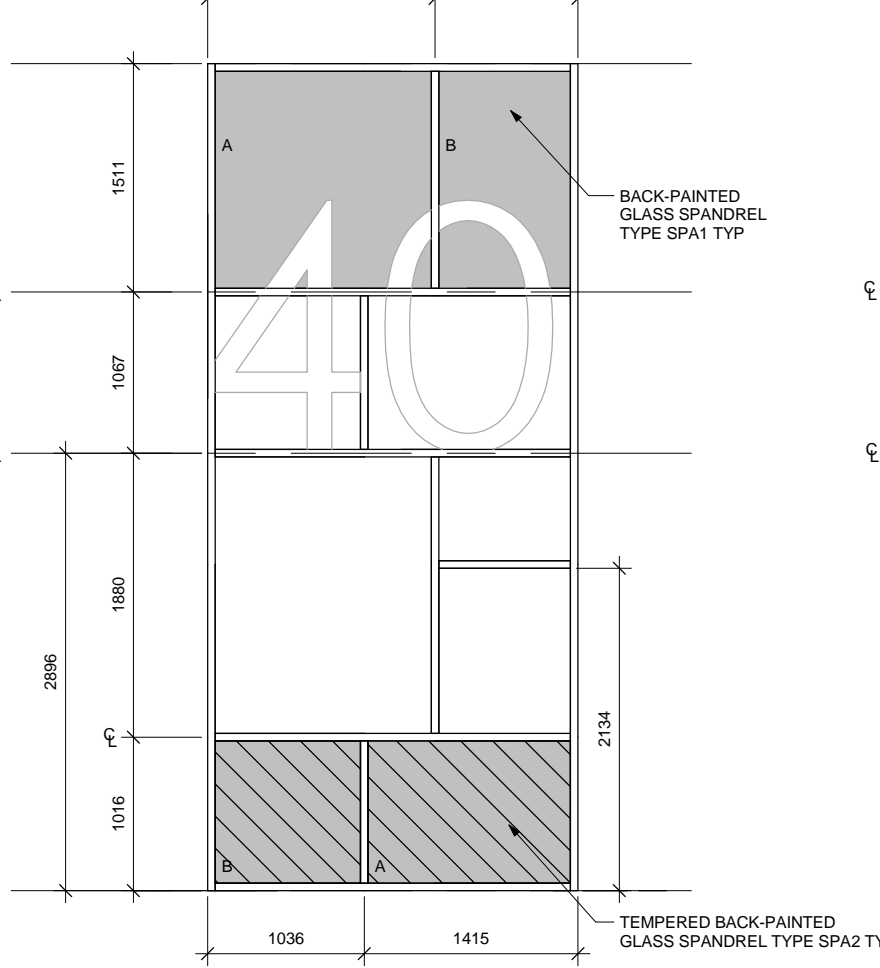

6 CURTAIN PANEL WEST
1:50

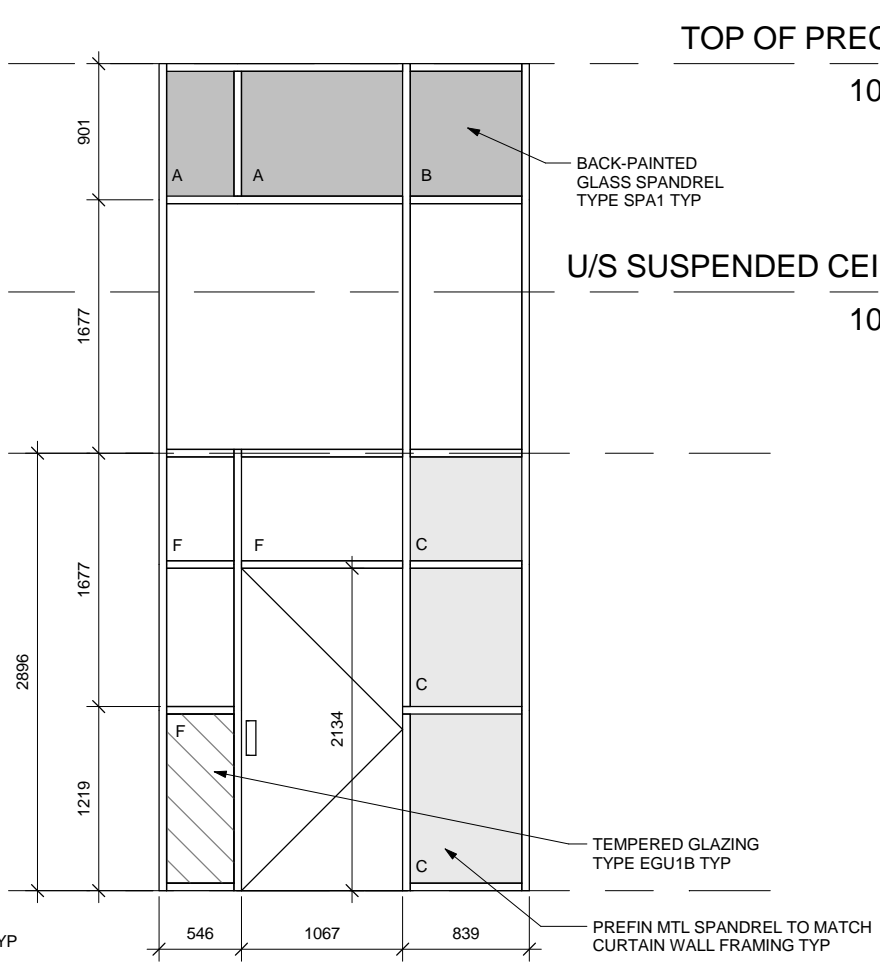

7 CURTAIN PANEL EAST
1:50

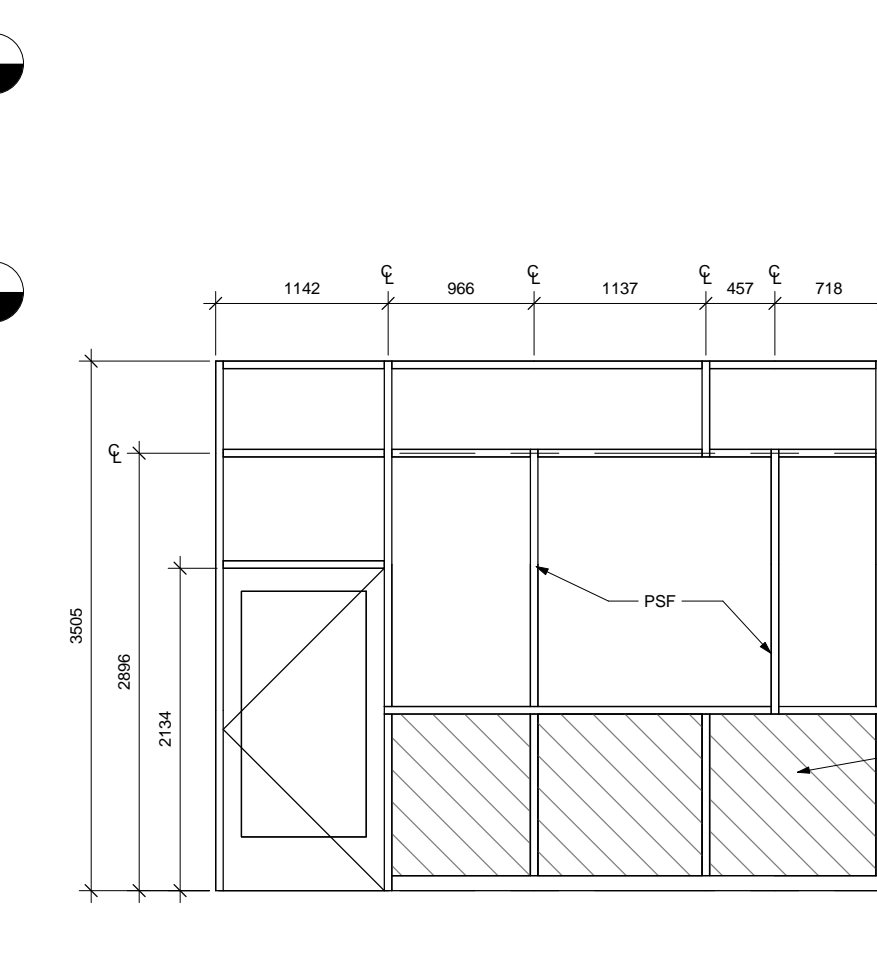

8 CURTAIN PANEL INTERIOR
1:50

DOOR SCHEDULE														
DOOR	HARDWARE GROUP	ROOM	TYPE	WIDTH	HEIGHT	THICKNESS	MATERIAL	FINISH	FIRE RATING	GLAZE	INSULATED	FRAME TYPE	DESCRIPTION	COMMENTS
D101	1	VESTIBULE	DT1	1067	2134	51	ALUM	PREFIN		TEMPERED DUAL PANE	YES	FT9	THERMALLY BROKEN	DOOR ACTUATOR
D102A	2	MULTI-PURPOSE ROOM 2	DT4	1067	2134	45	WOOD	STAINED		TEMPERED		FT2		DOOR ACTUATOR, KICK PLATE
D102B	3	MULTI-PURPOSE ROOM 2	DT6	610	2134	45	WOOD	STAINED				FT6		
D102C	3	MULTI-PURPOSE ROOM 2	DT6	610	2134	45	WOOD	STAINED				FT6		
D102D	4	MULTI-PURPOSE ROOM 2	DT4	1067	2134	45	WOOD	PREFIN		TEMPERED		FT5		DOOR ACTUATOR, KICK PLATE
D103A	5	SERVERY	DT4	1067	2134	45	WOOD	STAINED		TEMPERED		FT3		KICK PLATE
D103B	6	SERVERY	DT9	1930	1372	45	WOOD	STAINED				FT8		KICK PLATE
D104	7	JANITOR	DT7	914	2134	45	WOOD	STAINED	1 HR			FT7		KICK PLATE
D105	8	MEN UTR	DT5	914	2134	45	WOOD	STAINED				FT4		DOOR ACTUATOR, KICK PLATE
D106	8	WOMEN UTR	DT5	914	2134	45	WOOD	STAINED				FT4		DOOR ACTUATOR, KICK PLATE
D107	9	MULTI-PURPOSE ROOM 1	DT2	1067	2134	45	ALUM	PREFIN			YES	FT9	THERMALLY BROKEN	DOOR ACTUATOR
D108	10	HARVEST STORAGE	DT11	1219	2134	38	STEEL	PREFIN						OH COOLING DOOR
D109	10	STORAGE	DT11	1219	2134	38	STEEL	PREFIN						OH COOLING DOOR
D10A	11	MECHANICAL	DT3	914	2134	45	STEEL	PAINTED			YES	FT1	THERMALLY BROKEN	KICK PLATE

ROOM FINISH SCHEDULE									
NUMBER	ROOM NAME	NORTH	EAST	WEST	SOUTH	CEILING (MATERIAL - FINISH - HEIGHT)	FLOOR (MATERIAL - FINISH - BASE)	REMARKS	
101	VESTIBULE	CONC - PAINTED	GB - PAINTED	GB - PAINTED	GB - PAINTED	GB - PAINTED - 13'-0"	CONC - SKATE - RB	4 PAINT COLOURS (SEE SPECIFICATION)	
102	MULTI-PURPOSE ROOM 2	CONC - PAINTED	GB - PAINTED	GB - PAINTED	GB - PAINTED	EXPOSED - PAINTED - 14'-0"	CONC - SKATE - RB	SUSPENDED CLG W/ ACOUSTIC MATERIAL, 4 PAINT COLOURS (SEE SPECIFICATION)	
103	SERVERY	CONC - PAINTED	CONC - PAINTED	GB - PAINTED	GB - PAINTED	GB - PAINTED - 13'-0"	CONC - VS - VCB	4 PAINT COLOURS (SEE SPECIFICATION)	
104	JANITOR	GB - PAINTED	GB - PAINTED	GB - PAINTED	GB - PAINTED	EXPOSED - PAINTED - 14'-0"	CONC - SEALED - RB	FIRE RATED WALLS TO US ROOF DECK	
105	WOMEN UTR	GB - PAINTED	GB - PAINTED	GB - PAINTED	GB - PAINTED	GB - PAINTED - 9'-6"	CONC - SKATE - RB	4 PAINT COLOURS (SEE SPECIFICATION)	
106	MEN UTR	GB - PAINTED	GB - PAINTED	GB - PAINTED	GB - PAINTED	GB - PAINTED - 9'-6"	CONC - SKATE - RB	4 PAINT COLOURS (SEE SPECIFICATION)	
107	MULTI-PURPOSE ROOM 1	GB - PAINTED	CONC - PAINTED	CONC - PAINTED	CONC - PAINTED	EXPOSED - PAINTED - 14'-0"	CONC - SPORT - RB	ACOUSTIC MATERIAL APPLIED TO US ROOF DECK, 4 PAINT COLOURS (SEE SPECIFICATION)	
108	HARVEST STORAGE	GB - PAINTED	CONC - PAINTED	GB - PAINTED	GB - PAINTED	GB - PAINTED - 8'-6"	CONC - VS - VCB		
109	STORAGE	GB - PAINTED	GB - PAINTED	CONC - PAINTED	GB - PAINTED	EXPOSED - PAINTED - 8'-0"	CONC - SEALED - RB		
110	MECHANICAL	CONC - PAINTED	GB - PAINTED	CONC - PAINTED	GB - PAINTED	EXPOSED - PAINTED - 14'-0"	CONC - SEALED - RB	FIRE RATED WALLS TO US ROOF DECK	
111	ELEVATED MAINTENANCE CATWALK	N/A	GB - PAINTED	CONC - PAINTED	GB - PAINTED	EXPOSED - PAINTED - 5'-10"	CONC - SEALED - RB	FIRE RATED WALLS TO US ROOF DECK	

NOTES:
 * ALL EXPOSED STRUCTURE (METAL DECK, JOIST, BEAMS) TO BE PAINTED (SEE SPECIFICATION FOR COLOUR)
 * ALL EXPOSED ELECTRICAL SERVICE AND MECHANICAL DUCTWORK TO BE PAINTED (SEE SPECIFICATION FOR COLOUR)

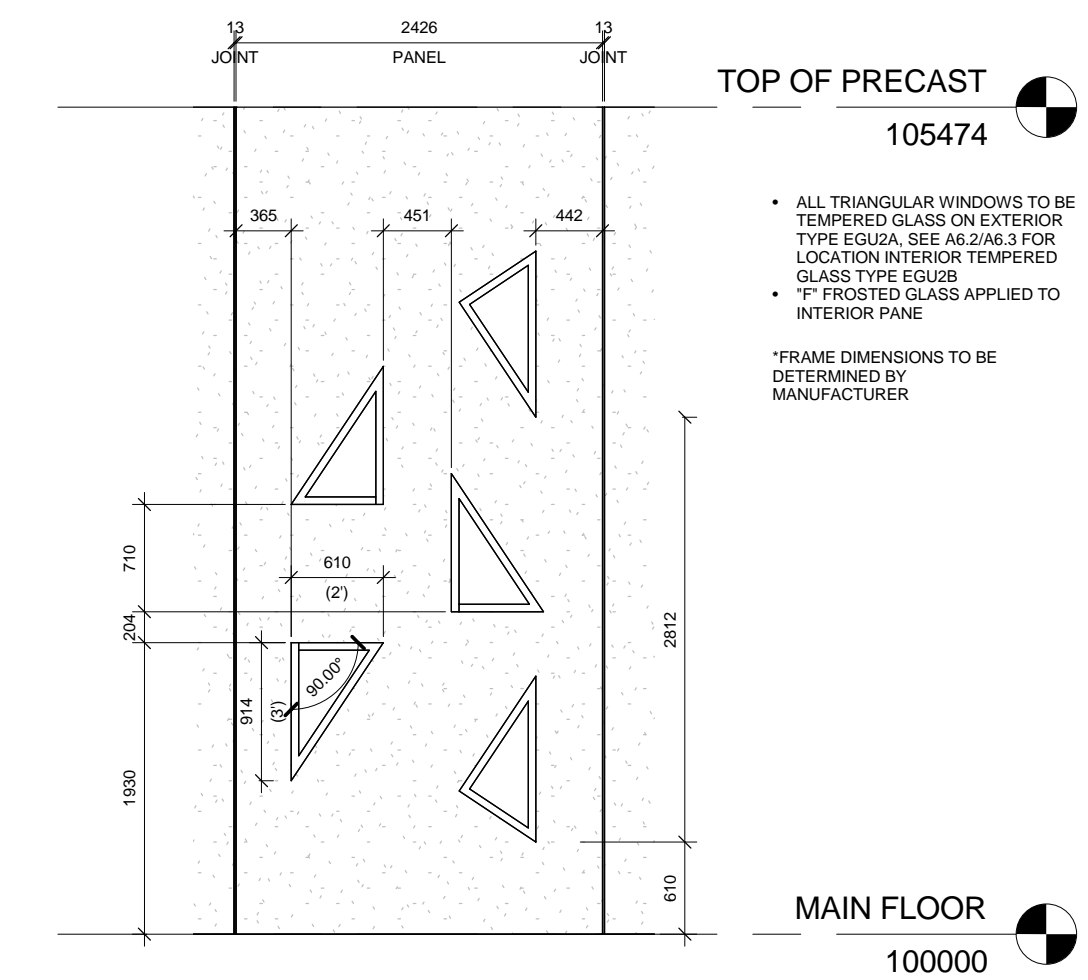

9 PANEL WINDOW LAYOUT / TYPE
1:50