

A1 SIZE 594mm x 841mm

FILE NAME: W11400100-T-020_RX.dwg Saved By: dlane

DATE: 11/06/01

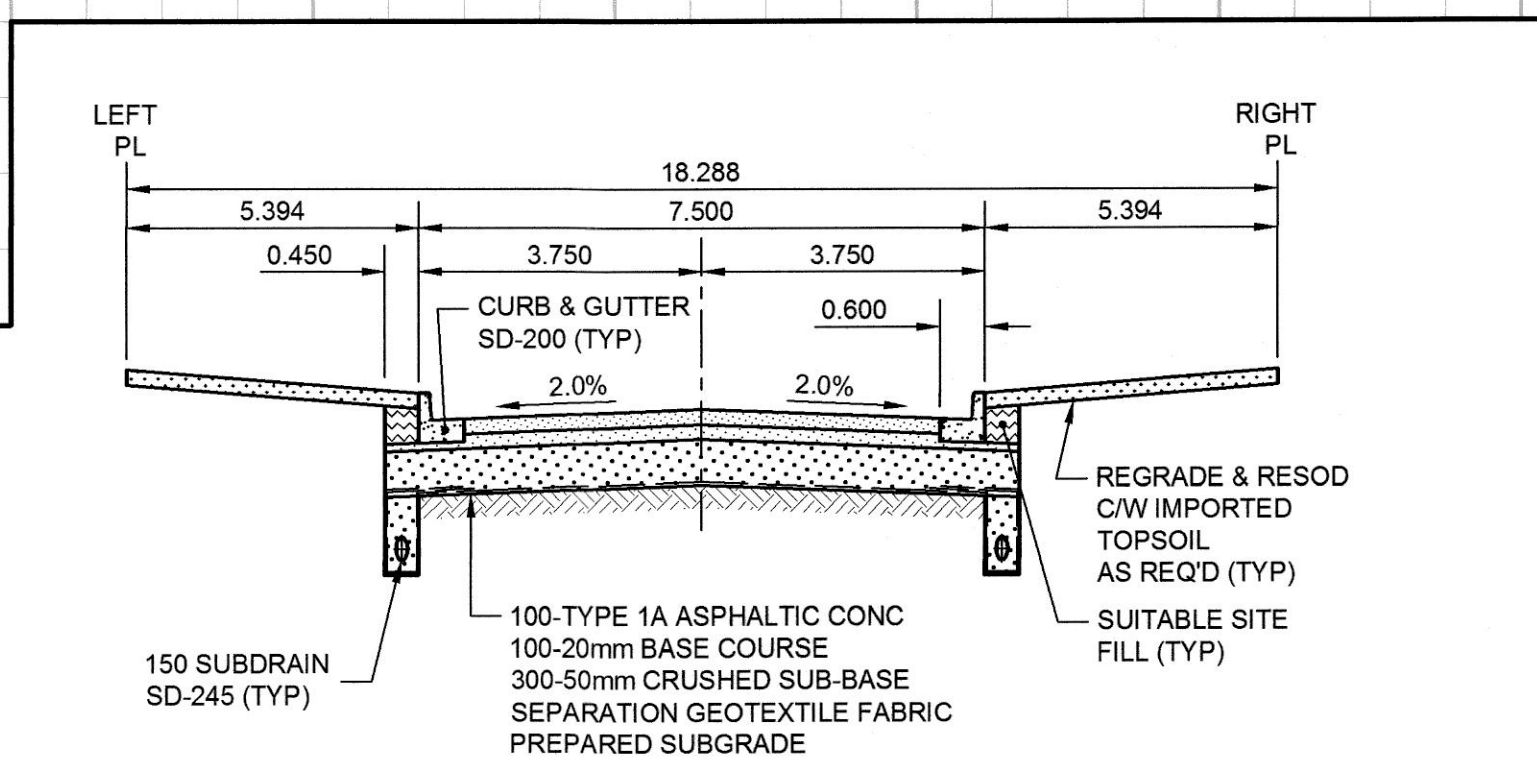
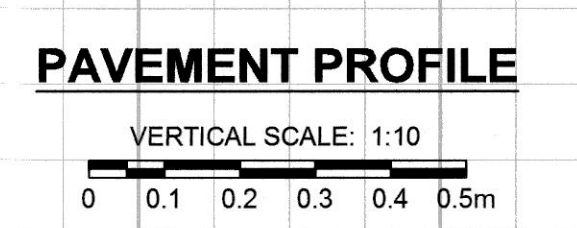
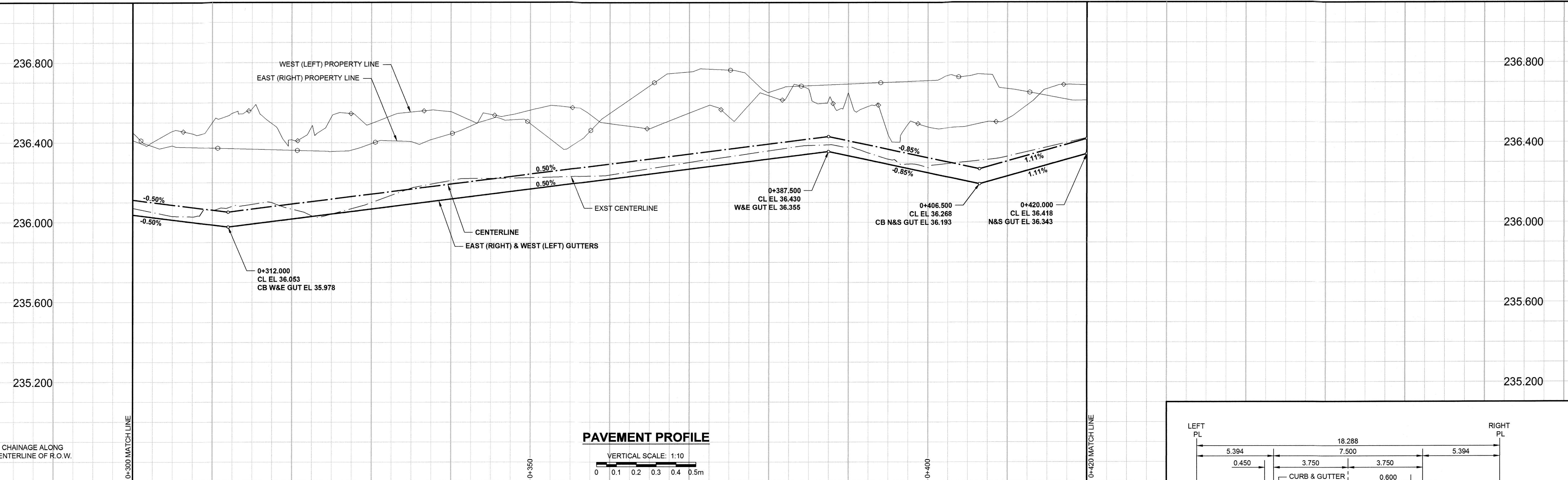

PAVT SECTION
ASPHALT PAVEMENT STRUCTURE
TYPICAL
SCALE: N.T.S

GARRIOCH AVE CENTERLINE-GEOMETRIC CONTROL POINT COORDINATES		
POINT/STATION	NORTHING	EASTING
PC 0+307.647	9854.729	9792.349
PT 0+323.355	9864.730	9782.350
PC 0+384.432	9925.807	9782.358
PT 0+400.140	9935.806	9792.359

CIRCULAR CURVE DATA				
CURVE	LENGTH	RADIUS	DELTA	TANGENT
C1	15.708	10.000	90°00'00"	10.000
C2	15.708	10.000	90°00'00"	10.000

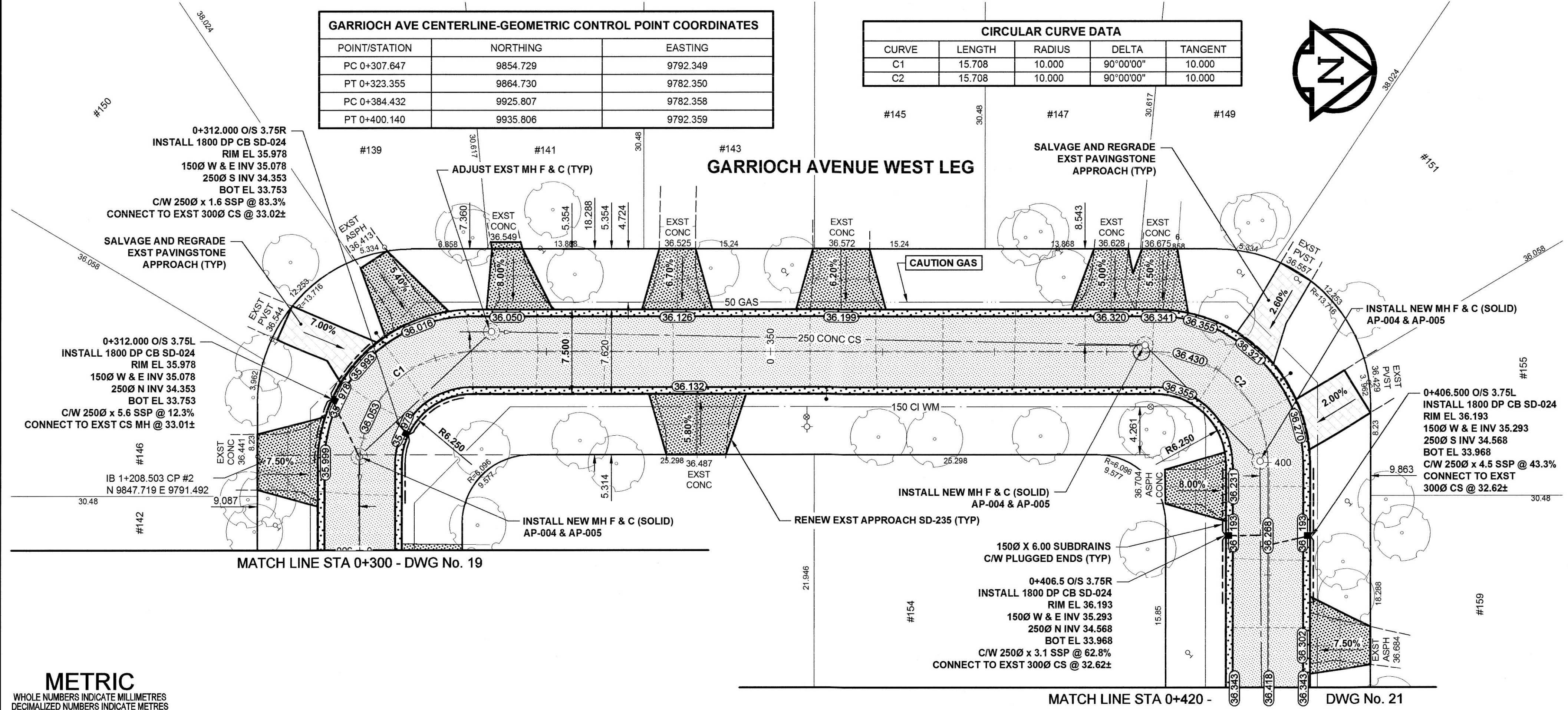
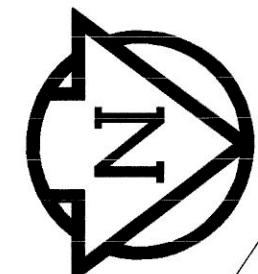

SSP CONNECTION DATA	
REFERENCE	JCT LOCATION
MH @ 0+308.330	0.00
N/CB @ 0+312.000	4.43
S/CB @ 0+312.000	0.00
MH @ 0+399.870	0.00
N/CB @ 0+406.500	7.61
S/CB @ 0+406.500	6.61

- NOTES**
- ADJUST MH AND CB RIMS TO NEW GRADES.
 - LAMP STANDARDS, HYDRO POLES, AND ANCHORS MAY REQUIRE TEMPORARY SUPPORT/REMOVAL OR REPLACEMENT AT THE CONTRACTOR'S EXPENSE.
 - CONTRACTOR SHALL REGRADE/RENEW EXST PRIVATE SIDEWALKS TO LIMITS AS SHOWN. SIDEWALKS TO BE RENEWED WITH CONCRETE UNLESS NOTED OTHERWISE.
 - CONTRACTOR SHALL TAKE PRECAUTIONARY STEPS TO PROTECT EXISTING TREES WITHIN THE LIMITS OF CONSTRUCTION FROM DAMAGE FROM CONSTRUCTION ACTIVITIES AS OUTLINED IN THE SPECIFICATIONS.
 - MODIFIED BARRIER CURB TO BE USED AT ALL INTERSECTION RADI, BACK LANE RADI AND BULLVOSES.
 - THE LOCATION OF ALL SERVICES TO BE CONFIRMED IN THE FIELD BY THE CONTRACTOR.
 - ADD 200.000m TO ABBREVIATED ELEVATIONS TO OBTAIN GEODETIC ELEVATIONS.

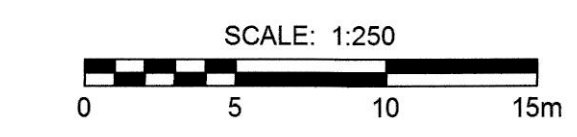

METRIC
WHOLE NUMBERS INDICATE MILLIMETRES
DECIMALIZED NUMBERS INDICATE METRES

EXISTING	LEGEND - PLAN	NEW	EXISTING	LEGEND - PLAN	NEW	EXISTING	LEGEND - PLAN	NEW
	GAS		MANHOLE		CONCRETE PAVEMENT		LOCATION APPROVED	
	MTS		CATCH BASIN / CATCH PIT		CONC SIDEWALK / MEDIAN		SUPR. U/G STRUCTURES	
	HYDRO		CURB INLET WITH BOX		ASPHALT PAVEMENT		DATE COMMITTEE	
	CATV / FIBRE OPTIC		TREE		PAVING STONE		NOTE:	
	TRAFFIC SIGNALS / PIT		TEST HOLE		GRAVEL		LOCATION OF UNDERGROUND STRUCTURES	
	LAND DRAINAGE SEWER		PROPERTY LINE		RAMP CURB		CONFIRMATION OF EXISTENCE	
	SANITARY/COMBINED SEWER		SURVEY BAR		PLANING / REMOVAL		EXACT LOCATION OF ALL SERVICES	
	SEWER SERV/DRAINAGE CONN		FENCE				INDIVIDUAL UTILITIES	
	WATERMAIN		BOC / EDGE OF PAVEMENT				PROCEEDING WITH CONSTRUCTION.	
	SUBDRAIN		ELEVATION					
	DITCH		TRAFFIC SIGN					

NO.	ISSUED FOR CONSTRUCTION	DATE	BY
0	ISSUED FOR CONSTRUCTION	11/06/01	RPB
	REVISIONS	Y/M/MDD	BY

DESIGNED BY	CHECKED BY	DATE
RPB	JGK	11/06/01
DRAWN BY	APPROVED BY	DATE
DID/DML	BWB	11/06/01

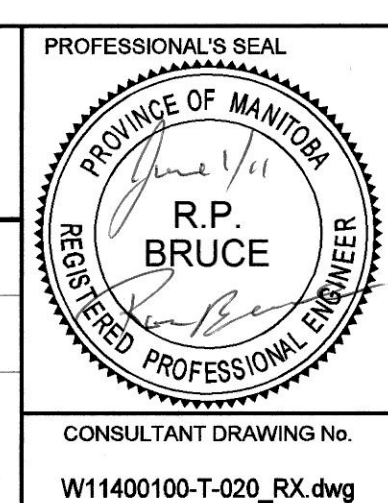

THE CITY OF WINNIPEG
PUBLIC WORKS DEPARTMENT
ENGINEERING DIVISION

2011 LOCAL STREET RENEWAL PROGRAM

GARRIOCH AVE - RECONSTRUCTION
MOUNT ROYAL RD TO MOUNT ROYAL RD
STA 0+300 TO STA 0+420

CITY DRAWING NUMBER: N/A
SHEET: 20 OF 29
DRAWING No.: 20
REV: 0

CONSULTANT DRAWING No.: W11400100-T-020_RX.dwg