

Colours

Outbound Directionals:

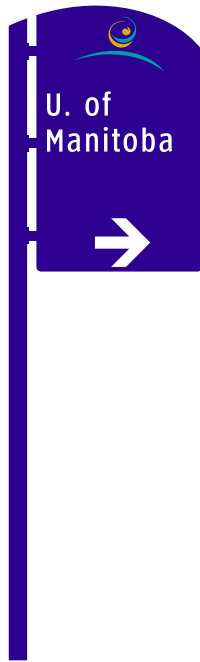

Background:
Solid Dark Blue PMS 2738



Neighborhood Band:
Aqua Blue PMS 3135



Inbound Directionals & Parking Signs:

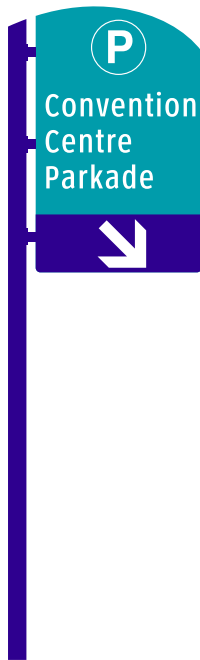
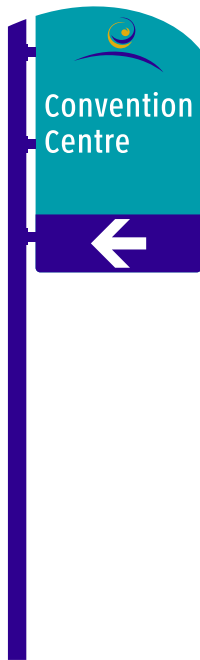

Message/Logo Area:
Aqua Blue PMS 3135



Arrow Band:
Dark Blue PMS 2738



Poles:
Dark Blue 2738



Informing Design, Inc.

4 Smithfield St. 7th Floor
Pittsburgh, PA 15222
Phone 412-261-0446

City of Winnipeg Traffic Wayfinder Sign System

"Kit of Parts" Design Details

Date: 16 August, 2004
Drawing No.: 2.01

Colours: Use of French

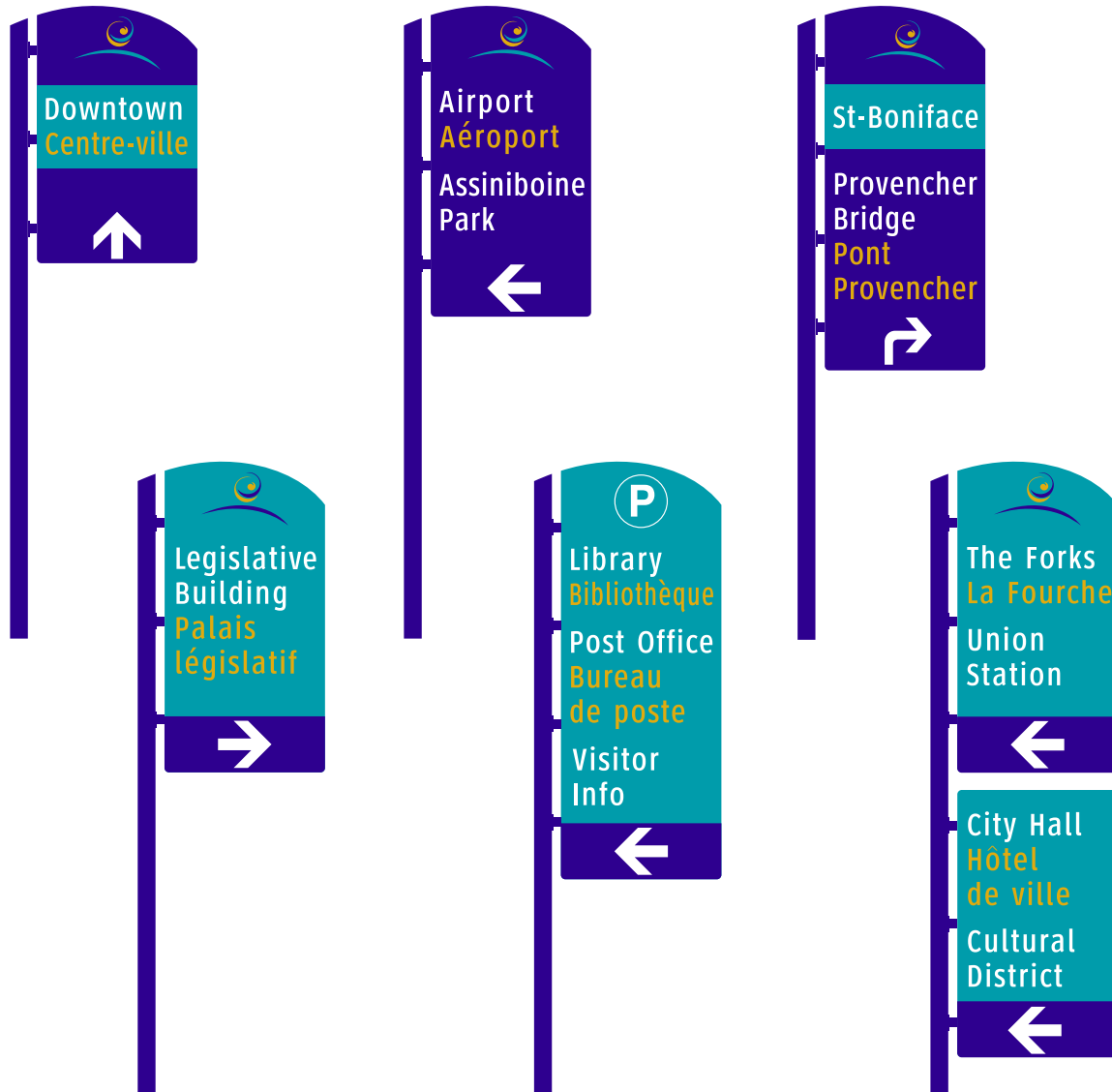

French translations are applied in traffic yellow reflective materials.
 French text follows English text as though part of same message
 with no additional spacing.



2738



3135



Standard Traffic Yellow

Logo & Pole Top Detail

Logo Position:

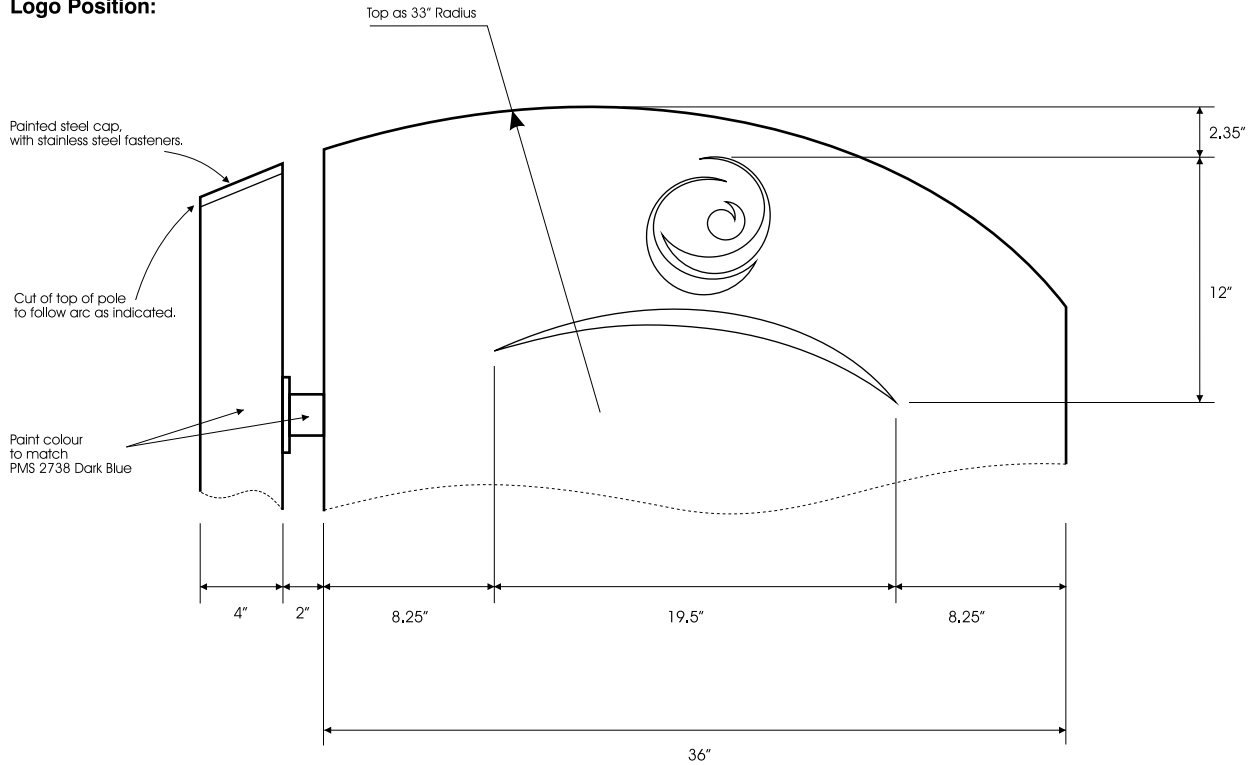

Logo Colours:



2738



3135



Standard Traffic Yellow

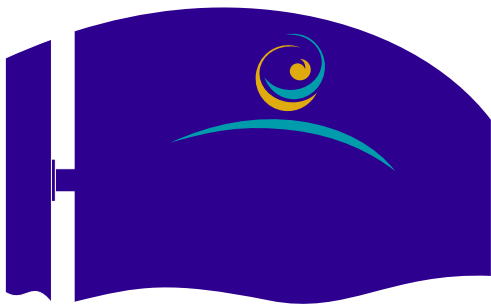

2738 background colour

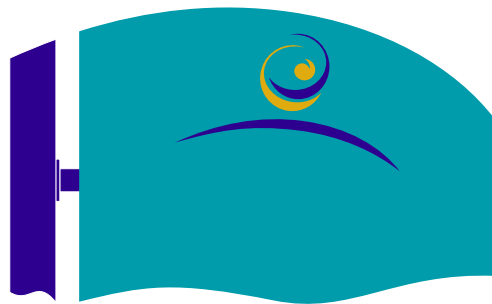

3135 background colour

Logo: All pieces cut from pre-coloured High Intensity Reflective material & positioned as indicated.

Note: Logos are not used on bottom sign of 2 sign installations.



Informing Design, Inc.

4 Smithfield St. 7th Floor
Pittsburgh, PA 15222
Phone 412-261-0446

City of Winnipeg
Traffic Wayfinder Sign System

"Kit of Parts" Design Details

Date 16 August, 2004

Drawing No. 2.03

Parking "P" Detail

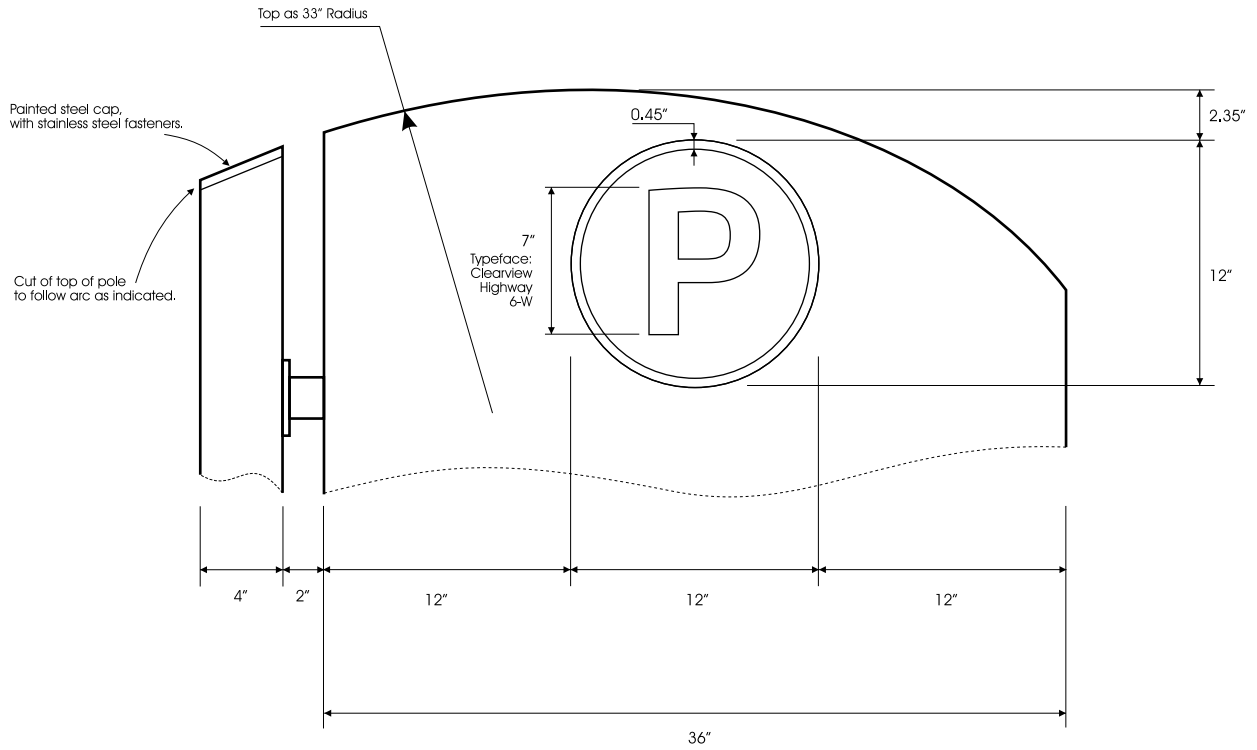

Sign Installation Type A Single — Inbound

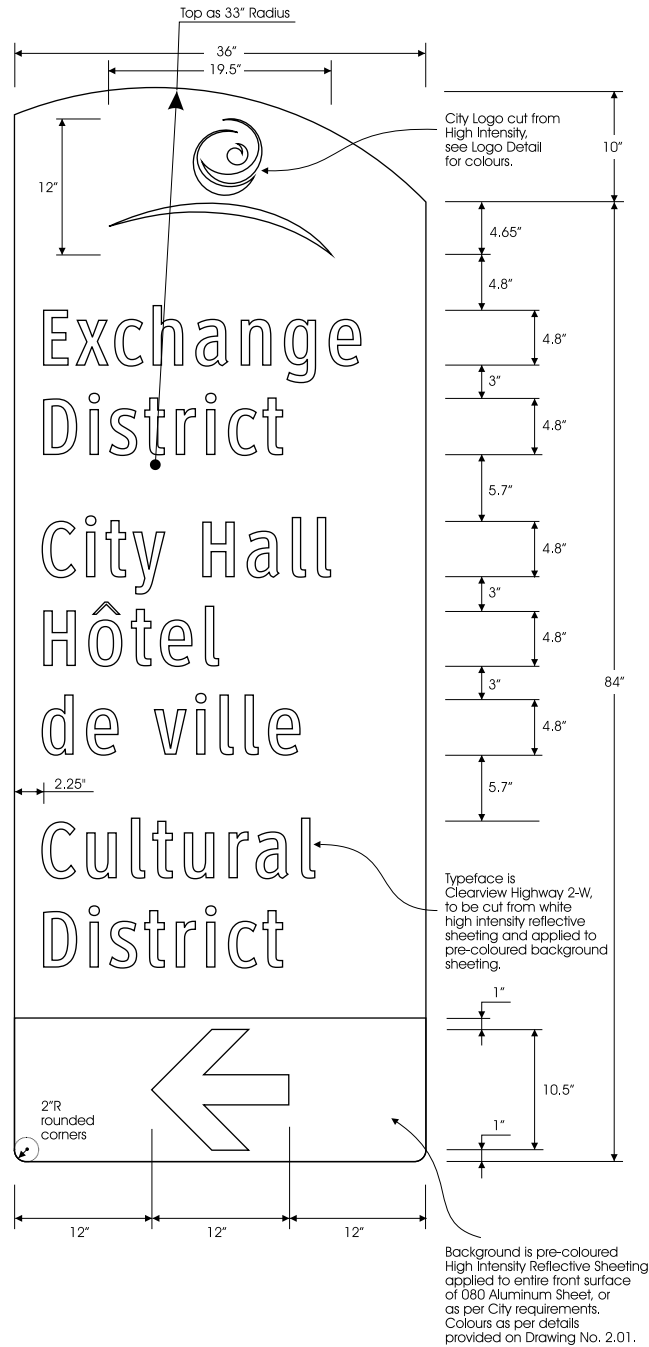

Sign Installation Type A Single — Outbound

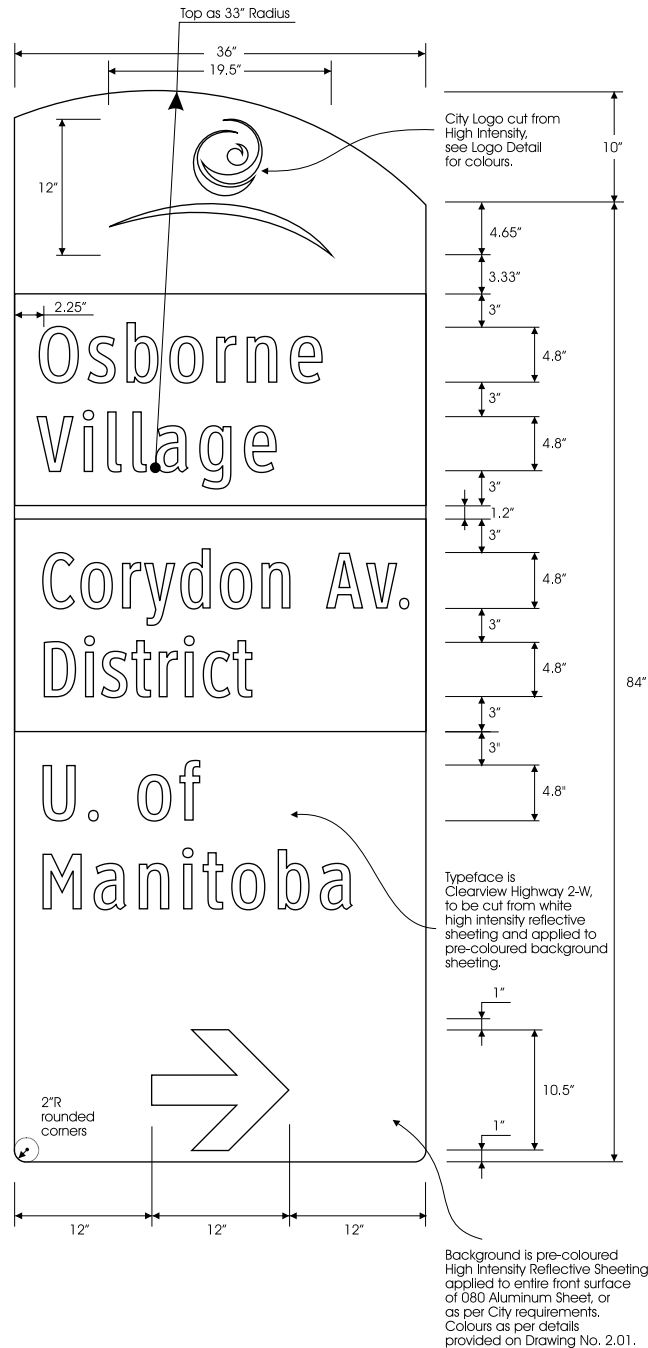

Sign Installation Type B Single — Outbound 2 bands

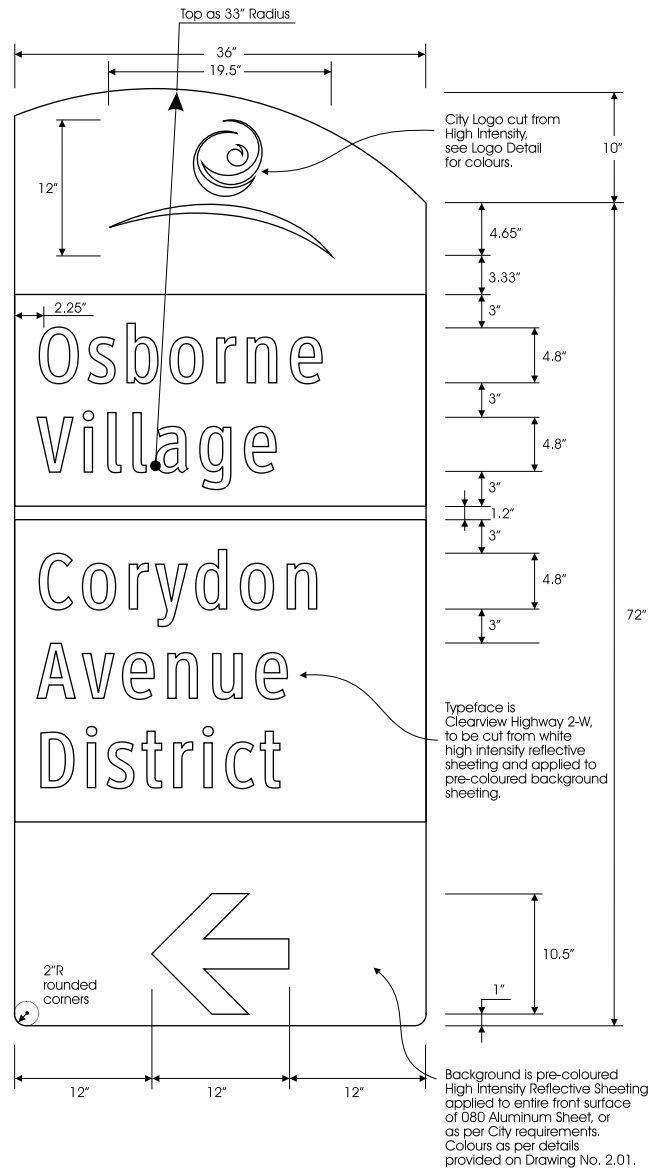

Sign Installation Type B Single — Outbound 1 band

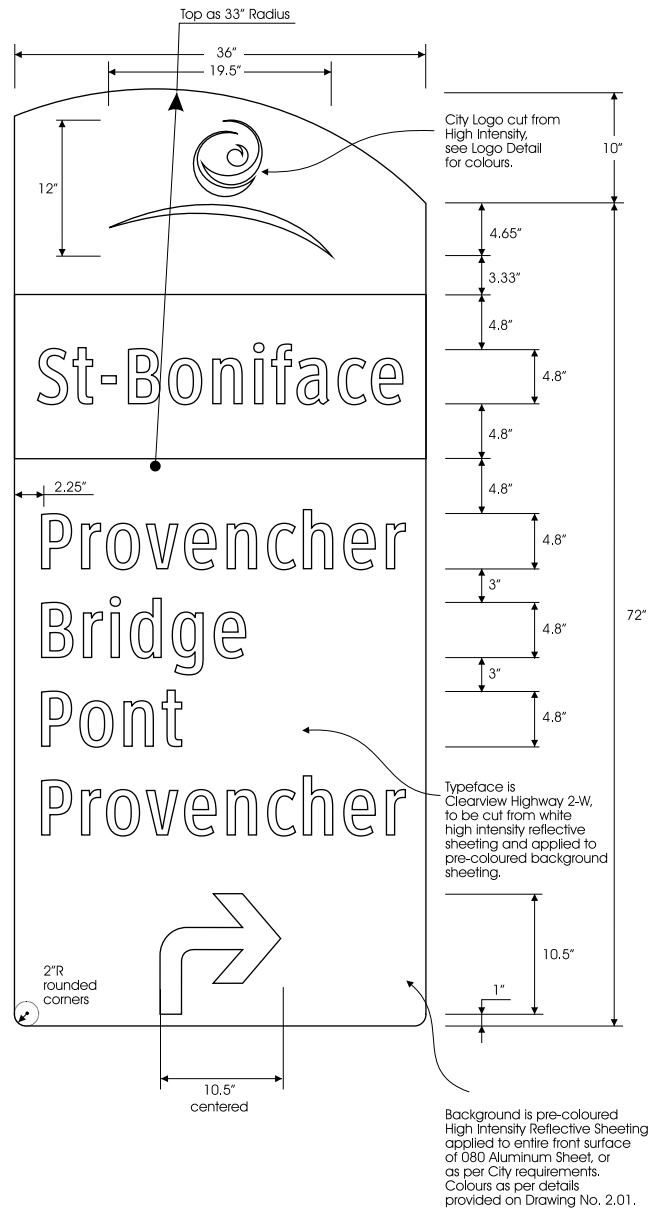

Sign Installation Type C Single

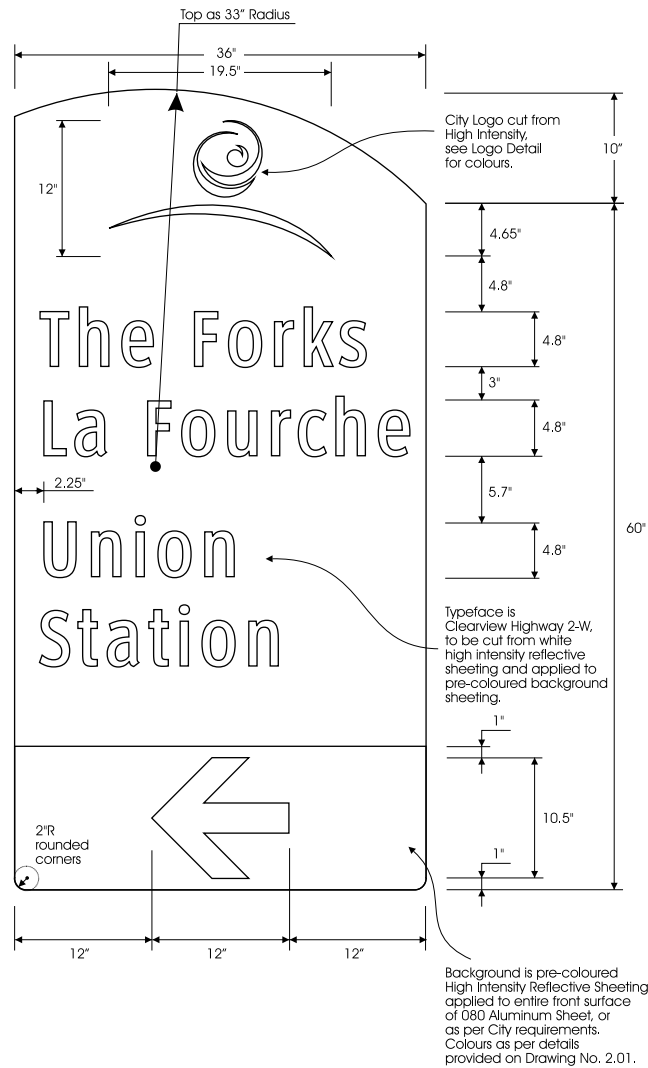

Sign Installation Type D Single

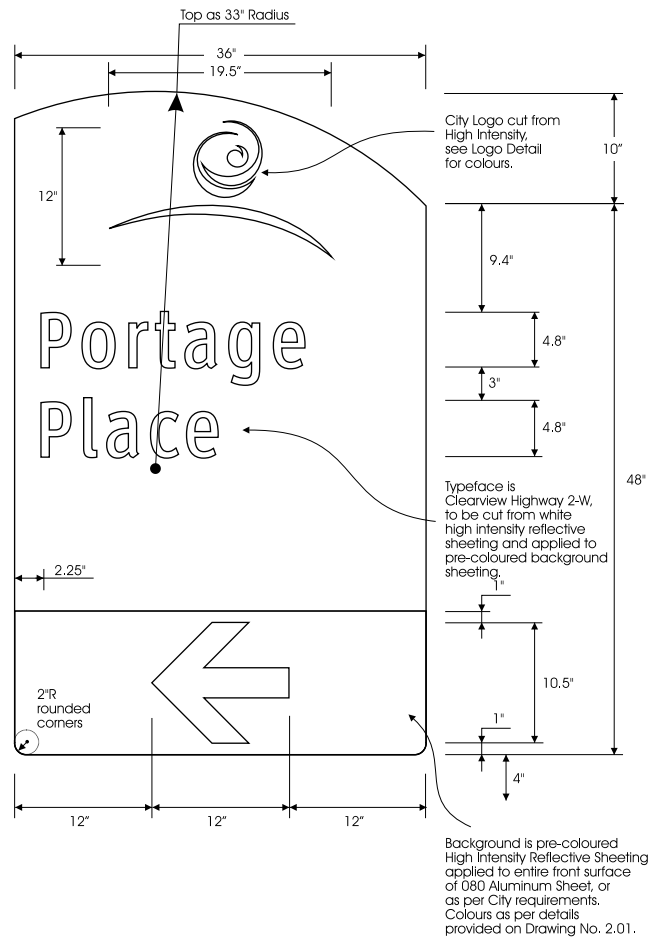

Sign Installation Type C+C Double — Inbound

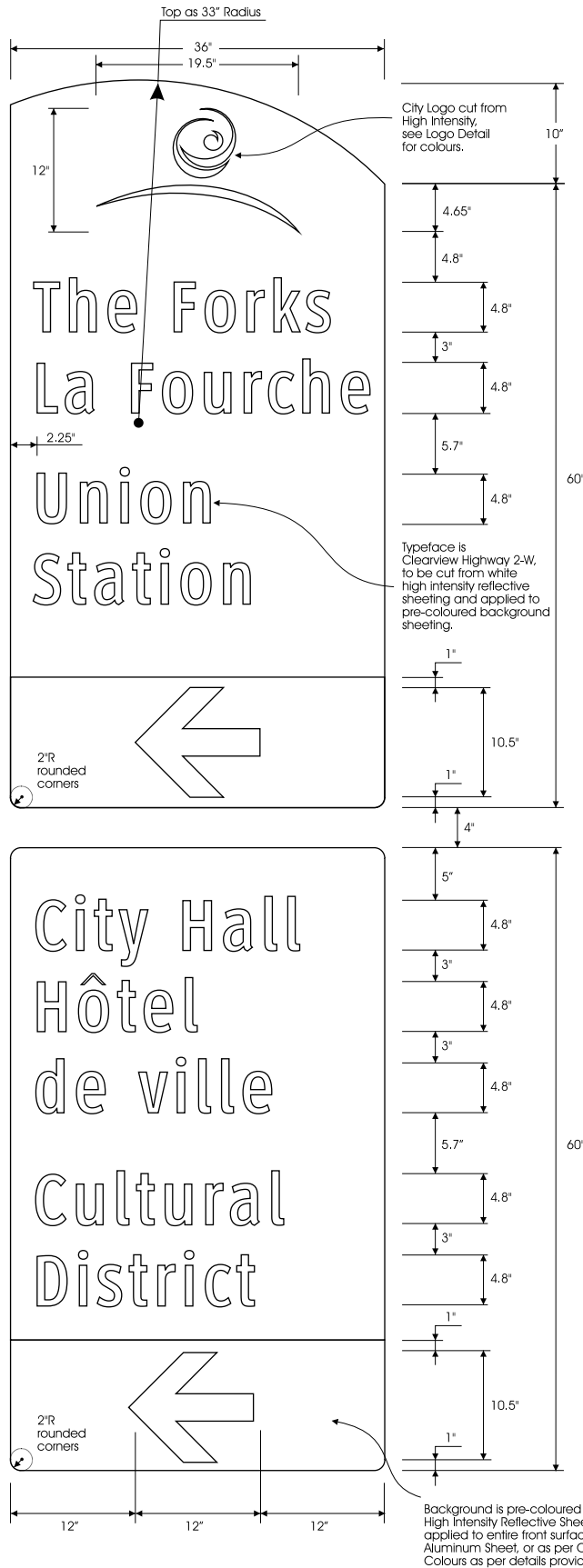

Sign Installation Type C+C Double — Outbound

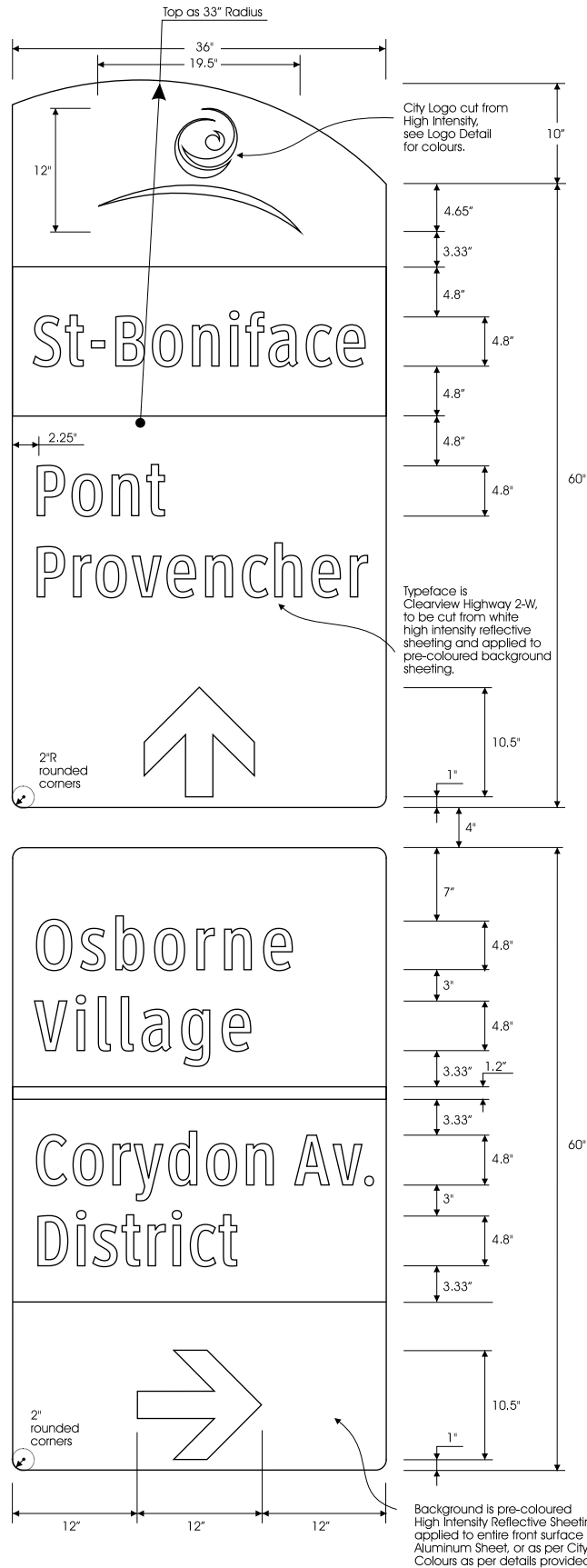

Sign Installation Type C+C Double — Outbound with Routes

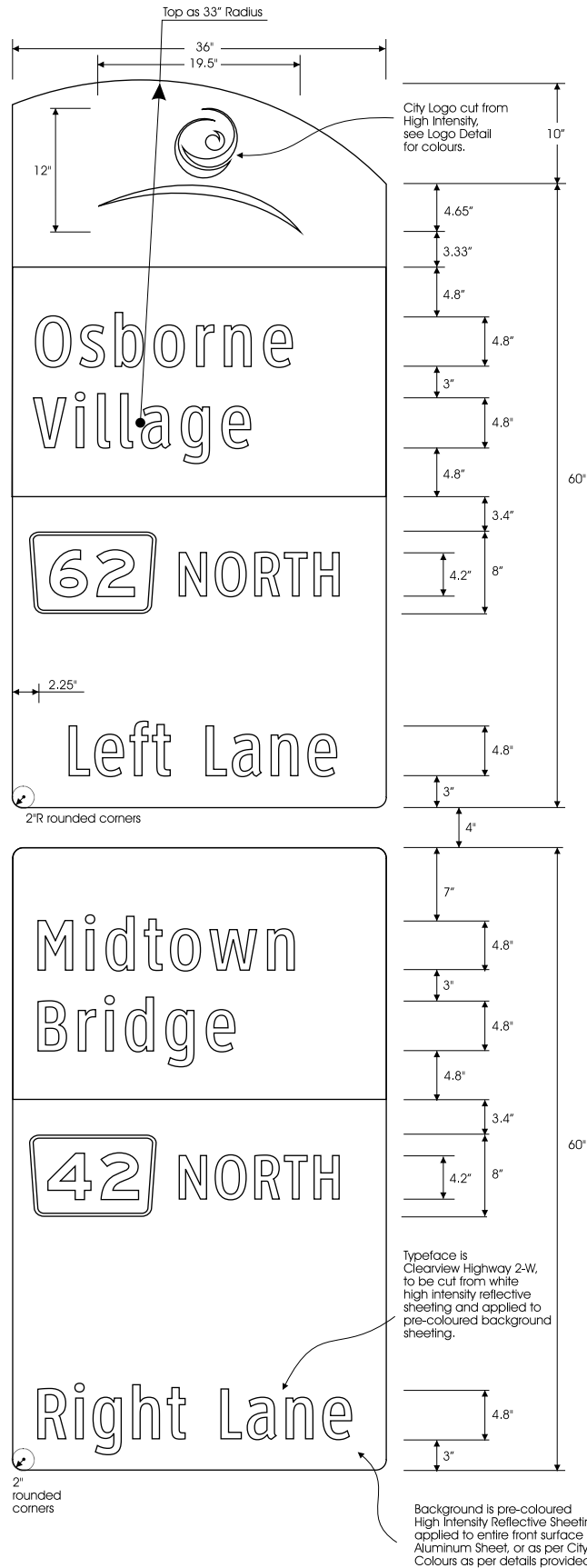

Sign Installation Type D+D Double

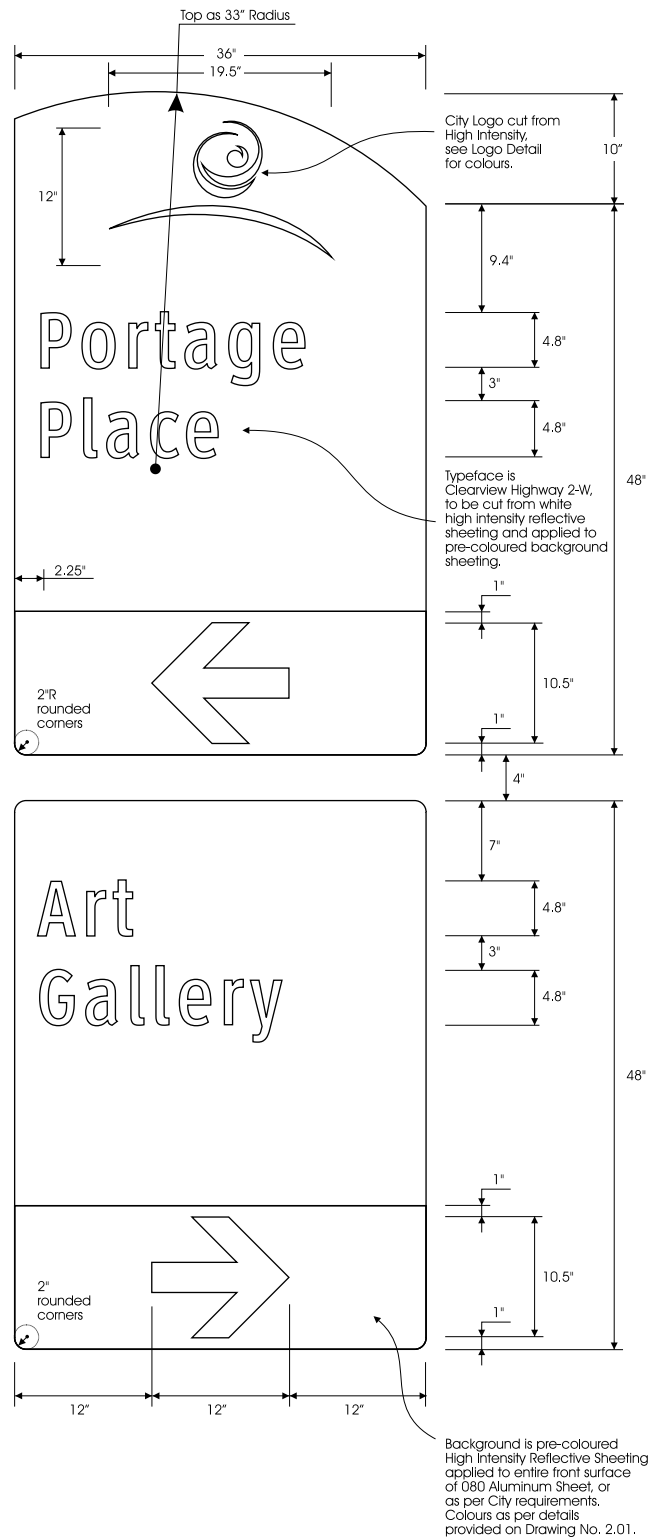

Sign Installation Type C+D Double

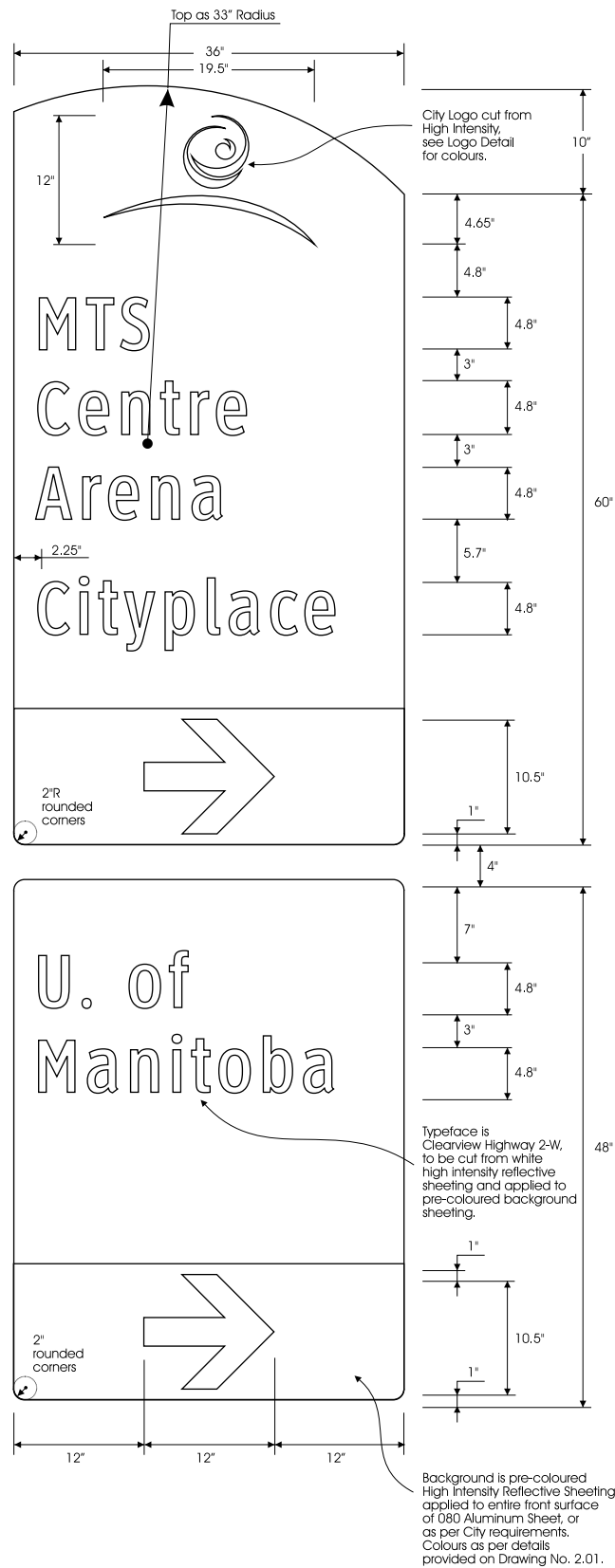

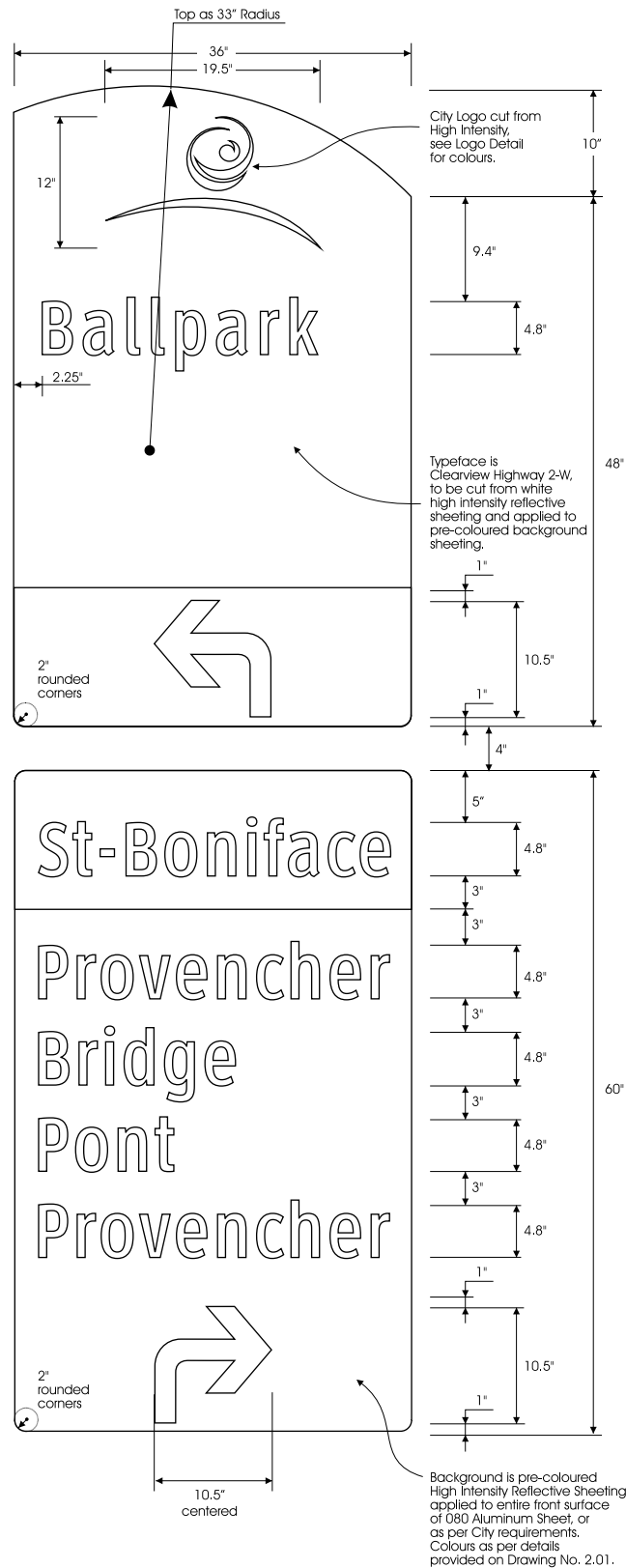

Sign Installation Type D+C Double

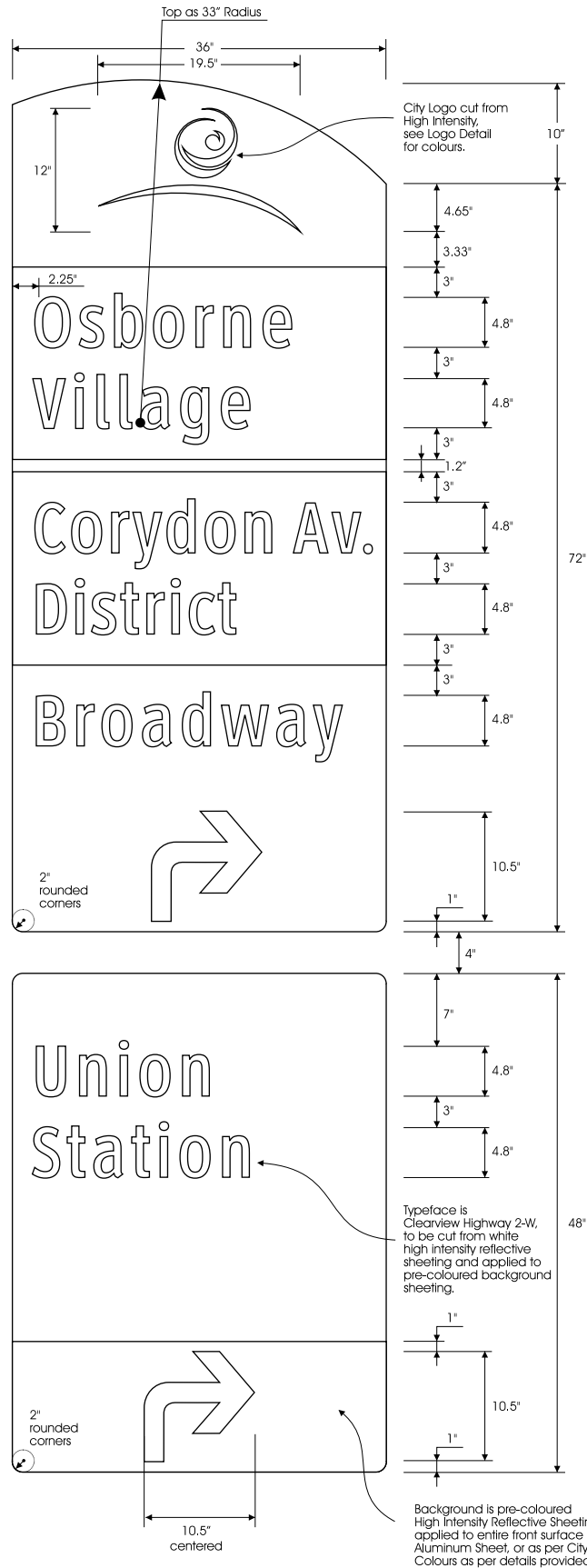

Sign Installation Type B+D Double

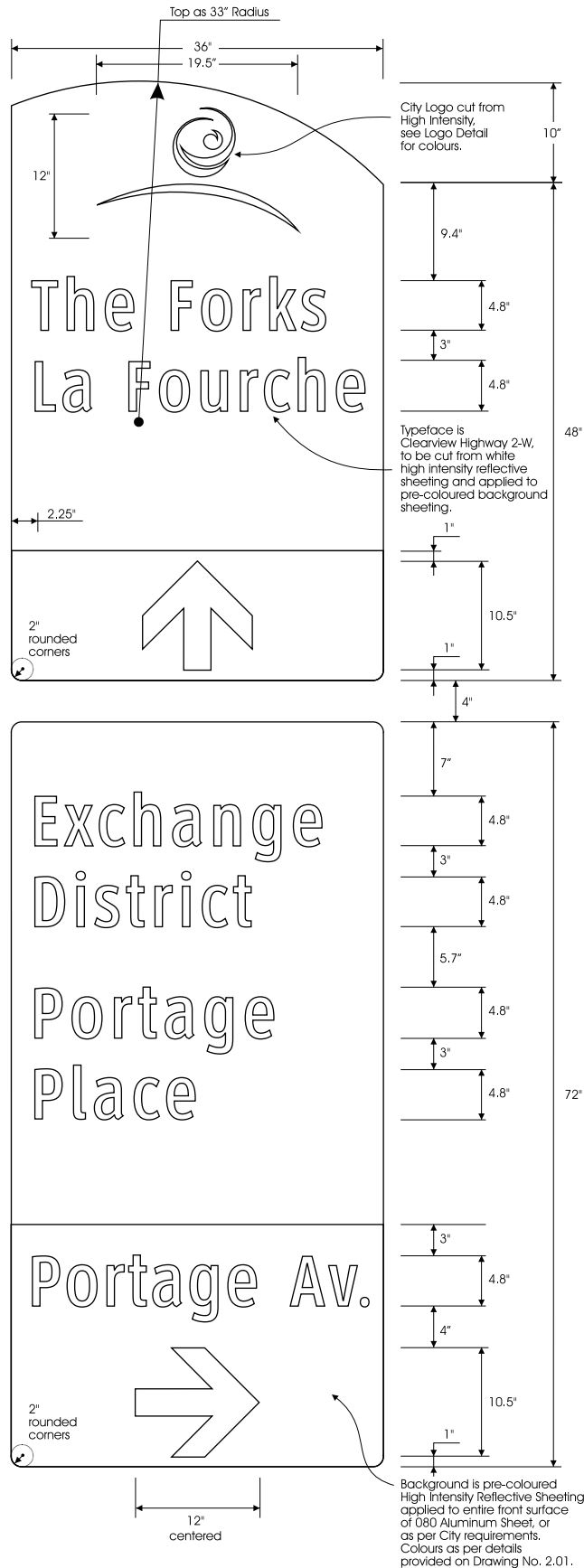

Sign Installation Type D+B Double

Informing Design, Inc.
4 Smithfield St. 7th Floor
Pittsburgh, PA 15222
Phone 412-261-0446

City of Winnipeg Traffic Wayfinder Sign System

"Kit of Parts" Design Details

Date 16 August, 2004

Drawing No. 2.18

Sign Installation — “You Are Here” Sign

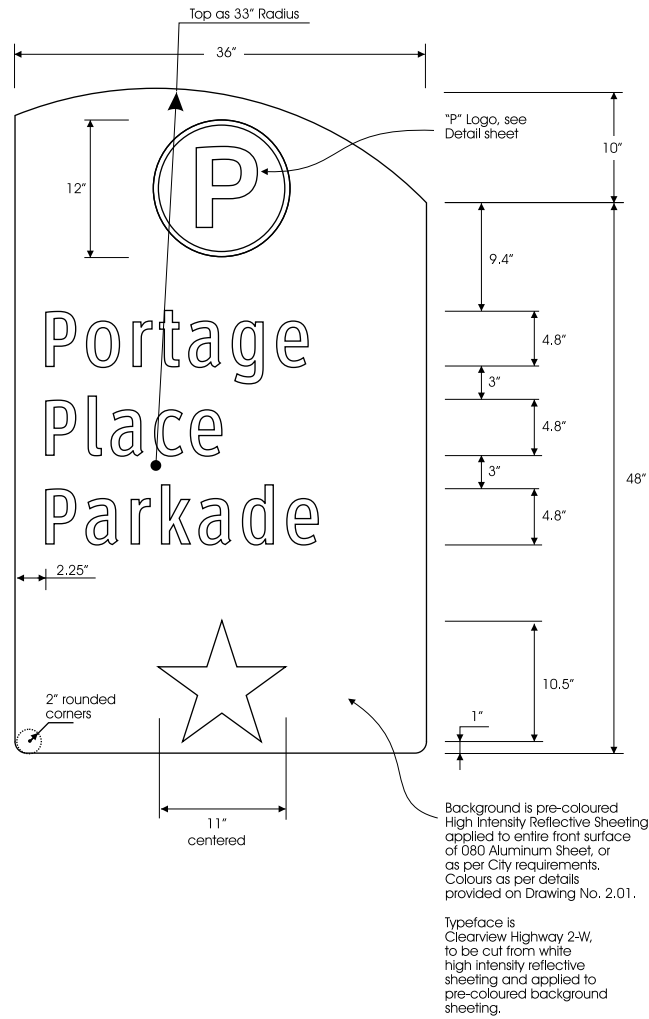

Sign Installation Type D Single — 45"

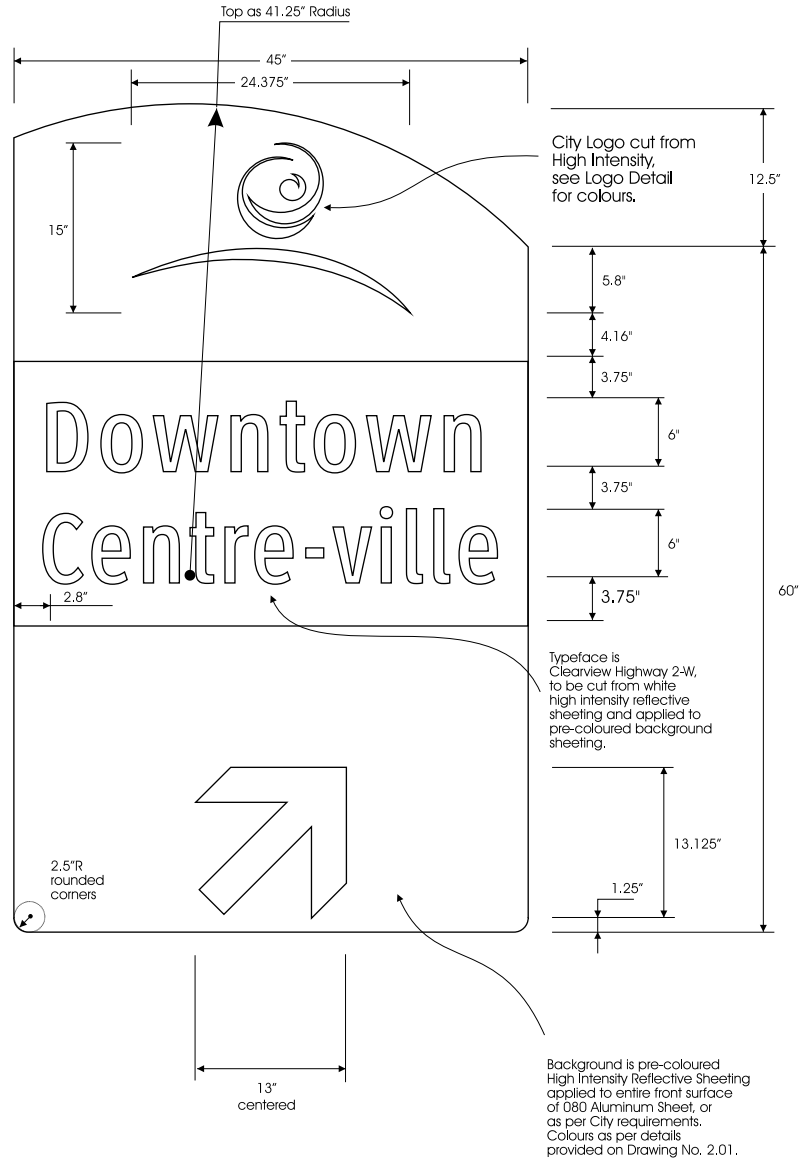

Informing Design, Inc.

4 Smithfield St. 7th Floor
Pittsburgh, PA 15222
Phone 412-261-0446

City of Winnipeg Traffic Wayfinder Sign System

"Kit of Parts" Design Details

Date 16 August, 2004

Drawing No. 2.20

Wayfinder Arrow Library



Arrow Straight

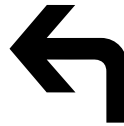

Bent Arrow Left

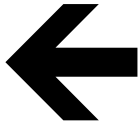

Arrow Left



Bent Arrow Right

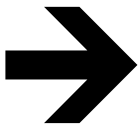

Arrow Right



Curved Arrow Left



Angeled Arrow Right



Curved Arrow Right



Back Angeled Arrow Right



Switchback Right



Angeled Arrow Left

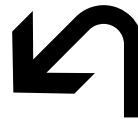

Switchback Left

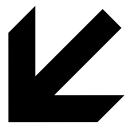

Back Angeled Arrow Left



Left-of-Island



Star ("You Are Here")



Informing Design, Inc.

4 Smithfield St. 7th Floor
Pittsburgh, PA 15222
Phone 412-261-0446

City of Winnipeg Traffic Wayfinder Sign System

"Kit of Parts" Design Details

Date 16 August, 2004

Drawing No. 2.21

Wayfinder Arrow Detail

Note:
All sizes are for 36" sign width. For 45" sign width scale up 125%.

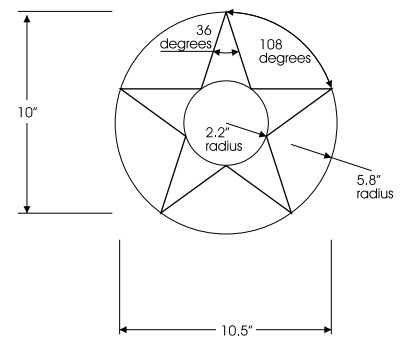
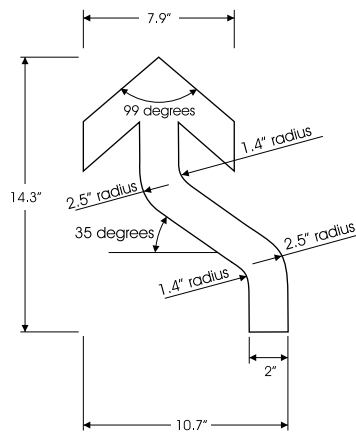
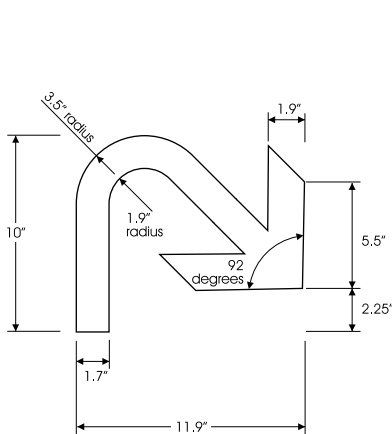
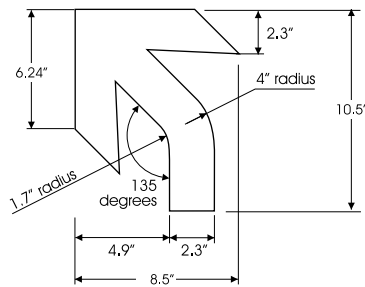
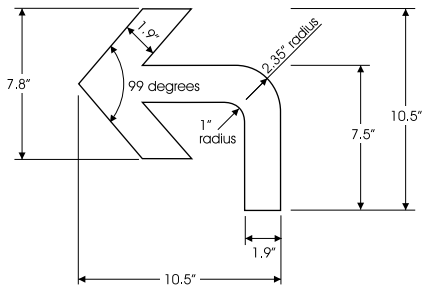
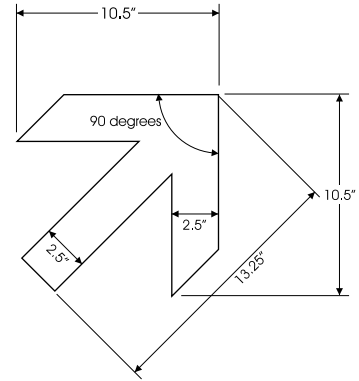
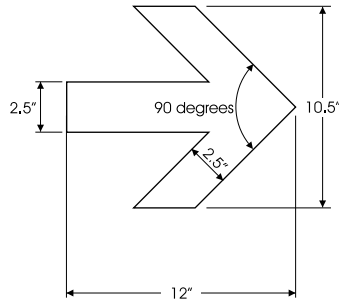
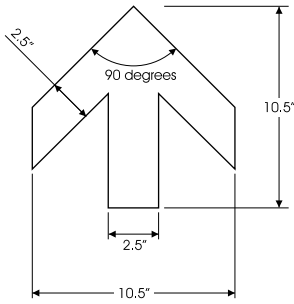

Informing Design, Inc.

4 Smithfield St. 7th Floor
Pittsburgh, PA 15222
Phone 412-261-0446

City of Winnipeg
Traffic Wayfinder Sign System

"Kit of Parts" Design Details

Date 16 August, 2004

Drawing No. 2.22

Sign Back for Box Sign Manufacturing Option

